

uvex



Safety Eyewear

protecting people

Product system planet series › Safety Eyewear

uvex has developed the **protecting planet** icon, to help raise awareness of its commitment to achieving increased sustainability. Based on the brand claim, **protecting people**, our sustainable approach integrates three core interlinked pillars – **ecology, economy** and **social responsibility**, that are incorporated throughout the business to improve our sustainability performance.

This explains the comprehensive audit, measurement and evaluation management process uvex undertakes along the entire value chain to ensure its products are as sustainable as possible.

uvex pheos nxt planet



Calculation date 02/2023*

MADE IN GERMANY

protecting planet
by using recycled material

Side arms

- › hard component made from 65 percent recycled material
- › soft component made from 47.4 percent recycled material, using waste from the recycling bin

Lens

- › 100 percent mass-balanced polycarbonate**

protecting planet
by using environmentally-friendly packaging

Films of polyester bags

- › up to 70 percent recycled material from production waste

Cartons

- › made of over 90 percent recycled paper



Lens
100%
 mass-balanced** PC

Hard components of
 side arms
65%
 from recycled material



9128295

Soft components of
 side arms
47.4%
 from post-consumer recycled material
 (PCR)



protecting planet

by reducing waste

Paper for instruction manuals

› 60 percent reduction

Packaging units

› increase from 5 to 10 pairs of spectacles reduces packaging material and causes less waste

** Mass balancing is a bookkeeping method that is used to record and track the mass flows of plastics, for example, along the entire value creation chain. In the manufacturing process, some fossil-based raw materials are replaced by more sustainable alternatives, for example through the use of biomass or recycled raw materials. The mass balancing approach enables manufacturers to verify the use of bio-based raw materials or recycle within a balance sheet period and to mathematically allocate the bio-based or recycled content to a proportion of the plastics produced, resulting in a material with a significantly lower CO₂ footprint. However, the exact proportion of bio-based or recycled material in the end product can no longer be precisely determined. At uvex, mass-balanced material is used in the lenses of the planet models, enabling a significant reduction in their CO₂ footprint. By purchasing mass-balanced polycarbonate, uvex is helping to replace fossil-based raw materials with bio-based materials.

The uvex brand is our responsibility

We have been producing and selling high-quality products for the protection of people in sport, leisure and work for **over 90 years**. And if you want to protect people, **you have to take responsibility**.

It is precisely from this mission that our obligation derives to act in a **sustainable, social and socially-responsible** manner.

uvex safety eyewear

Sustainability without compromising quality

In the PPE sector, the use of recycled or bio-based materials must not impair the protective properties under any circumstances – this makes the search for and use of sustainable materials a major challenge.

Nevertheless, we have succeeded in qualifying suitable recycled and bio-based (and, in some cases, mass-balanced**) materials, which can be processed and used in the manufacture of some of our top sellers:

Lenses
mass-balanced** PC made from bio-based raw materials

Side arms
recycled or bio-based material and PCR¹

Frame
recycled PET bottles or bio-based material³ as well as PCR¹ and PIR²

Coupling parts and headband hooks
recycled PET bottles

Soft face seal
recycled granulate (PIR²) and PCR¹

Headband
recycled yarn, bio-based material³ (headband slider)

The proportion of recycled, bio-based material varies from model to model, but always lies between

13.0% and 100%

This enables CO₂ savings of

29.0% up to 71.0%

Expanded range of replacement lenses

Conserving resources, reducing waste

Instead of disposing of all parts of the safety eyewear, we make it easy to replace the lens so that the frame can be used for longer. This enables us to save material and energy in production and contributes to sustainability and waste prevention.



Material and weight savings by using replacement lenses:

for spectacles, up to -44%

for goggles, up to -82%



Emissions transparency of our products

We take into account not only the emissions from our own production steps (Scope 1 and 2), but also the emissions from the production of the materials we use (Scope 3). The carbon footprint is the result of an emissions calculation of all greenhouse gases released by an activity. The effect that various greenhouse gases have on the climate is expressed in CO₂ equivalents (kg CO₂ eq)

Innovative safety eyewear — made in Germany

uvex safety eyewear centre of expertise

Innovative safety eyewear for the highest quality standards

In Fürth, Bavaria, uvex develops and produces first-class and highly functional safety spectacles, goggles, prescription spectacles and laser protection eyewear. The uvex plant is certified in accordance with ISO 9001:2015 and ISO 50001:2011, and relies on state-of-the-art technology and strategic partnerships to develop future-oriented technologies and products.



uvex safety eyewear greatly exceeds all requirements of the applicable standards.
Because good is not good enough for us.

Perfection as standard from uvex

All safety eyewear is comprehensively tested at the uvex test centre: As well as satisfying national and international safety standards, every item of safety eyewear also meets the exacting uvex standard in terms of functionality, ergonomics, durability and wearer comfort.

Innovative coating technologies are one of uvex's core competencies. The improved uvex supravision excellence universal coating exceeds the anti-fogging requirements of the EN 168 standard four times over.

New uvex product and innovation highlights



The product highlight:

With its great design, lightness and fit, the uvex pheos nxt is the perfect addition to our pheos family.

The innovation highlight:

With uvex IR-ex, uvex is offering safety eyewear with IR protection filters for the first time. The special feature of the filter is that it meets the requirements of multiple standards.



You can find more information about our new products on pages 14/15, 30/31 and 68/69.

Perfect vision for maximum safety

uvex coating expertise

It all comes down to the coating

Looking through lenses that are fogged up, scratched or dirty significantly increases the risk of accidents during the working day. uvex has been synonymous with innovative coating technologies for decades: In our centre of expertise in Fürth, we develop and produce scratch-resistant and anti-fog lenses for a multitude of applications.



The innovative coating technology makes uvex safety eyewear a reliable companion during day-to-day work — in a variety of applications.

Innovative manufacturing process

Conventional safety eyewear combines anti-fogging properties and scratch-resistance on both sides of the lens: This reduces the scratch-resistance and the anti-fogging effect is lessened by regular cleaning. Unlike conventional processes, the unique uvex process applies different coatings to either side of the lens.

Perfect vision whatever the situation

The outside of uvex lenses has an extremely scratch-resistant, chemical-resistant and easy-to-clean coating, while the inside is coated with a highly durable anti-fog effect — for perfect vision and maximum safety. Lenses are also available with an extremely scratch-resistant or anti-fog coating on both sides — depending on the working environment.

uvex supravision excellence — next level performance

uvex has further improved its proven uvex supravision excellence coating technology once again: All lenses now offer twice the performance in terms of anti-fogging time, exceeding the requirements of the EN 168 standard four times over.

dry 0% RH



uvex supravision excellence

Interior	Performance	Exterior
▲▲▲▲	Anti-fog	△△△△
▲▲▲△	Scratch-resistance	▲▲▲▲

- Unique dual-action permanent anti-fog coating on the interior of the lens and a scratch-resistant hard coating on the exterior. This allows each coating to perform at maximum efficiency.
- extremely scratch-resistant and chemical-resistant on the outside of the lens with non-stick, easy to clean technology
- long lasting anti-fog performance on the inside
- anti-fog performance will not diminish even after repeated cleaning
- suitable for a wide range of workplaces

cold -20°C



uvex supravision plus

Interior	Performance	Exterior
▲▲▲▲	Anti-fog	▲▲▲▲
▲▲▲△	Scratch-resistance	▲▲▲△

- long lasting anti-fog performance and scratch-resistance on both sides
- anti-fog performance will not diminish even after repeated cleaning
- suitable for environments where there is high humidity and/or frequent temperature fluctuations



scan for QR-Code for further information.
uvex-safety.com/en/antifog

Find your ideal lens coating

1. Select the **temperature** which best represents your working environment on the **horizontal temperature axis**.
2. Define the **air humidity** of your environment in percentage terms and find the value on the **diagonal axis**.
3. Determine the **level of dirt** on the **vertical axis**.
4. Connect these three points to form a triangle.
5. The part of the triangle with the **largest area** indicates the lens coating most suited for your workplace.



Coating technology

Core Coatings

dirty

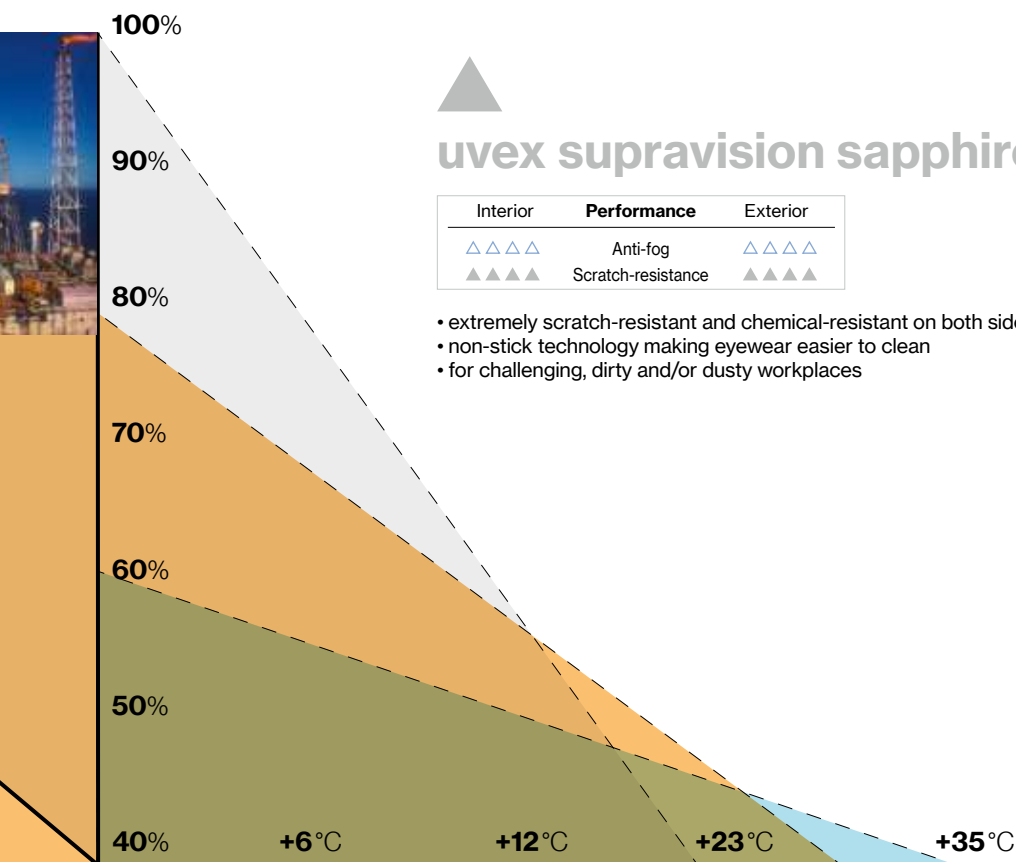

hot +35°C



clean



wet 100% RH

Coating technology

Special Coatings



scan for QR-Code
for further information
uvex-safety.com/en/antifog

uvex supravision extreme

Interior	Performance	Exterior
▲▲▲▲	Anti-fog	△△△△
▲▲▲△	Scratch-resistance	▲▲▲▲

Interior:

- durable, permanent anti-fog performance
- coating forms a thin veil of water without impairing vision

Exterior:

- extremely scratch-resistant, chemical-resistant and easy to clean

Areas of application:

- prolonged exposure to high risk of fogging and dirt

uvex supravision ETC (extreme temperature conditions)

Interior	Performance	Exterior
▲▲▲▲	Anti-fog	▲▲▲▲
▲▲▲△	Scratch-resistance	▲▲▲△

Interior and exterior:

- durable, permanent anti-fog performance
- coating forms a thin veil of water in humid environments without impairing vision

Areas of application:

- workplaces with high humidity and/or frequent temperature fluctuations

uvex supravision clean

Interior	Performance	Exterior
▲▲▲△	Anti-fog	△△△△
▲▲▲△	Scratch-resistance	▲▲▲▲

Specifically developed for the health care sector. Lenses with uvex supravision clean are autoclavable.

Interior:

- lasting anti-fog performance
- anti-fog performance lasts a minimum of 20 autoclave cycles

Exterior:

- extremely scratch-resistant, chemical-resistant and easy to clean

Areas of application:

- dry, clean environments

uvex supravision variomatic

Interior	Performance	Exterior
▲▲▲▲	Anti-fog	△△△△
▲▲▲△	Scratch-resistance	▲▲▲▲

Self-tinting coating that darkens when exposed to UV. Benefits from highly effective anti-fog performance inside, extremely scratch-resistant on the outside.

Self-tinting coating:

- automatically darkens within 10 sec. and lightens within 30 sec.

Areas of application:

- frequent moves between indoor and outdoor environments or light and dark workspaces

uvex supravision infradur

Interior	Performance	Exterior
△△△△	Anti-fog	△△△△
▲▲▲▲	Scratch-resistance	▲▲▲▲

Specifically developed for welding applications. Extremely high scratch-resistance on both sides. Minimises burns from welding sparks.

Areas of application:

- suitable for very dirty, dry welding applications where there is minimal risk of fogging

uvex supravision infradur plus

Interior	Performance	Exterior
▲▲▲▲	Anti-fog	△△△△
▲▲▲△	Scratch-resistance	▲▲▲▲

Specifically developed for welding applications. Lasting anti-fog performance on the inside, extremely scratch-resistant outside and minimises burns from welding sparks.

Areas of application:

- suitable for dirty, welding environments with a high possibility of fogging



The new standard for safety eyewear

EN ISO 16321

Unpacking the new standard and what it means for your safety eyewear

For more than 20 years, the EN 166 standard has defined all of the requirements and standards for safety eyewear within the European Union and the United Kingdom. EN 166 is now being replaced by EN ISO 16321. The new standard contains a range of international standards that will entail some significant changes to product requirements and test methods.

Entry into force and transition period

In May 2023, EN ISO 16321 was formally published in the Official Journal of the European Union as a harmonised standard and replacement for EN 166. **The legal introduction of the new standard will take effect in November 2024.** From this date, products may only be tested and certified by official bodies in accordance with the new EN ISO 16321 standard.

However, existing **certificates based on EN 166 will remain** valid until their respective official expiry dates, **but for a maximum of five years.** This means that products that are certified or recertified in accordance with EN 166 by 31 October 2024 may be labelled and placed on the market in accordance with EN 166 until 31 October 2029. During this **transition period, safety eyewear in accordance with both EN 166 and EN ISO 16321** will be available on the market. For dealers, by contrast, there is no end date by which they must have sold their EN 166-certified products!

Scope and background

The ISO was established primarily for **updating** and adapting **already defined tests and test methods** to match the current technological standards. It is also designed to achieve, where possible, **the global harmonisation** of the various PPE standards in force in different regions of the world. When defining the requirements and test methods, ISO has taken all international standards currently in force (e.g. AS/NZS, ANSI etc.) into account and has incorporated elements of them into the unified and harmonised standard ISO 16321. However, member countries are free to choose whether to apply the new ISO standard or to maintain their existing, currently applicable national standards. In the future, this will allow for greater consistency in international product markings **and universal minimum standards.**

In the European Union and the United Kingdom, EN ISO 16321 will replace the current standard EN 166 when it comes into force. Other international PPE markets may follow in the future.

The following pages contain an overview of the markings set out by EN 166 and EN ISO 16321.

If you have any questions, please do not hesitate to contact our customer service.

EN ISO 16321 – The most important changes at a glance:

- EN ISO 16321 includes EN ISO 16321-1 (general requirements; UV, sunglare and IR filters), EN ISO 16321-2 (welding protection filters) and EN ISO 16321-3 (mesh visors).
- The markings for all safety eyewear and visors will be updated. As a result, new certificates will be required for all affected products.
- New test heads and coverage areas have been defined, and certification of different head sizes (S, M, L) is now also permitted.
- The mechanical strength for goggles and face protection will be reduced to 80 m/s and 120 m/s (previously 120 m/s and 190 m/s).
- Additional, optional tests for e.g. chemical resistance, liquid flows and electrostatic discharges are made possible.
- Various tests and markings will be limited to certain product areas, e.g. it will only be possible to use marking 9 (protection against molten metals) for visors.



Further information about EN ISO 16321 and more detailed information about the changes can be found on our blog:

Scan the QR code for more information.
uvex-safety.com/blog/new-protective-eyewear-standards-en-iso-163212022/



Markings in accordance with EN 166

Markings on lenses in accordance with EN 166

Filter	
2	UV protection filter (EN 170)
2C/3	UV protection filter with colour recognition (EN 170)
4	IR protection filter (EN 171)
4C	IR protection filter with colour recognition (EN 171)
5	Sunglare filter for industrial use (EN 172)
6	Sunglare filter with infrared requirement (EN 172)

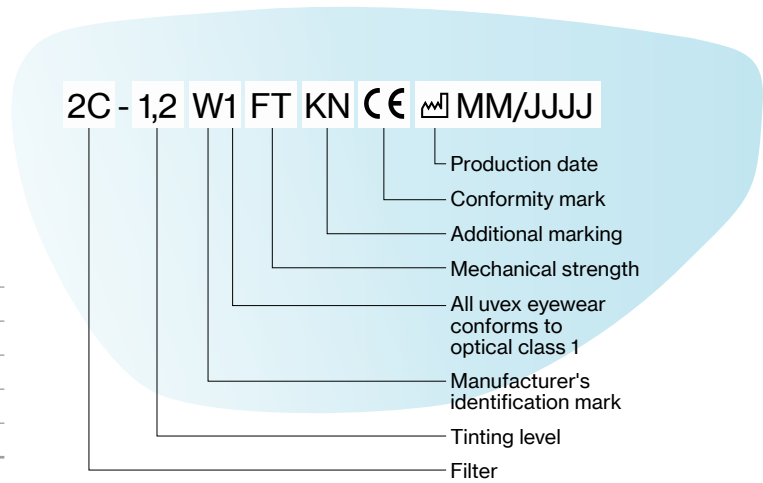

Tinting levels

Marking	Light transmittance	Available uvex tints
1,2	74.4–100%	AR, clear, amber
1,4	58.1–80%	CBR65
1,7	43.2–58.1%	Silver mirror 53%
2,5	17.8–29.1%	CBR23, grey 23%
3,1	8–17.8%	Grey 12%, silver mirror 12%, polavision
1,7	43.2–58.1%	Welding shade level 1,7
3	8.5–17.8%	Welding shade level 3
5	1.2–3.2%	Welding shade level 5
1,7	43.2–58.1%	Infrared protection IR-ex level 1,7
3	8.5–17.8%	Infrared protection IR-ex level 3
5	1.2–3.2%	Infrared protection IR-ex level 5

Mechanical strength

None	Minimum robustness (filters only)
S	Increased robustness
F	Low-energy impact (45 m/s or 162 km/h)
B	Medium-energy impact (120 m/s or 432 km/h)
A	High-energy impact (190 m/s or 684 km/h)
T	Tested under extreme temperatures (-5°C/+55°C)

Additional markings*

K	Surface resistance to damage by small particles in accordance with EN 168 (scratch resistance)
N	Resistance to fogging in accordance with EN 168
8	Protection against short-circuit electric arcs
9	Protection against molten metal and hot solids

Markings on frames in accordance with EN 166

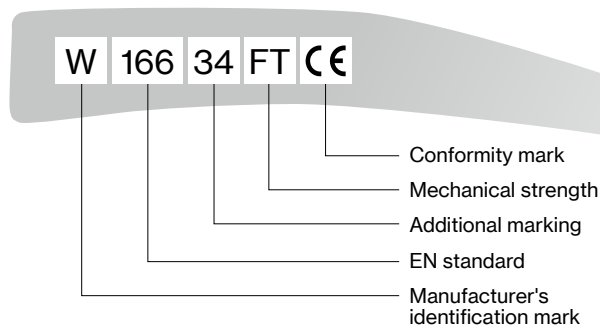

Additional markings*

None	General use
3	Protection against liquids (drops and splashes)
4	Protection against large dust particles with a grain size of > 5 µm
5	Protection against gases, vapours, smoke, fumes and fine dust particles with a grain size of < 5 µm
8	Protection against short-circuit electric arcs (visors only)
9	Protection against molten metal and hot solids

Mechanical strength

None	Minimum robustness (filters only)
S	Increased robustness
F	Low-energy impact (45 m/s or 162 km/h)
B	Medium-energy impact (120 m/s or 432 km/h)
A	High-energy impact (190 m/s or 684 km/h)
T	Tested under extreme temperatures (-5°C/+55°C)

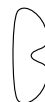

Markings in accordance with EN ISO 16321

Markings on lenses in accordance with EN ISO 16321

Filter

U	UV protection filter
G	Sunglare filter
W	Welding protection filter
R/RR	Infrared protection filter
+L	Signal light detection (optional, can be additionally certified for each filter)

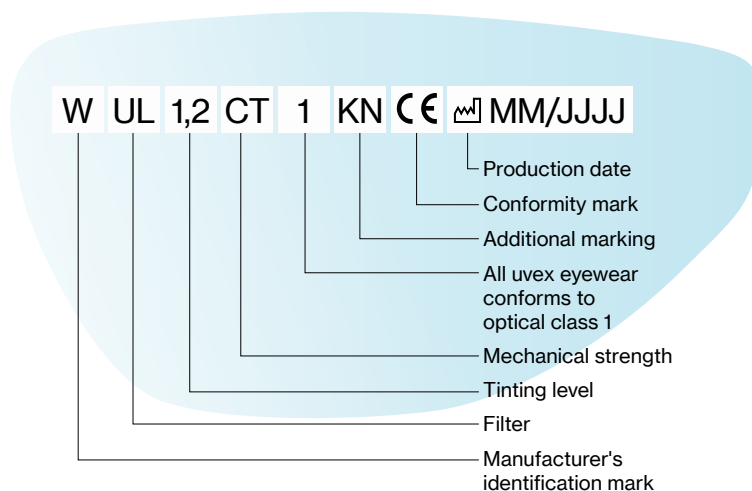

Tinting levels

Marking	Light transmittance	Available uvex tints
U1,2	74.4–100%	AR, clear, amber
G1	43.2–80%	CBR65, silver mirror 53%
G2	17.8–43.2%	CBR23, grey 23%
G3	8–17.8%	Grey 12%, silver mirror 12%, polavision
W1,7	43.2–58.1%	Welding shade level 1,7
W3	8.5–17.8%	Welding shade level 3
W5	1.2–3.2%	Welding shade level 5
RL1,7	43.2–58.1%	Infrared protection IR-ex level 1,7
RL3	8.5–17.8%	Infrared protection IR-ex level 3
RL5	1.2–3.2%	Infrared protection IR-ex level 5

Mechanical strength

None	Drop ball test in accordance with EN ISO 16321 (basic requirement)
C	Low-energy impact (45 m/s or 162 km/h)
D	Medium-energy impact (80 m/s or 288 km/h)
E	High-energy impact (120 m/s or 432 km/h)
HM*	High-mass impact (500 g steel projectile, drop height 1.27 m)
T*	Tested under extreme temperatures (-5°C/+55°C)

Additional markings*

K	Surface resistance to damage by small particles in accordance with EN ISO 16321 (scratch resistance)
N	Resistance to fogging in accordance with EN ISO 16321
7	Protection against radiant heat
9	Protection against molten metal and hot solids
CH	Chemical resistance

Markings on frames in accordance with EN ISO 16321

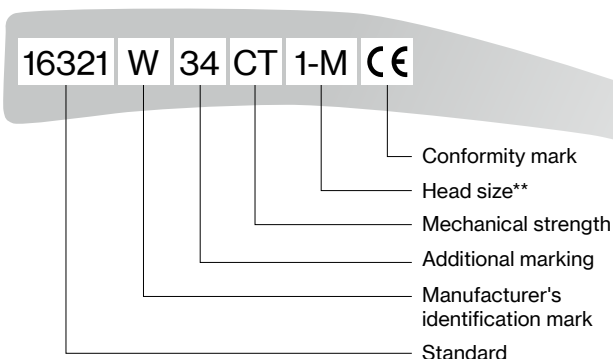

Mechanical strength

None	Drop ball test in accordance with EN ISO 16321 (basic requirement)
C	Low-energy impact (45 m/s or 162 km/h)
D	Medium-energy impact (80 m/s or 288 km/h)
E	High-energy impact (120 m/s or 432 km/h)
HM*	High-mass impact (500 g steel projectile, drop height 1.27 m)
T*	Tested under extreme temperatures (-5°C/+55°C)

Additional markings*

3	Protection against liquids (drops and splashes)
4	Protection against large dust particles with a grain size of > 5 µm
5	Protection against gases, vapours, smoke, fumes and fine dust particles with a grain size of < 5 µm
6	Protection against high-pressure liquid flows
7	Protection against radiant heat (visors only)
8	Protection against short-circuit electric arcs (visors only)
9	Protection against molten metal and hot solids (visors only)
CH	Chemical resistance

Head sizes

1-S	Small, European test head
1-M**	Medium, European test head (standard)
1-L	Large, European test head
2-S	Small, Asian test head
2-M	Medium, Asian test head
2-L	Large, Asian test head

* Optional

** 1-M is the standard. If only 1-M has been tested, this does not have to be marked on the frame or on the packaging.

Lens tinting

A lens solution for every light environment



CLEAR

Protection: UV400
Marking: 2(C)-1.2
Transmission: approx. 91%

Protection against **mechanical hazards** without **glare**

Standards: EN 166, EN 170; EN ISO 16321, UV protection filter



AMBER

Protection: UV400
Marking: 2(C)-1.2
Transmission: approx. 88%

Protection against **mechanical hazards** without **glare**, with **contrast enhancement**

Standards: EN 166, EN 170; EN ISO 16321, UV protection filter



CBR65

Protection: UV400
Marking: 5-1.4
Transmission: approx. 65%

Protection **offering relaxing, focused vision**

Standards: EN 166, EN 172; EN ISO 16321, Sunglare filter

- uvex pheos nxt (p. 31), uvex i-5 (p. 39), uvex sportstyle (p. 42), uvex pheos cx2 (p. 43), uvex super f OTG (p. 59), uvex pheos cx2 sonic (p. 61)



AR (anti-reflective)

Protection: UV400
Marking: 2(C)-1.2
Transmission: approx. 96.5%

Optimum **anti-reflective** protection with high degree of light transmission

Standards: EN 166, EN 170; EN ISO 16321, UV protection filter

- uvex sportstyle (p. 42), uvex i-3 (p. 46)

tint with glare protection not necessary ←



74–100%
transmission



58–80%
transmission

Lens tinting



CBR23

Protection: UV400
Marking: 5-2.5
Transmission: approx. 23%

Protection against **natural glare** with **signal colour recognition** and **increased contrast effect**

Standards: EN 166, EN 172; EN ISO 16321, Sunglare filter

► uvex pheos nxt (p. 31), uvex i-5 (p. 39), uvex sportstyle (p. 42), uvex pheos cx2 (p. 43), uvex megasonic (p. 60)



POLAVISION

Protection: UV400
Marking: 5-3.1
Transmission: approx. 14%

Reduction of irritating surface reflection by **filtering scattered light**

Standards: EN 166, EN 172; EN ISO 16321, Sunglare filter

► uvex polavision (p. 56)

tint with contrast adjustment recommended



SILVER MIRROR 53%

Protection: UV400
Marking: 5-1.7
Transmission: approx. 53%

Protection in **changing light conditions**

Standards: EN 166, EN 172; EN ISO 16321, Sunglare filter

► uvex pheos (p. 44), uvex i-works (p. 49)



SILVER MIRROR 12%

Protection: UV400
Marking: 5-3.1
Transmission: approx. 12%

Protection from both highly **artificial light and natural glare conditions**

Standards: EN 166, EN 172; EN ISO 16321, Sunglare filter

► uvex sportstyle (p. 42), uvex pheos cx2 (p. 43), uvex i-3 (p. 46)

tint with contrast adjustment not necessary



GREY 23%

Protection: UV400
Marking: 5-2.5
Transmission: approx. 23%

Protection against **natural glare** with **signal colour recognition**

Standards: EN 166, EN 172; EN ISO 16321, Sunglare filter



GREY 12%

Protection: UV400
Marking: 5-3.1
Transmission: approx. 12%

Protection against **natural glare** with **signal colour recognition**

Standards: EN 166, EN 172; EN ISO 16321, Sunglare filter

► uvex pheos cx2 (p. 43)

tint with contrast adjustment not necessary

tint with glare protection recommended



uvex UV400

100% UV protection. 100% safety. 100% uvex.

The EN166/170 standard requires safety eyewear to provide UV protection up to 380 nm. The latest scientific findings show that this is not enough. The WHO (World Health Organization) recommends UV protection up to 400 nm.



“The reasons why the WHO recommends UV400 protection are clear. The outer tissues of the eye, cornea and lens fully absorb UV light. While UVB light primarily damages the genetic material, UVA rays penetrate deeper, cause thermal damage and magnify the effects of UVB light.”

Univ.-Prof. Dr. rer. nat. Olaf Strauß



uvex UV400 – included in all uvex safety eyewear

Whether you choose clear or tinted lenses, all uvex safety spectacles are equipped with uvex UV400 effective UV protection as standard – as well as pleasant wearer comfort, a sporty design and top-quality lens coatings.

Even without sun, UV rays can still put strain on the eye

When working outdoors, your eyes are regularly exposed to harmful UV radiation – even when it is cloudy. The result: using insufficient protection risks may cause dangerous long-term damage such as corneal injury, cataracts and blindness.

100% protection against dangerous UVA and UVB radiation

For the eye and surrounding skin

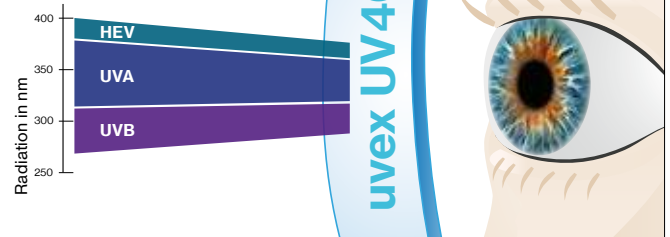

uvex UV400 offers complete protection against UVA and UVB radiation as well as high-energy visible light (HEV) up to a wavelength 400 nm.

uvex UV400 not only filters 100% of UVA rays (20% still passes through 380 nm lenses), it also completely minimises temperature-induced cell changes – a factor which increases tenfold in the percentage of total cell damage in the range from 380 to 400 nm. In addition, the dangerous, damaging blue light content (HEV), which is also harmful to the retina, is reduced by 15%.

uvex safety eyewear,
100% safety.





uvex CBR65 · uvex CBR23

Fatigue-free, comfortable vision

Preventive protection against blue light

The properties of the uvex CBR65 and CBR23 lens technology are significantly different to those of uvex UV400. They filter high-energy visible light (HEV) – which causes particular strain on the retina in the range from 380 nm to 450 nm – by up to 50 or 95%.

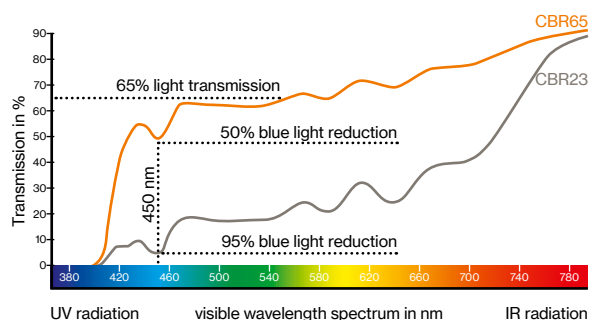

Strain on the eye caused by blue light has increased enormously as a result of intensive use of electronic devices (PCs, smartphones, tablets, LED TVs etc.) and the switch from incandescent light bulbs to LEDs. The short-term effects of this include eye strain, headaches and poor concentration, while in the long term there is an increased risk of age-related macular degeneration. uvex CBR65 and CBR23 reliably protect the eye against health risks without disrupting the body's internal clock.

Contrast

Contrast enhancement

Better contrast for clearer vision, helping to reduce strain on the eyes – even in diffused light.

Bluelight reduction

Blue light reduction

Blue light is reduced by up to 50 or 95%.

Relaxed vision

Relaxed vision

Ideal for high-concentration work; the eyes get less tired even when working for longer periods.

65% transmission

Slight tint

Ideal for use both indoors and outdoors. Ideal for working in bright LED lights, for example.

23% transmission

Optimal protection against glare

Especially for working outdoors.



9128064



9183064



9128223



9183223



9193064



9198064



9193223



9198223



9169164



9309064



9320223



For more information, visit uvex-safety.com/en/product-group/uvex-cbr65/

uvex



grip. fit. vented.

uvex pheos nxt

The uvex pheos nxt combines a classic sporty design with comfort, lightness and optimum protection.

The special design of the arms is not just visually impressive: the directional structure ensures extremely good grip – even for demanding work.

Numerous cut-outs in the side arms improve air circulation and make the spectacles lightweight without sacrificing strength.

In addition, the large panoramic lens offers a wide, distortion-free field of vision to provide a clear, comfortable view.

The uvex pheos nxt is an appealing all-rounder and ideal companion for a wide range of working conditions.

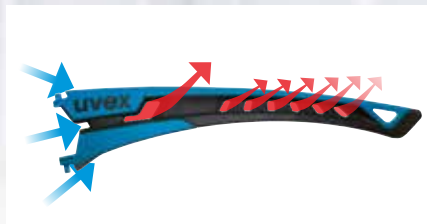

The innovative side arm design allows **maximum air circulation** for climate-optimised wearer comfort.



The **grip structure** guarantees a secure fit even during demanding work.



The proven **uvex supravision coating technology** (with UV400 protection) offers a distortion-free field of view at all times.



Lightweight design for an even more comfortable fit.



Safety Spectacles

uvex pheos nxt · uvex pheos nxt planet



9128265
9128415



9128295



9128376



9128064



9128223



9128280



uvex pheos nxt

- classic sporty, lightweight safety spectacle with innovative side arm structure for optimal, secure hold at all times
- ergonomically shaped side arms with grip structure and soft-grip temple ends provide a comfortable, secure fit without pressure
- numerous recesses in the side arms provide increased air circulation for excellent climate-optimised wearer comfort
- nose bridge designed for all-day comfort
- robust polycarbonate lens with uvex's proven supravision coating technology – permanent anti-fog and scratch-resistant lens
- UV400 – 100% protection against dangerous UV radiation up to 400 nm
- metal-free



For more information, visit uvex-safety.com/pheosnxt

uvex pheos nxt	uvex pheos nxt planet			
Art. no.	9128265	9128295	9128415	9128376
Version	uvex supravision excellence	uvex supravision excellence	uvex supravision ETC	uvex supravision extreme
Standard	EN 166, EN 170	EN 166, EN 170	EN 166, EN 170	EN 166, EN 170
Frame	blue, anthracite W 166 FT CE	anthracite, jade W 166 FT CE	blue, anthracite W 166 FT CE	lime, anthracite W 166 FT CE
Lens	PC clear UV400 2C-1,2 W1 FTKN CE	PC clear (mass balanced) UV400 2C-1,2 W1 FTKN CE	PC clear UV400 2C-1,2 W1 FTKN CE	PC clear UV400 2C-1,2 W1 FTKN CE
Weight	25 g	25 g	25 g	25 g
Order quantity multiples	10 PC	10 PC	10 PC	10 PC

uvex pheos nxt	uvex pheos nxt planet		
Art. no.	9128064	9128223	9128280
Version	uvex supravision excellence sunglare filter	uvex supravision excellence sunglare filter	uvex supravision excellence sunglare filter
Standard	EN 166, EN 172	EN 166, EN 172	EN 166, EN 172
Frame	white, black W 166 FT CE	white, black W 166 FT CE	lime, anthracite W 166 FT CE
Lens	PC CBR65 UV400 5-1,4 W1 FTKN CE	PC CBR23 UV400 5-2,5 W1 FTKN CE	PC grey 23% UV400 5-2,5 W1 FTKN CE
Weight	25 g	25 g	25 g
Order quantity multiples	10 PC	10 PC	10 PC

MADE IN GERMANY

uvex

sustainable. flexible. safe.



uvex i-guard

additional protection against liquids, particles and dirt thanks to the highly flexible frame that adapts to any face shape without pressure (marking 3 and 4 in accordance with EN 166)



uvex i-lite

impressive modern design with flat lens geometry



uvex i-guard+

goggles with headband go above and beyond the minimum requirements and boast increased mechanical strength

uvex i-range



reddot winner 2022

The uvex i-range is our new flexible 3in1 safety eyewear range that allows wearers to select the right product for the workplace hazard or environment.



x-tended sideshield
for additional side protection



Flat lens design
for an unrestricted field of vision



With proven **uvex supravision coating technology** and UV400 protection



protecting planet

by using recycled material //
by using bio-based material

Made of recycled and bio-based materials to conserve resources and protect the environment



Ergonomically shaped side arms
for a perfect fit and secure hold without creating pressure points



Three-stage adjustable side arms
for individual customisation



Soft and flexible face seal made from sustainable materials for a universal fit



uvex i-guard+ kit can be specifically adjusted to any application thanks to the flexibility to swap the side arms and headband

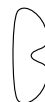

uvex i-range planet
sustainably manufactured models
made from recycled, bio-based
material

Safety Spectacles

uvex i-range · uvex i-range planet



uvex i-range

- versatile 3in1 safety eyewear range – allows eyewear to be adapted according to workplace hazards
- large, flat lens delivers unrestricted field of vision
- x-tended sideshield offers additional protection from hazards
- side arms with multi-incline points allow for a high level of individualisation to ensure a good fit for all facial shapes and head widths
- ergonomically shaped side arms provide a secure fit without pressure
- robust polycarbonate lens with uvex's proven supravision coating technology – permanent anti-fog and scratch-resistant lens

- UV400 – 100 % protection against dangerous UV radiation up to 400 nm
- nachhaltiger Vorteil: Scheiben und Kopfbänder können bei Bedarf ausgetauscht werden
- metal-free
- uvex i-guard: soft, flexible face seal adapts to the wearer providing both protection and comfort. It also protects against droplets or splashes of liquids and large dust particles (markings 3 and 4)
- uvex i-guard+: above features together with increased impact protection
- uvex i-guard+ kit: interchangeable side arms and headband means eyewear can be worn as either a spectacle or goggle depending on the workplace hazards



reddot winner 2022



For more information, visit
uvex-safety.com/en/irange

uvex i-range	uvex i-lite	uvex i-lite planet	uvex i-lite	uvex i-guard	uvex i-guard planet	uvex i-guard
Art. no.	9143265	9143295	9143281	9143266	9143296	9143376
Replacement lens	9143255	-	-	9143255	-	-
Version	uvex supravision excellence	uvex supravision excellence	uvex supravision excellence sunglare filter	uvex supravision excellence	uvex supravision excellence	uvex supravision extreme
Standard	EN 166, EN 170	EN 166, EN 170	EN 166, EN 172	EN 166, EN 170	EN 166, EN 170	EN 166, EN 170
Frame	anthracite, blue	anthracite, jade	anthracite, lime	anthracite, blue	anthracite, jade	anthracite, blue
	W 166 F CE	W 166 F CE	W 166 F CE	W 166 34 F CE	W 166 34 F CE	W 166 34 F CE
Lens	PC clear	PC clear (mass balanced)	PC grey 23%	PC clear	PC clear (mass balanced)	PC clear
	UV400	UV400	UV400	UV400	UV400	UV400
	2C-1.2 W1 FKN CE	2C-1.2 W1 FKN CE	5-2.5 W1 FKN CE	2C-1.2 W1 FKN CE	2C-1.2 W1 FKN CE	2C-1.2 W1 FKN CE
Weight	32 g	32 g	32 g	48 g	48 g	48 g
Order quantity multiples	10 PC	10 PC	10 PC	8 PC	8 PC	8 PC

uvex i-range	uvex i-guard	uvex i-guard+	uvex i-guard+ planet	uvex i-guard+	uvex i-guard+	uvex i-guard+ kit
Art. no.	9143282	9143267	9143297	9143377	9143283	9143300
Replacement lens	-	9143255	-	-	-	9143255
Replacement headband	uvex supravision excellence sunglare filter	9143011	9143013	9143011	-	9143011
Version	uvex supravision excellence	uvex supravision excellence	uvex supravision excellence	uvex supravision extreme	uvex supravision excellence sunglare filter	uvex supravision excellence
Standard	EN 166, EN 172	EN 166, EN 170	EN 166, EN 170	EN 166, EN 170	EN 166, EN 172	EN 166, EN 170
Frame	anthracite, lime	anthracite, blue	anthracite, jade	anthracite, blue	anthracite, lime	anthracite, blue
	W 166 34 F CE	W 166 34 B CE	W 166 34 B CE	W 166 34 B CE	W 166 34 B CE	W 166 34 B CE
Lens	PC grey 23%	PC clear	PC clear (mass balanced)	PC clear	PC grey 23%	PC clear
	UV400	UV400	UV400	UV400	UV400	UV400
	5-2.5 W1 FKN CE	2C-1.2 W1 BKN CE	2C-1.2 W1 BKN CE	2C-1.2 W1 BKN CE	5-2.5 W1 BKN CE	2C-1.2 W1 BKN CE
Weight	48 g	50 g	50 g	50 g	50 g	56 g
Order quantity multiples	8 PC	8 PC	8 PC	8 PC	8 PC	8 PC

MADE IN GERMANY

uvex

stylish. safe. sustainable.

Designed to recycle

Thanks to an innovative new production technology, the uvex pure-fit can be manufactured fully automatically from just one material without the need for additional assembly.

It is made entirely of polycarbonate and is therefore 100% recyclable – just like the product packaging.

This makes the uvex pure-fit an extremely sustainable solution.

Not just innovative but comfortable too:

These safety spectacles are extremely lightweight. The flexible side arms fit perfectly to any head shape and ensure a secure hold.

The uvex pure-fit is available in two different versions: uncoated and, of course, coated with the proven uvex supravision coating technology.



uvex pure-fit



Frameless and innovative lens design for an optimum, unrestricted field of vision



Flexible side arms for a perfect fit and secure hold without creating pressure points

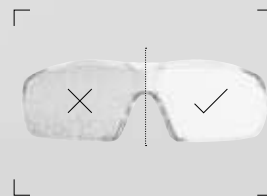

With proven uvex supravision coating technology or uncoated – but always with UV400 protection



Safety Spectacles

uvex pure-fit



scan for QR-Code
for further information.
uvex-safety.com/en/purefit

x-tended sideshield
for additional side protection



reduced to the max – pure, ultra-light-weight safety eyewear made of polycarbonate, weighing only 19 grams



100% recyclable



9145014



9145265

uvex pure-fit



- reduced to the max - pure, ultralight safety spectacle with innovative side arm concept weighing only 19 grams
- frameless lens design for a wide field of vision
- x-tended sideshield offers additional protection from hazards
- flexible side arms deliver the perfect secure, pressure-free fit
- nose bridge designed for all-day comfort
- robust polycarbonate lens with uvex's proven supravision coating technology – permanent anti-fog and scratch-resistant lens
- UV400 – 100% protection against dangerous UV radiation up to 400 nm
- metal-free

uvex pure-fit		
Art. no.	9145014	9145265
Version	uncoated	uvex supravision excellence
Standard	EN 166, EN 170	EN 166, EN 170
Frame	transparent	transparent
	W 166 FT CE	W 166 FT CE
Lens	PC clear	PC clear
	UV400	UV400
	2C-1.2 W1 FT CE	2C-1.2 W1 FTKN CE
Weight	19 g	19 g
Order quantity multiples	75 PC	75 PC



protecting planet

by creating
recyclable products

MADE IN GERMANY

uvex

strong.
sporty.
functional.



uvex su**XX**eed
upgraded
comfort

eXXtremely cool look
dynamic, attractive
frame design

maXXimum comfort
ergonomically shaped side arms and
soft grip temple ends – now even
more comfortable to wear, while still
providing a secure hold



fleXXible nose pad
for a non-slip and
pressure-free fit

eXXcellent vision
with proven uvex supravision
coating technology and UV400
protection

uvex su**XX**eed

eXXtra protection
against particles, dirt and
dust is provided by the
optional clip-in frame



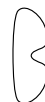

Safety Spectacles

uvex suXxeed · uvex suXxeed guard



9181415
9181265



9181268



9181180



9181365



9181281



9181288



9181880



Accessories: 9181001
Clip-in frame for uvex suXxeed

scan for QR-Code
for further information
uvex-safety.com/en/suxxeed-eyewear

uvex suXxeed

- sporty safety spectacle in an appealing, dynamic design
- ergonomically shaped side arms with soft-grip temple ends provide a comfortable, secure fit without pressure
- soft, flexible nose pad adapts to the wearer, delivering a non-slip and pressure-free fit
- UV400 – 100% protection against dangerous UV radiation up to 400 nm

- robust polycarbonate lens with uvex's proven supravision coating technology – permanent anti-fog and scratch-resistant lens
- optional clip-in frame seal provides extra protection against particles, dirt and dust
- a sustainable benefit: lenses can be replaced when required
- metal-free



uvex suXxeed	uvex suXxeed			uvex suXxeed guard	
Art. no.	9181265	9181268	9181415	9181180	9181365
Replacement lens	9181255	9181255	-	9181255	-
Version	uvex supravision excellence			uvex supravision excellence	uvex supravision excellence
Standard Frame	EN 166, EN 170 anthracite, blue W 166 FT CE	EN 166, EN 170 black, light grey W 166 FT CE	EN 166, EN 170 anthracite, blue W 166 FT CE	EN 166, EN 170 anthracite, blue W 166 FT CE	EN 166, EN 170 black, light grey W 166 FT CE
Lens	PC clear UV400 2C-1.2 W1 FTKN CE	PC clear UV400 2C-1.2 W1 FTKN CE	PC clear UV400 2C-1.2 W1 FTKN CE	PC clear UV400 2C-1.2 W1 FTKN CE	PC amber UV400 2C-1.2 W1 FTKN CE
Weight	28 g	28 g	28 g	33 g	28 g
Order quantity multiples	10 PC	10 PC	10 PC	10 PC	10 PC

uvex suXxeed	uvex suXxeed			clip-in frame
Art. no.	9181281	9181288	9181880	9181001
Version	uvex supravision excellence sunglare filter	uvex supravision excellence sunglare filter	uvex supravision variomatic self-tinting lenses	clip-in frame for uvex suXxeed
Standard Frame	EN 166, EN 172 anthracite, lime W 166 FT CE	EN 166, EN 172 black, light grey W 166 FT CE	EN 166, EN 170 black, light grey W 166 FT CE	black
Lens	PC grey 23% UV400 5-2.5 W1 FTKN CE	PC grey 23% UV400 5-2.5 W1 FTKN CE	PC light green UV400 2-1.2 W1 FTKN CE	
Weight	28 g	28 g	28 g	5 g
Order quantity multiples	10 PC	10 PC	10 PC	20 PC

MADE IN GERMANY

uvex fitting guide

Useful tips for making sure that your uvex safety eyewear fits perfectly

Wearing just any safety eyewear is not enough to protect your eyes. If your safety eyewear fits poorly or incorrectly, you're putting yourself at a higher risk of injury. Head and face shapes vary considerably, so it's impossible to find one pair that works for everyone. When trying on new safety eyewear, use this guide and review the eyewear description and materials.

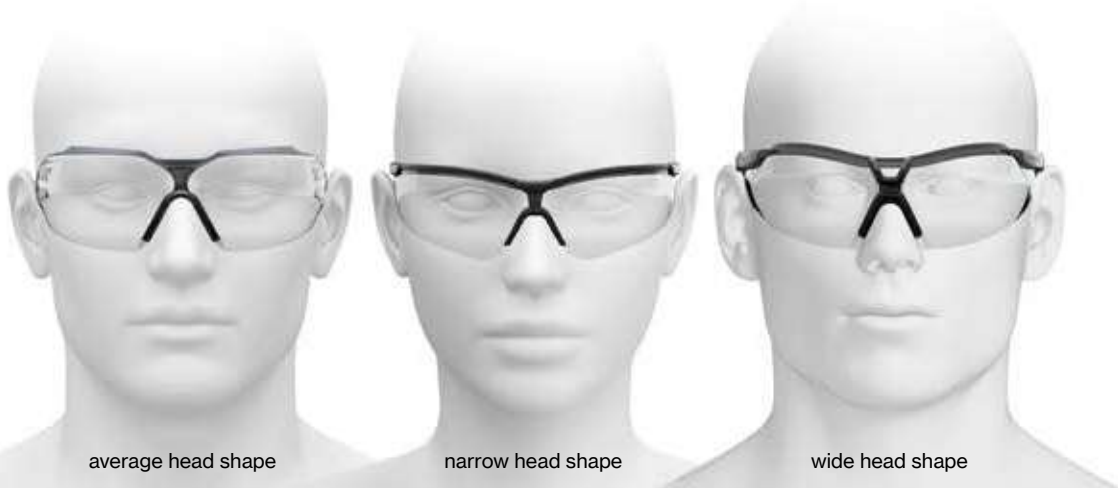

Selecting the right model

Pay attention to:

- excellent fit and eye coverage
- offers a good field of vision
- adjustable to improve fit



Choose the model that best suits you and your work. The shape and fit of the eyewear have an impact on the view, the protection and the wearer comfort.

Checklist

- 1 No uncomfortable pressure points on the side of the head or behind the ears.
- 2 The nose pad is comfortable and lies on your nose without pinching.
- 3 You should be able to see in all directions without your vision being obstructed.
- 4 The overall weight of the safety eyewear is distributed evenly.
- 5 The eyewear fits close to your face without touching your eyelashes. The gap between the eyewear and your face should not exceed 6 to 8 mm.
- 6 The eyewear stays in place when you move your head forwards or backwards and tilt your head side to side.



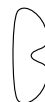

Safety Spectacles

uvex i-5 · uvex i-5 guard



9183065
9183415
9183265



9183180



9183064



9183223



9183281



Further information can be found at
uvex-safety.com/en/i5
(or scan the QR code).



Accessories: 9183001
Clip-in frame for uvex i-5

uvex i-5

- sporty premium quality safety spectacle with a range of adaptive features
- x-tended eyeshield: soft seal frame technology wraps around the brow providing protection from particle ingress
- x-tended sideshield offers additional protection from hazards
- ergonomically shaped side arms with multi-incline points and length adjustment allow for a high level of individualisation to ensure a good fit for all facial shapes and head widths

- soft-grip temple ends provide a comfortable, secure fit without pressure
- soft, flexible nose pad adapts to the wearer, delivering a non-slip and pressure-free fit
- robust polycarbonate lens with uvex's proven supravision coating technology – permanent anti-fog and scratch-resistant lens
- UV400 – 100% protection against dangerous UV radiation up to 400 nm
- optional clip-in frame seal provides extra protection against particles, dirt and dust
- metal-free



reddot winner 2020



uvex i-5	9183065	9183265	9183415	uvex i-5 guard
Art. no.	9183065	9183265	9183415	9183180
Version	uvex supravision sapphire	uvex supravision excellence	uvex supravision ETC	uvex supravision excellence incl. clip-in frame
Standard Frame	EN 166, EN 170 anthracite, blue W 166 FT CE	EN 166, EN 170 anthracite, blue W 166 FT CE	EN 166, EN 170 anthracite, blue W 166 FT CE	EN 166, EN 170 anthracite, blue W 166 FT CE
Lens	PC clear UV400 2C-1.2 W1 FTK CE	PC clear UV400 2C-1.2 W1 FTKN CE	PC clear UV400 2C-1.2 W1 FTKN CE	PC clear UV400 2C-1.2 W1 FTKN CE
Weight	29 g	29 g	29 g	35 g
Order quantity multiples	10 PC	10 PC	10 PC	10 PC

uvex i-5	9183064	9183223	9183281	clip-in frame
Art. no.	9183064	9183223	9183281	9183001
Version	uvex supravision excellence sunglare filter	uvex supravision excellence sunglare filter	uvex supravision excellence sunglare filter	clip-in frame for uvex i-5
Standard Frame	EN 166, EN 172 white, black W 166 FT CE	EN 166, EN 172 white, black W 166 FT CE	EN 166, EN 172 anthracite, lime W 166 FT CE	anthracite
Lens	PC CBR65 UV400 5-1.4 W1 FTKN CE	PC CBR23 UV400 5-2.5 W1 FTKN CE	PC grey 23% UV400 5-2.5 W1 FTKN CE	
Weight	29 g	29 g	29 g	6 g
Order quantity multiples	10 PC	10 PC	10 PC	20 PC

MADE IN GERMANY

Safety Spectacles

uvex x-fit pro · uvex x-fit pro guard



9199247



9199245



9199680



9199277

uvex x-fit pro

- functional, modular safety spectacle with a wide range of accessories
- ergonomically shaped side arms with soft-grip temple ends provide a comfortable, secure fit without pressure
- adjustment for every head and facial shape with the uvex Comfort Slider – a multi-stage temple inclination that allows wearers to achieve their own comfortable wearing position
- modular system allows functional accessories to be attached enhancing the ability to get on with the job
- soft, flexible nose pad adapts to the wearer, delivering a non-slip and pressure-free fit
- robust polycarbonate lens with uvex's proven supravision coating technology – permanent anti-fog and scratch-resistant lens
- UV400 – 100% protection against dangerous UVA and UVB radiation up to 400 nm
- optional clip-in frame seal provides extra protection against particles, dirt and dust
- metal-free

uvex x-fit pro		uvex x-fit pro guard		
Art. no.	9199247	9199245	9199680	9199277
Version	uvex supravision excellence without sliders	uvex supravision excellence	uvex supravision excellence without sliders, incl. clip-in frame	uvex supravision excellence sunglare filter, without sliders
Standard	EN 166, EN 170	EN 166, EN 170	EN 166, EN 170	EN 166, EN 172
Frame	blue, anthracite W 166 FT CE	blue, anthracite W 166 FT CE	blue, anthracite W 166 FT CE	anthracite, light grey W 166 FT CE
Lens	PC clear UV400 2C-1.2 W1 FTKN CE	PC clear UV400 2C-1.2 W1 FTKN CE	PC clear UV400 2C-1.2 W1 FTKN CE	PC grey 23% UV400 5-2.5 W1 FTKN CE
Weight	24 g	28 g	30 g	24 g
Order quantity multiples	10 PC	10 PC	10 PC	10 PC

MADE IN GERMANY 

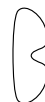

Safety Spectacles

uvex x-fit · uvex x-fit guard



9199285
9199085



9199265
9199415



9199180



9199286



9199280



Accessories: 9199001
Clip-in frame for uvex x-fit and uvex x-fit pro



Accessories: 9958023
Headband for uvex x-fit and uvex x-fit pro

uvex x-fit

- classic, close fitting safety spectacle with extension kit options
- frameless lens design for a wide field of vision
- adjustment for every head and facial shape with the optional uvex Comfort Slider - a multi-stage temple inclination that allows wearers to achieve their own comfortable wearing position
- modular system allows functional accessories to be attached enhancing the ability to get on with the job
- nose bridge designed for all-day comfort

- robust polycarbonate lens with uvex's proven supravision coating technology – permanent anti-fog and scratch-resistant lens
- UV400 – 100% protection against dangerous UVA and UVB radiation up to 400 nm
- optional clip-in frame seal provides extra protection against particles, dirt and dust
- metal-free

uvex x-fit				uvex x-fit guard			
Art. no.	9199085	9199285	9199265	9199415	9199180	9199286	9199280
Version	uvex supravision sapphire	uvex supravision excellence	uvex supravision excellence	uvex supravision ETC	uvex supravision excellence incl. clip-in frame	uvex supravision excellence contrast-enhancing	uvex supravision excellence sunglare filter
Standard Frame	EN 166, EN 170 grey translucent W 166 FT CE	EN 166, EN 170 grey translucent W 166 FT CE	EN 166, EN 170 blue translucent W 166 FT CE	EN 166, EN 170 blue translucent W 166 FT CE	EN 166, EN 170 grey translucent W 166 FT CE	EN 166, EN 170 grey translucent W 166 FT CE	EN 166, EN 172 grey translucent W 166 FT CE
Lens	PC clear UV400 2C-1.2 W1 FTK CE	PC clear UV400 2C-1.2 W1 FTKN CE	PC clear UV400 2C-1.2 W1 FTKN CE	PC clear UV400 2C-1.2 W1 FTKN CE	PC clear UV400 2C-1.2 W1 FTKN CE	PC amber UV400 2C-1.2 W1 FTKN CE	PC grey 23% UV400 5-2.5 W1 FTKN CE
Weight	23 g	23 g	23 g	23 g	23 g	23 g	23 g
Order quantity multiples	10 PC	10 PC	10 PC	10 PC	10 PC	10 PC	10 PC

Art. no.	clip-in frame	uvex x-fit pro Headband
Version	9199001	9958023
Colour	clip-in frame for uvex x-fit and uvex x-fit pro	for attaching on uvex x-fit and uvex x-fit pro, metal-free
Order unit/	black	black
Order quantity multiples	20 PC	10 PC

Safety Spectacles

uvex sportstyle · uvex sportstyle planet



uvex sportstyle

- sporty, lightweight safety spectacle with a contoured lens that will fit narrow and wider faces equally well
- the combination of soft padding around the brow with ergonomically shaped side arms and soft-grip temple ends provide a comfortable, secure fit without pressure
- soft, adjustable nose pad allows spectacle to be adapted to the wearer to deliver a comfortable, non-slip and pressure-free fit
- robust polycarbonate lens with uvex's proven supravision coating technology – permanent anti-fog and scratch-resistant lens
- UV400 – 100% protection against dangerous UV radiation up to 400 nm
- a sustainable benefit: lenses can be replaced when required

uvex sportstyle	uvex sportstyle planet		uvex sportstyle planet		uvex sportstyle planet	
Art. no.	9193080	9193265	9193295	9193415	9193376	9193395
Replacement lens	–	–	–	–	9193255	–
Version	uvex supravision plus oil & gas	uvex supravision excellence	uvex supravision excellence	uvex supravision ETC	uvex supravision extreme	uvex supravision extreme
Standard	EN 166, EN 170	EN 166, EN 170	EN 166, EN 170	EN 166, EN 170	EN 166, EN 170	EN 166, EN 170
Frame	black, grey W 166 FT CE	black, lime W 166 FT CE	beige, green W 166 FT CE	black, blue W 166 FT CE	black, petrol W 166 FT CE	anthracite, jade W 166 FT CE
Lens	PC clear UV400 2C-1.2 W1 FTKN CE	PC clear UV400 2C-1.2 W1 FTKN CE	PC clear (mass balanced) UV400 2C-1.2 W1 FTKN CE	PC clear UV400 2C-1.2 W1 FTKN CE	PC clear UV400 2C-1.2 W1 FTKN CE	PC clear (mass balanced) UV400 2C-1.2 W1 FTKN CE
Weight	23 g	23 g	23 g	23 g	23 g	23 g
Order quantity multiples	10 PC	10 PC	10 PC	10 PC	10 PC	10 ST

uvex sportstyle	uvex sportstyle planet		uvex sportstyle planet		uvex sportstyle planet	
Art. no.	9193838	9193064	9193223	9193280	9193888	9193880
Version	uvex supravision AR super anti-reflective lenses	uvex supravision extreme sunglare filter	uvex supravision extreme sunglare filter	uvex supravision extreme sunglare filter	anti-fog on the inside sunglare filter, silver mirror	uvex supravision variomatic self-tinting lenses
Standard	EN 166, EN 170	EN 166, EN 172	EN 166, EN 172	EN 166, EN 172	EN 166, EN 172	EN 166, EN 170
Frame	black, blue W 166 FT CE	white, black W 166 FT CE	white, black W 166 FT CE	white, black W 166 FT CE	white, black W 166 FT CE	black, anthracite W 166 FT CE
Lens	PC clear UV400 2C-1.2 W1 FT CE	PC CBR65 UV400 5-1.4 W1 FTKN CE	PC CBR23 UV400 5-2.5 W1 FTKN CE	PC grey 23% UV400 5-2.5 W1 FTKN CE	PC silver mirror, grey UV400 5-3.1 W1 FTN CE	PC light green UV400 2-1.2 W1 FTKN CE
Weight	23 g	23 g	23 g	23 g	23 g	23 g
Order quantity multiples	10 PC	10 PC	10 PC	10 PC	10 PC	PC

MADE IN GERMANY



Safety Spectacles

uvex pheos cx2



► Also available as safety goggles (see page 61)

uvex pheos cx2

- sporty looking safety spectacle with high wearer acceptance
- x-tended eyeshield: soft seal frame technology wraps around the brow providing protection from particle ingress
- ergonomically shaped side arms with soft-grip temple ends provide a comfortable, secure fit without pressure
- soft, flexible nose pad adapts to the wearer, delivering a non-slip and pressure-free fit

- robust polycarbonate lens with uvex's proven supravision coating technology – permanent anti-fog and scratch-resistant lens
- UV400 – 100% protection against dangerous UV radiation up to 400 nm
- metal-free



uvex pheos cx2							
Art.-Nr.	9198275	9198257	9198258	9198013	9198415	9198376	9198015
Version	uvex supravision sapphire	uvex supravision excellence	uvex supravision excellence	uvex supravision excellence	uvex supravision ETC	uvex supravision extreme	uvex supravision excellence contrast-enhancing
Standard Frame	EN 166, EN 170 blue, grey W 166 FT CE	EN 166, EN 170 blue, grey W 166 FT CE	EN 166, EN 170 red, grey W 166 FT CE	EN 166, EN 170 silver, black W 166 FT CE	EN 166, EN 170 anthracite, blue W 166 FT CE	EN 166, EN 170 silver, black W 166 FT CE	EN 166, EN 170 silver, black W 166 FT CE
Lens	PC clear UV400 2C-1.2 W1 FTK CE	PC clear UV400 2C-1.2 W1 FTKN CE	PC clear UV400 2C-1.2 W1 FTKN CE	PC clear UV400 2C-1.2 W1 FTKN CE	PC clear UV400 2C-1.2 W1 FTKN CE	PC clear UV400 2C-1.2 W1 FTKN CE	PC amber UV400 2C-1.2 W1 FTKN CE
Weight	28 g	28 g	28 g	28 g	28 g	28 g	28 g
Order quantity multiples	10 PC	10 PC	10 PC	10 PC	10 PC	10 PC	10 PC

uvex pheos cx2						
Art. no.	9198064	9198223	9198237	9198014	9198230	9198888
Version	uvex supravision excellence sunglare filter	uvex supravision excellence sunglare filter	uvex supravision excellence sunglare filter	uvex supravision excellence sunglare filter	uvex supravision excellence sunglare filter	anti-fog on the inside sunglare filter, silver mirror
Standard Frame	EN 166, EN 172 white, black W 166 FT CE	EN 166, EN 172 white, black W 166 FT CE	EN 166, EN 172 white, black W 166 FT CE	EN 166, EN 172 silver, black W 166 FT CE	EN 166, EN 172 white, black W 166 FT CE	EN 166, EN 172 silver, black W 166 FT CE
Lens	PC CBR65 UV400 5-1.4 W1 FTKN CE	PC CBR23 UV400 5-2.5 W1 FTKN CE	PC grey 23% UV400 5-2.5 W1 FTKN CE	PC grey 23% UV400 5-2.5 W1 FTKN CE	PC grey 12% UV400 5-3.1 W1 FTKN CE	PC silver mirror, grey UV400 5-3.1 W1 FTN CE
Weight	28 g	28 g	28 g	28 g	28 g	28 g
Order quantity multiples	10 PC	10 PC	10 PC	10 PC	10 PC	10 PC

MADE IN GERMANY

Safety Spectacles

uvex pheos · uvex pheos guard



uvex pheos

- sporty, timeless safety spectacle; frameless design allowing for an extra-large field of vision
- ergonomically shaped side arms with soft-grip temple ends provide a comfortable, secure fit without pressure
- nose bridge designed for all-day comfort
- robust polycarbonate lens with uvex's proven supravision coating technology – permanent anti-fog and scratch-resistant lens
- UV400 – 100% protection against dangerous UV radiation up to 400 nm
- optional clip-in frame seal provides extra protection against particles, dirt and dust
- headband option holds eyewear in place during overhead or work in confined spaces
- available as standard size or narrow version
- fits the uvex IES
- metal-free

uvex pheos				uvex pheos CB		
Art. no.	9192080	9192225	9192215	9192485	9192415	9192280
Version	uvex supravision plus standard size, oil & gas	uvex supravision excellence standard size	uvex supravision excellence standard size	uvex supravision excellence standard size	uvex supravision ETC standard size	uvex supravision extreme standard size
Standard	EN 166, EN 170	EN 166, EN 170	EN 166, EN 170	EN 166, EN 170	EN 166, EN 170	EN 166, EN 170
Frame	black, grey	black, green	light grey, grey	black, grey	anthracite, blue	black, grey
Lens	W 166 FT CE PC clear UV400 2C-1.2 W1 FTKN CE	W 166 FT CE PC clear UV400 2C-1.2 W1 FTKN CE	W 166 FT CE PC clear UV400 2C-1.2 W1 FTKN CE	W 166 FT CE PC clear UV400 2C-1.2 W1 FTKN CE	W 166 FT CE PC farblos UV400 2C-1.2 W1 FTKN CE	W 166 FT CE PC clear UV400 2C-1.2 W1 FTKN CE
Weight	29 g	29 g	29 g	30 g	29 g	29 g
Order quantity multiples	10 PC	10 PC	10 PC	10 PC	10 PC	10 PC

uvex pheos					uvex pheos guard
Art. no.	9192385	9192285	9192281	9192881	9192180
Version	uvex supravision excellence standard size, contrast-enhancing	uvex supravision excellence standard size, sunglare filter	uvex supravision extreme standard size, sunglare filter	anti-fog on the inside standard size, sunglare filter, silver mirror	uvex supravision extreme standard size incl. clip-in frame and headband
Standard	EN 166, EN 170	EN 166, EN 172	EN 166, EN 172	EN 166, EN 172	EN 166, EN 170
Frame	black, yellow	black, grey	black, grey	light grey, grey	black, grey
Lens	W 166 FT CE PC amber UV400 2C-1.2 W1 FTKN CE	W 166 FT CE PC grey 23% UV400 5-2.5 W1 FTKN CE	W 166 FT CE PC grey 23% UV400 5-2.5 W1 FTKN CE	W 166 FT CE PC silver mirror grey UV400 5-1.7 W1 FTN CE	W 166 FT CE PC clear UV400 2C-1.2 W1 FTKN CE
Weight	29 g	29 g	29 g	29 g	46 g
Order quantity multiples	10 PC	10 PC	10 PC	10 PC	10 PC

MADE IN GERMANY

Safety Spectacles

uvex pheos s · uvex pheos s guard



9192725

9192785
9192282

9192283



9192680



Accessories: 9192001 / 9192002
Clip-in frame uvex pheos / uvex pheos s



Accessories: 9958020
Headband uvex pheos / uvex pheos s

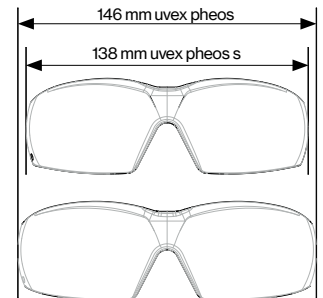

	uvex pheos s			uvex pheos s guard	
Art. no.	9192725	9192785	9192282	9192283	9192680
Version	uvex supravision excellence narrow version	uvex supravision excellence narrow version	uvex supravision extreme narrow version	uvex supravision extreme narrow version, sunglare filter	uvex supravision extreme narrow version incl. clip-in frame and headband
Standard Frame	EN 166, EN 170 white, green W 166 FT CE	EN 166, EN 170 anthracite, grey W 166 FT CE	EN 166, EN 170 anthracite, grey W 166 FT CE	EN 166, EN 172 anthracite, grey W 166 FT CE	EN 166, EN 170 anthracite, grey W 166 FT CE
Lens	PC clear UV400 2C-1.2 W1 FTKN CE	PC clear UV400 2C-1.2 W1 FTKN CE	PC clear UV400 2C-1.2 W1 FTKN CE	PC grey 23% UV400 5-2.5 W1 FTKN CE	PC clear UV400 2C-1.2 W1 FTKN CE
Weight	28 g	28 g	28 g	28 g	45 g
Order quantity multiples	10 PC	10 PC	10 PC	10 PC	10 PC

Accessories

	9192001	9192002	9958020
Art. no.	9192001	9192002	9958020
Version	clip-in frame for uvex pheos standard size	clip-in frame for uvex pheos s narrow version	headband for uvex pheos and uvex pheos s
Colour	black	black	grey, black
Order quantity multiples	20 PC	20 PC	10 PC

MADE IN GERMANY 

Safety Spectacles

uvex i-3 · uvex i-3 guard



9190270
9190275



9190280
9190175



9190180



9190839
9190838



9190281



9190885



9190880

uvex i-3

- adjustable, multi-feature premium quality safety spectacle
- the combination of soft padding around the brow with ergonomically shaped side arms and soft-grip temple ends provide a comfortable, secure fit without pressure
- side arms with multi-incline points allow for a high level of individualisation to ensure a good fit for all facial shapes and head widths
- soft, adjustable nose pad allows spectacle to be adapted to the wearer to deliver a comfortable, non-slip and pressure-free fit

- robust polycarbonate lens with uvex's proven supravision coating technology – permanent anti-fog and scratch-resistant lens
- UV400 – 100% protection against dangerous UV radiation up to 400 nm
- optional clip-in frame seal provides extra protection against particles, dirt and dust
- available as standard size or narrow version
- a sustainable benefit: lenses can be replaced when required
- metal-free

uvex i-3	9190270	9190175	9190275	9190280	uvex i-3 guard
Art. no.	9190270	9190175	9190275	9190280	9190180
Replacement lens	–	–	9190258	9190258	9190258
Version	uvex supravision sapphire standard size	uvex supravision plus standard size oil & gas	uvex supravision excellence standard size	uvex supravision excellence standard size	uvex supravision excellence standard size incl. clip-in frame
Standard Frame	EN 166, EN 170 anthracite, blue	EN 166, EN 170 black, light grey	EN 166, EN 170 anthracite, blue	EN 166, EN 170 black, light grey	EN 166, EN 170 anthracite, blue
Lens	W 166 FT CE PC clear UV400 2C-1.2 W1 FTK CE	W 166 FT CE PC clear UV400 2C-1.2 W1 FTKN CE	W 166 FT CE PC clear UV400 2C-1.2 W1 FTKN CE	W 166 FT CE PC clear UV400 2C-1.2 W1 FTKN CE	W 166 FT CE PC clear UV400 2C-1.2 W1 FTKN CE
Weight	30 g	30 g	30 g	30 g	36 g
Order quantity multiples	10 PC	10 PC	10 PC	10 PC	10 PC

uvex i-3	9190839	9190838	9190281	9190885	9190880
Art. no.	9190839	9190838	9190281	9190885	9190880
Version	uvex supravision AR standard size super anti-reflective lenses	uvex supravision AR standard size super anti-reflective lenses	uvex supravision excellence standard size sunglare filter	anti-fog on the inside standard size sunglare filter, silver mirror	uvex supravision variomatic standard size self-tinting lenses
Standard Frame	EN 166, EN 170 black, blue	EN 166, EN 170 black, blue	EN 166, EN 172 black, light grey	EN 166, EN 172 black, light grey	EN 166, EN 170 black, anthracite
Lens	W 166 FT CE PC clear UV400 2C-1.2 W1 FT CE	W 166 FT CE PC clear UV400 2C-1.2 W1 FT CE	W 166 FT CE PC grey 23% UV400 5-2.5 W1 FTKN CE	W 166 FT CE PC silver mirror grey UV400 5-3.1 W1 FTN CE	W 166 FT CE PC light green UV400 2-1.2 W1 FTKN CE
Weight	30 g	30 g	30 g	30 g	30 g
Order quantity multiples/ Order unit	10 PC	PC	10 PC	10 PC	PC

MADE IN GERMANY

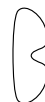

Safety Spectacles

uvex i-3 s · uvex i-3 s guard



9190265



9190680



9190085



9190288



Accessories: 9190001
Clip-in frame for uvex i-3 and uvex i-3 s

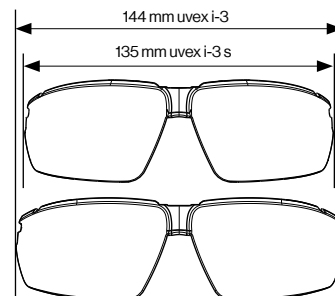

uvex i-3 s	9190265	uvex i-3 s guard	9190680	9190085	9190288	Accessories
Art. no.	9190265	9190680	9190680	9190085	9190288	9190001
Replacement lens	9190257	9190257	-	-	-	-
Version	uvex supravision excellence narrow version	uvex supravision excellence narrow version incl. clip-in frame	uvex supravision excellence narrow version contrast-enhancing	uvex supravision excellence narrow version sunglare filter	uvex supravision excellence narrow version sunglare filter	clip-in frame for uvex i-3 and uvex i-3 s
Standard Frame	EN 166, EN 170 anthracite, lime	EN 166, EN 170 anthracite, blue	EN 166, EN 170 anthracite, yellow	EN 166, EN 170 anthracite, lime	EN 166, EN 170 anthracite, lime	black
Lens	W 166 FT CE PC clear UV400 2C-1.2 W1 FTKN CE	W 166 FT CE PC clear UV400 2C-1.2 W1 FTKN CE	W 166 FT CE PC amber UV400 2C-1.2 W1 FTKN CE	W 166 FT CE PC grey 23 % UV400 5-2.5 W1 FTKN CE	W 166 FT CE PC grey 23 % UV400 5-2.5 W1 FTKN CE	
Weight	29 g	35 g	29 g	29 g	29 g	6 g
Order quantity multiples	10 PC	10 PC	10 PC	10 PC	10 PC	20 PC

uvex safety eyewear

Also ideal for narrow faces

The geometries of our spectacles are as different as the faces of the people who wear them. The products in this range can be worn by anyone, but are particularly suitable for people with narrow faces.

Their optimal fit and the fact that they can be adjusted mean that these safety spectacles fit different head shapes perfectly, providing the wearer with the best possible protection from particles, sparks or dust.

uvex has a range of safety eyewear
to meet every need —
including those
with narrower faces.

uvex
spectacles:



uvex pheos nxt 9128



uvex x-fit 9199



uvex sportstyle 9193



uvex pheos cx2 9198



uvex pheos s 9192



uvex i-3 s 9190



uvex i-works 9194

uvex
guard
version:



uvex pheos s guard 9192

uvex
goggles:



uvex i-guard+ 9143



uvex pheos cx2 sonic 9309



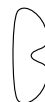

Safety Spectacles

uvex i-works



9194171



9194265



9194365



9194270



9194885

uvex i-works

- sporty, robust safety spectacle, available in a range of lens shades
- ergonomically shaped side arms with soft-grip temple ends provide a comfortable, secure fit without pressure
- nose bridge designed for all-day comfort
- robust polycarbonate lens with uvex's proven supravision coating technology – permanent anti-fog and scratch-resistant lens

- UV400 – 100% protection against dangerous UV radiation up to 400 nm
- fits the uvex IES
- a sustainable benefit: lenses can be replaced when required
- metal-free

uvex i-works					
Art. no.	9194171	9194265	9194365	9194270	9194885
Replacement lens	9194255	9194255	-	-	-
Version	uvex supravision excellence	uvex supravision excellence	uvex supravision excellence contrast-enhancing	uvex supravision excellence sunglare filter	anti-fog on the inside silver mirror
Standard	EN 166, EN 170	EN 166, EN 170	EN 166, EN 170	EN 166, EN 172	EN 166, EN 172
Frame	anthracite, blue W 166 FT CE	anthracite, lime W 166 FT CE	black, yellow W 166 FT CE	anthracite, grey W 166 FT CE	anthracite, grey W 166 FT CE
Lens	PC clear UV400 2C-1.2 W1 FTKN CE	PC clear UV400 2C-1.2 W1 FTKN CE	PC amber UV400 2C-1.2 W1 FTKN CE	PC grey 23% UV400 5-2.5 W1 FTKN CE	PC silver mirror grey UV400 5-1.7 W1 FTN CE
Weight	26 g	26 g	26 g	26 g	26 g
Order quantity multiples	10 PC	10 ST	10 PC	10 PC	10 PC

MADE IN GERMANY

Safety eyewear – matching your corporate identity

Eye protection with “personality”

Give your team an unmistakable image: uvex safety eyewear offer various options for individual design – from printing your company’s logo on the side arms to frames in your company’s colours. You can coordinate your protective equipment perfectly with your corporate identity.

Frames in the company colours

“Your” safety spectacles are recognisable at first glance: the frames are designed in your company colours.

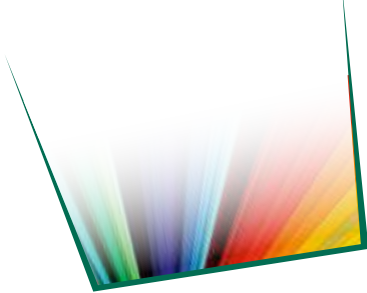

Insert in the side arms

Adding your company name to the soft components of the side arms is both bespoke and subtle.

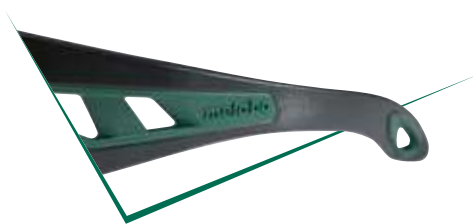

Pad printing on the side arms (1 to 4 colours)

The direct pad printing process is recommended for printing your logo in colour on the side arms.



How individual can you be?

We are happy to advise you personally on the technical options for customising our safety eyewear.

Please note that the following minimum quantities must be ordered:

Pad printing – minimum of 500 pairs

A combination of either lens and/or frame, with and without pad printing - minimum of 2,500 pairs.

Insert/customised corporate colouring/individual headband/

laser engraving – minimum of 5,000 pairs

Customised accessories available on request

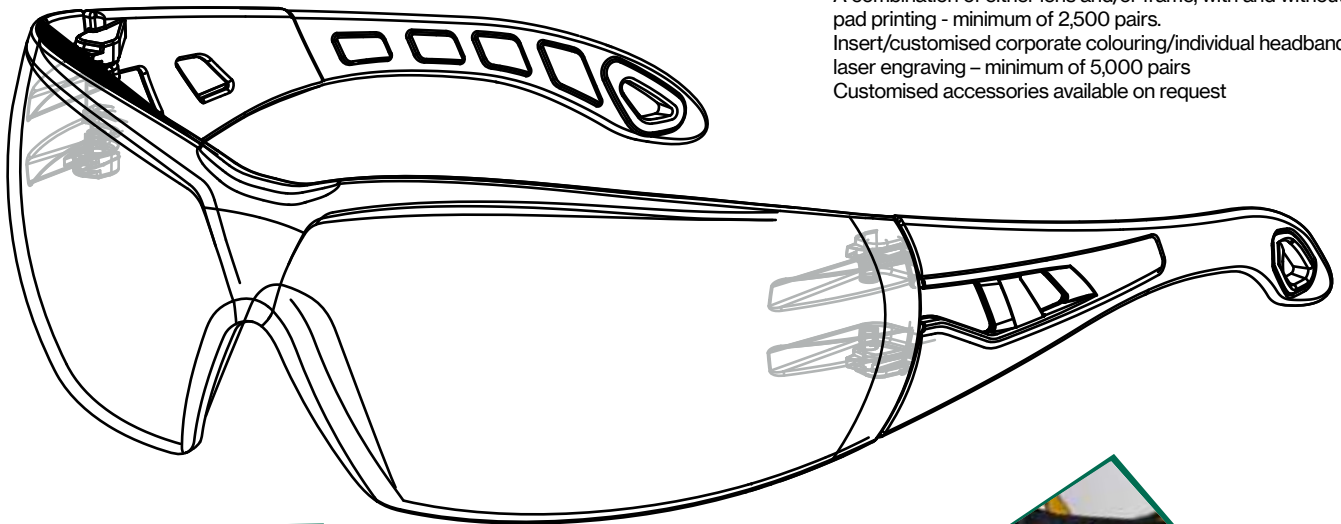

Customised accessories

Have your logo printed on your spectacle case.



Laser engraving on the lens

Safety spectacles will retain 100% of their functionality even with customised laser engraving.



Headband embroidery

Customise your goggles by having your corporate logo embroidered on the headband.





Safety Spectacles

uvex astrospec 2.0



9164065



9164187



9164285



9164275



9164246



Accessories: 6109200
RX insert for uvex astrospec 2.0

uvex astrospec 2.0

- classic safety spectacle with flat lens for a wide field of vision
- ergonomically shaped side arms with multi-incline points allow for a high level of individualisation to ensure a good fit for all facial shapes and head widths
- side arms with soft-grip temple ends provide a comfortable, secure fit without pressure
- nose bridge designed for all-day comfort
- robust polycarbonate lens with uvex's proven supravision coating technology – permanent anti-fog and scratch-resistant lens
- UV400 – 100% protection against dangerous UV radiation up to 400 nm

uvex astrospec 2.0						Accessories
Art. no.	9164065	9164187	9164285	9164275	9164246	6109200
Version	uvex supravision sapphire	uvex supravision plus oil & gas	uvex supravision excellence	uvex supravision extreme	uvex supravision excellence sunglare filter	RX insert for uvex astrospec 2.0
Standard	EN 166, EN 170	EN 166, EN 170	EN 166, EN 170	EN 166, EN 170	EN 166, EN 172	
Frame	blue, light blue	black, grey	black, lime	anthracite, petrol	neon orange, black	clear
	W 166 FT CE	W 166 FT CE	W 166 FT CE	W 166 FT CE	W 166 FT CE	
Lens	PC clear	PC clear	PC clear	PC clear	PC grey 23%	
	UV400	UV400	UV400	UV400	UV400	
	2C-1.2 W1 FTKN CE	2C-1.2 W1 FTKN CE	2C-1.2 W1 FTKN CE	2C-1.2 W1 FTKN CE	5-2.5 W1 FTKN CE	
Weight	42 g	42 g	42 g	42 g	42 g	6g
Order quantity multiples/	10 PC	10 PC	10 PC	10 PC	10 PC	PC
Order unit						

MADE IN GERMANY

Safety Spectacles

uvex super g



9172085



9172110
9172210



9172265



9172281

uvex super g

- sporty, extremely lightweight safety spectacle with innovative temple concept for high levels of comfort
- flexible side arms with soft-grip temple ends provide a comfortable, secure fit without pressure
- soft, flexible nose pad for a non-slip and pressure-free fit

- robust polycarbonate lens with uvex's proven supravision coating technology – permanent anti-fog and scratch-resistant lens
- UV400 – 100% protection against dangerous UV radiation up to 400 nm
- a sustainable benefit: lenses can be replaced when required
- metal-free

uvex super g	9172085	9172110	9172210	9172265	9172281
Art. no.	9172085	9172110	9172210	9172265	9172281
Replacement lens	–	–	9172255	9172255	–
Version	uvex supravision sapphire	uvex supravision plus	uvex supravision excellence	uvex supravision excellence	uvex supravision excellence sunglare filter
Standard	EN 166, EN 170	EN 166, EN 170	EN 166, EN 170	EN 166, EN 170	EN 166, EN 172
Frame	grey metallic, black W 166 FT CE	clear, grey W 166 FT CE	clear, grey W 166 FT CE	navy blue, white W 166 FT CE	anthracite, lime W 166 FT CE
Lens	PC clear UV400 2C-1.2 W1 FTK CE	PC clear UV400 2C-1.2 W1 FTKN CE	PC clear UV400 2C-1.2 W1 FTKN CE	PC clear UV400 2C-1.2 W1 FTKN CE	PC grey 23% UV400 5-2.5 W1 FTKN CE
Weight	18 g	18 g	18 g	18 g	18 g
Order quantity multiples	10 PC	10 PC	10 PC	10 PC	10 PC

MADE IN GERMANY 

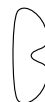

Safety Spectacles

uvex super fit



9178065
9178265



9178185



9178315



9178415



9178286

uvex super fit

- sporty safety spectacle with slim, flat side arms, making it highly compatible with other PPE
- the combination of soft padding around the brow with ergonomically shaped side arms and soft-grip temple ends provide a comfortable, secure fit without pressure
- soft, adjustable nose pad allows spectacle to be adapted to the wearer to deliver a comfortable, non-slip and pressure-free fit
- robust polycarbonate lens with uvex's proven supravision coating technology – permanent anti-fog and scratch-resistant lens
- UV400 – 100% protection against dangerous UV radiation up to 400 nm
- a sustainable benefit: lenses can be replaced when required

uvex super fit						
Art. no.	9178065	9178185	9178265	9178315	9178415	9178286
Replacement lens	-	-	9172255	9172255	-	-
Version	uvex supravision sapphire	uvex supravision plus	uvex supravision excellence	uvex supravision excellence	uvex supravision ETC	uvex supravision excellence sunglare filter
Standard	EN 166, EN 170	EN 166, EN 170	EN 166, EN 170	EN 166, EN 170	EN 166, EN 170	EN 166, EN 172
Frame	navy blue, white W 166 FT CE	black, white W 166 FT CE	navy blue, white W 166 FT CE	white, lime W 166 FT CE	white, grey W 166 FT CE	black, white W 166 FT CE
Lens	PC clear UV400 2C-1.2 W1 FTK CE	PC clear UV400 2C-1.2 W1 FTKN CE	PC clear UV400 2C-1.2 W1 FTKN CE	PC clear UV400 2C-1.2 W1 FTKN CE	PC clear UV400 2C-1.2 W1 FTN CE	PC grey 23% UV400 5-2.5 W1 FTKN CE
Weight	21 g	21 g	21 g	21 g	21 g	21 g
Order quantity multiples	10 PC	10 PC	10 PC	10 PC	10 PC	10 PC

MADE IN GERMANY

Safety Spectacles

uvex i-vo



9160065
9160265



9160275



9160520



9160076

uvex i-vo

- functional safety spectacle with a wide range of features and adjustment options
- side arms with multi-incline points and length adjustment allow spectacle to be adapted to ensure a good fit for all facial shapes and head widths
- soft-grip temple ends provide a comfortable, secure fit without pressure
- soft, flexible nose pad for a non-slip and pressure-free fit
- robust polycarbonate lens with uvex's proven supravision coating technology – permanent anti-fog and scratch-resistant lens
- UV400 – 100% protection against dangerous UV radiation up to 400 nm

uvex i-vo	9160065	9160265	9160275	9160520	9160076
Art. no.	9160065	9160265	9160275	9160520	9160076
Version	uvex supravision sapphire	uvex supravision excellence	uvex supravision excellence	uvex supravision sapphire contrast-enhancing	uvex supravision sapphire sunglare filter
Standard	EN 166, EN 170	EN 166, EN 170	EN 166, EN 170	EN 166, EN 170	EN 166, EN 172
Frame	blue, orange W 166 FT CE	blue, orange W 166 FT CE	black, grey W 166 FT CE	blue, orange W 166 FT CE	black, grey W 166 FT CE
Lens	PC clear UV400 2C-1.2 W1 FTK CE	PC clear UV400 2C-1.2 W1 FTKN CE	PC clear UV400 2C-1.2 W1 FTKN CE	PC amber UV400 2C-1.2 W1 FTK CE	PC grey 23% UV400 5-2.5 W1 FTK CE
Weight	33 g	33 g	33 g	33 g	33 g
Order quantity multiples	10 PC	10 PC	10 PC	10 PC	10 PC

MADE IN GERMANY 



You can find more information at uvex-academy.com

Industrial protective eyewear

A practical introductory seminar on the selection, use and benefits of protective eyewear



- The basic applications of safety eyewear, including which products protect against mechanical dangers, chemical and radiation risks (e.g. welding protection), and products designed for specialised applications
- Demonstration and assessment of the dangers posed by mechanical risks, infrared and ultraviolet radiation (e.g. encountered during welding applications or during the use of chemicals), illustrated by case studies
- Assessment of the risk of eye injury in the workplace
- Explanation of how these risks can be dealt with efficiently in each workplace
- Comprehensive overview of the requirements of industrial safety eyewear, standards, applications, risk assessment and how to care for protective eyewear
- Information on the classification of protection products based on their labelling and the areas of application of the various types of equipment

Target group

Those responsible for the work-related health and safety of employees within a company, e.g. health and safety officers, occupational nurses and specialist purchasers

For more information or to book a place, please visit uvex-academy.de, call +49 (0)911 9736 1710 or email academy@uvex.de



Safety Spectacles

uvex meteor · uvex polavision



9134005
9134002

MADE IN GERMANY 

uvex meteor

- classic flat, dual lens safety spectacle with good coverage
- extendable soft-grip side arms offer adaptable, pressure-free comfort and a stable, non-slip fit
- nose bridge designed for all-day comfort
- robust polycarbonate lens with uvex's proven supravision coating technology – both sides scratch-resistant lens
- UV400 – 100% protection against dangerous UV radiation up to 400 nm
- metal-free

uvex meteor		
Art. no.	9134005	9134002
Version	uvex supravision sapphire	uncoated
	lens 56 mm	lens 56 mm
	bridge width 15 mm	bridge width 15 mm
Standard Frame	EN 166, EN 170	EN 166
	grey, transparent	grey transparent
	W 166 F CE	W 166 F CE
Lens	PC clear	HG clear
	UV400	UV330
	2C-1.2 W1 FK	W1 S
Weight	28 g	44 g
Order quantity multiples	5 PC	5 PC



9231960

uvex polavision

- sporty dual lens safety spectacle with polarised filter
- uvex polavision technology protects against reflections and optical irritations outdoors helping to ease eye strain e.g. highly reflective surfaces such as water or glass
- side arms with soft-grip temple ends provide a comfortable, secure fit without pressure
- soft, flexible nose pad for a non-slip and pressure-free fit
- robust polycarbonate lens with UV400 – 100% protection against dangerous UV radiation up to 400 nm

uvex polavision	
Art. no.	9231960
Version	scratch-resistant on both sides
	sunglare filter
Standard Frame	EN 166, EN 172
	black, white
	W 166 F CE
Lens	PC grey 14%
	UV400
	5-3.1 W 1 F CE
Weight	25 g
Order unit	PC



Safety Spectacles & Overspecs

uvex winner · uvex 9161



9159005
9159105



9159118

uvex winner

- classic, rimless metal safety spectacle
- side arms with soft-grip temple ends provide a secure fit without pressure
- soft, adjustable nose pad for a comfortable, non-slip and pressure-free fit
- robust polycarbonate lens with UV400 – 100% protection against dangerous UV radiation up to 400 nm

uvex winner			
Art. no.	9159005	9159105	9159118
Version	scratch-resistant both sides	scratch-resistant, anti-fog	scratch-resistant, anti-fog, sunglare filter
Standard	EN 166, EN 170	EN 166, EN 170	EN 166, EN 172
Frame	gun	gun	gun
Lens	W 166 F CE PC clear UV400	W 166 F CE PC clear UV400	W 166 F CE PC grey 23% UV400
Weight	29 g	29 g	29 g
Order quantity multiples	5 PC	5 PC	5 PC



9161014



9161005
9161305

MADE IN GERMANY

uvex 9161

- robust overspecs for prescription spectacle wearers with flat lens for a wide field of vision
- side arms with multi-incline points and length adjustment allow overspecs to be adapted to ensure a good fit for all facial shapes and head widths (except 9161014)
- soft-grip temple ends provide pressure-free comfort and a stable, non-slip fit (except 9161014)
- nose bridge designed for all-day comfort
- robust polycarbonate lens with uvex's proven supravision coating technology – permanent anti-fog and scratch-resistant lens
- UV400 – 100% protection against dangerous UV radiation up to 400 nm
- metal-free

uvex 9161			
Art. no.	9161014	9161005	9161305
Version	uncoated	uvex supravision sapphire	uvex supravision plus
Standard	EN 166, EN 170	EN 166, EN 170	EN 166, EN 170
Frame	clear	blue, black	blue, black
Lens	W 166 F CE PC clear UV400	W 166 F CE PC clear UV400	W 166 F CE PC clear UV400
Weight	51 g	46 g	46 g
Order quantity multiples	5 PC	5 PC	5 PC

Overspecs

uvex super OTG · uvex super OTG planet



9169065
9169260



9169080



9169295



9169081

uvex super OTG

- classic overspecs for prescription spectacle wearers with an innovative temple concept and a flat lens that offers a wide field of vision
- flexible side arms with soft-grip temple ends provide a comfortable, secure fit without pressure
- nose bridge designed for all-day comfort

- robust polycarbonate lens with uvex's proven supravision coating technology – permanent anti-fog and scratch-resistant lens
- UV400 – 100% protection against dangerous UV radiation up to 400 nm
- a sustainable benefit: lenses can be replaced when required
- metal-free

uvex super OTG			uvex super OTG planet		
Art. no.	9169065	9169080	9169260	9169295	9169081
Replacement lens	–	–	9169255	–	–
Version	uvex supravision sapphire	uvex supravision sapphire	uvex supravision excellence	uvex supravision excellence	uvex supravision sapphire sunglare filter
Standard	EN 166, EN 170	EN 166, EN 170	EN 166, EN 170	EN 166, EN 170	EN 166, EN 172
Frame	blue, light grey W 166 FT CE	black, light grey W 166 FT CE	blue, light grey W 166 FT CE	anthracite, jade W 166 FT CE	black, light grey W 166 FT CE
Lens	PC clear UV400 2C-1.2 W1 FTK CE	PC clear UV400 2C-1.2 W1 FTK CE	PC clear UV400 2C-1.2 W1 FTKN CE	PC clear (mass balanced) UV400 2C-1.2 W1 FTKN CE	PC grey 23% UV400 5-2.5 W1 FTK CE
Weight	37 g	37 g	37 g	37 g	37 g
Order quantity multiples	8 PC	8 PC	8 PC	8 PC	8 PC



Overspecs

uvex super f OTG



9169261
9169585



9169415
9169500



9169164



9169586



9169850



9169615

uvex super f OTG

- classic overspecs for prescription spectacle wearers with a flat lens for a wide field of vision, designed for maximum wearer acceptance
- side arms with soft-grip temple ends provide a comfortable, secure fit without pressure
- nose bridge designed for all-day comfort
- robust polycarbonate lens with uvex's proven supravision coating technology – permanent anti-fog and scratch-resistant lens
- UV400 – 100 % protection against dangerous UV radiation up to 400 nm
- a sustainable benefit: lenses can be replaced when required

uvex super f OTG								
Art. no.	9169585	9169261	9169415	9169500	9169164	9169586	9169850	9169615
Replacement lens	-	9169255	-	-	-	-	-	-
Version	uvex supravision sapphire	uvex supravision excellence	uvex supravision ETC	uvex supravision clean autoclavable (20 cycles)	uvex supravision excellence sunglare filter	uvex supravision sapphire sunglare filter	uvex supravision variomatic	uvex supravision sapphire blocks blue light to 525 nm
Standard Frame	EN 166, EN 170 black, clear W 166 FT CE	EN 166, EN 170 black, clear W 166 FT CE	EN 166, EN 170 white, light blue W 166 FT CE	EN 166, EN 170 white, light blue W 166 FT CE	EN 166, EN 172 black, clear W 166 FT CE	EN 166, EN 172 black, clear W 166 FT CE	EN 166, EN 170 black, clear W 166 FT CE	EN 166, EN 170 black, clear W 166 FT CE
Lens	PC clear UV400 2C-1.2 W1 FTK CE	PC clear UV400 2C-1.2 W1 FTKN CE	PC clear UV400 2C-1.2 W1 FTKN CE	PC clear UV400 2C-1.2 1 FTKN CE	PC CBR65 UV400 5-1.4 W1 FTKN CE	PC grey 23% UV400 5-2.5 W1 FTK CE	PC light green UV400 2-1.2 W1 FTKN CE	PC orange UV525 2-1.4 W1 FTK CE
Weight	39 g	39 g	39 g	39 g	39 g	39 g	39 g	39 g
Order quantity multiples/	8 PC	8 PC	8 PC	8 PC	8 PC	8 PC	PC	8 PC

Safety Goggles

uvex megasonic · uvex megasonic planet



9320415
9320470

9320265



9320295



9320475



9320500



9320223



9320281

uvex megasonic

- functional safety goggle in ski goggle design with a truly panoramic field of vision
- unique frameless lens design for edge-to-edge optical clarity and increased safety
- soft, adaptive face seal providing a universal fit for different head and facial shapes as well as a tight fit without pressure points
- generous internal volume to accommodate prescription spectacles and frame recesses to locate the side arms ensuring a comfortable fit
- indirect ventilation system increases air circulation

- length-adjustable 30 mm wide textile headband for optimal low pressure hold and individual adaptability
- robust polycarbonate lens with uvex's proven supravision coating technology – permanent anti-fog and scratch-resistant lens
- UV400 – 100% protection against dangerous UV radiation up to 400 nm
- a sustainable benefit: lenses and headbands can be replaced when required
- metal-free



reddot winner 2020



Further information can be found at uvex-safety.com/en/megasonic (or scan the QR code).

uvex megasonic	uvex megasonic planet		uvex megasonic planet		uvex megasonic planet		uvex megasonic planet	
Art. no.	9320265	9320295	9320415	9320470	9320475	9320500	9320223	9320281
Replacement lens	9320255	-	9320455	9320255	-	9320259	-	9320257
Replacement headband	9320011	-	9320011	9320011	-	-	-	-
Version	uvex supravision excellence	uvex supravision excellence	uvex supravision ETC	uvex supravision extreme, reduced ventilation	uvex supravision extreme, closed ventilation (gas-proof)	uvex supravision clean autoclavable (20 cycles)	uvex supravision excellence sunglare filter	uvex supravision excellence sunglare filter
Standard Frame	EN 166, EN 170 anthracite, blue W 166 34 BT CE	EN 166, EN 170 anthracite, jade W 166 34 BT CE	EN 166, EN 170 anthracite, blue W 166 34 BT CE	EN 166, EN 170 anthracite, blue W 166 34 BT CE	EN 166, EN 170 anthracite, lime W 166 345 BT CE	EN 166, EN 170 transparent, white W 166 34 F CE	EN 166, EN 172 black, grey W 166 34 BT CE	EN 166, EN 172 anthracite, lime W 166 34 BT CE
Lens	PC clear	PC clear (mass balanced)	PC clear	PC clear	PC clear	PC clear	PC CBR23	PC grey 23%
Weight	UV400 2C-1.2 W1 BTKN CE 96 g	UV400 2C-1.2 W1 BTKN CE 96 g	UV400 2C-1.2 W1 BTKN CE 96 g	UV400 2C-1.2 W1 BTKN CE 98 g	UV400 2C-1.2 W1 BTKN CE 100 g	UV400 2C-1.2 W1 FKN CE 107 g	UV400 5-2.5 W1 BTKN CE 96 g	UV400 5-2.5 W1 BTKN CE 96 g
Order quantity multiples	4 PC	4 PC	4 PC	4 ST	4 PC	4 PC	4 PC	4 PC

MADE IN GERMANY



Safety Goggles

uvex pheos cx2 sonic · uvex u-sonic



9309275



9309064



9309286

uvex pheos cx2 sonic

- sporty, compact and extremely lightweight safety goggle
- very soft and flexible, ergonomic face seal for a custom fit and ultimate comfort
- indirect ventilation system increases air circulation
- very light, length-adjustable textile headband for a secure fit and individual adaptability
- robust polycarbonate lenses with uvex's proven supravision coating technology – permanent anti-fog and scratch-resistant lens
- UV400 – 100% protection against dangerous UV radiation up to 400 nm
- metal-free

uvex pheos cx2 sonic			
Art. no.	9309275	9309064	9309286
Version	uvex supravision extreme	uvex supravision extreme	uvex supravision extreme
Standard	EN 166, EN 170	EN 166, EN 172	EN 166, EN 172
Frame	white, black W 166 34 BT CE	white, black W 166 34 BT CE	white, black W 166 34 BT CE
Lens	PC clear UV400 2C-1.2 W1 BTKN CE	PC CBR65 UV400 5-1.4 W1 BTKN CE	PC grey 23% UV400 5-2.5 W1 BTKN CE
Weight	34 g	34 g	34 g
Order quantity multiples	10 PC	10 PC	10 PC



9308145
9308245

uvex u-sonic

- sporty, compact and lightweight goggles
- soft, flexible face seal naturally moulds to any facial shape
- indirect ventilation system increases air circulation
- length-adjustable textile headband for a secure fit and individual adaptability
- robust polycarbonate lens with uvex's proven supravision coating technology – permanent anti-fog and scratch-resistant lens
- UV400 – 100% protection against dangerous UV radiation up to 400 nm
- metal-free

uvex u-sonic		
Art. no.	9308145	9308245
Version	uvex supravision plus	uvex supravision excellence
Standard	EN 166, EN 170	EN 166, EN 170
Frame	grey, green W 166 34 B CE	grey, green W 166 34 B CE
Lens	PC clear UV400 2C-1.2 W1 BKN CE	PC clear UV400 2C-1.2 W1 BKN CE
Weight	72g	72g
Order quantity multiples	5 PC	5 PC

uvex

uvex CR

Autoclave safety eyewear that goes further

Innovative coating technology –
the first autoclavable safety eyewear
with anti-fog performance

uvex has developed the first autoclavable safety eyewear with anti-fog coating for specialist requirements in laboratories, clinics, cleanrooms and food manufacturing. From ultra-light safety spectacles and goggles with a panoramic lens, the uvex CR is the ideal safety eyewear for all areas of application and specifically have been designed for repeated autoclave sterilisation (20 times for 20 minutes each at a max. of 121°C).

uvex CR – professional safety eyewear that compliments hygiene standards.



9169500

uvex super f OTG CR

- classic overspecs for prescription spectacle wearers with a flat lens for wide field of vision, designed for maximum wearer acceptance
- side arms with soft-grip temple ends provide a comfortable, secure fit without pressure
- nose bridge designed for all-day comfort

- robust polycarbonate lens with uvex's proven infraradur coating technology – permanent anti-fog and scratch-resistant lens
- UV400 – 100% protection against dangerous UV radiation up to 400 nm



9320500



9302500

uvex megasonic CR

- functional safety goggles in ski goggle design with a truly panoramic field of vision
- unique frameless lens design for edge-to-edge optical clarity and increased safety
- soft, adaptive face seal providing a universal fit for different head and facial shapes as well as a tight fit without pressure points
- generous internal volume to accommodate prescription spectacles and frame recesses to locate the side arms ensuring a comfortable fit
- indirect ventilation system increases air circulation
- length-adjustable 30 mm wide silicone headband for optimal low pressure hold and individual adaptability
- robust polycarbonate lens with uvex's proven supravision coating technology – permanent anti-fog and scratch-resistant lens
- UV400 – 100% protection against dangerous UV radiation up to 400 nm
- a sustainable benefit: lenses can be replaced when required
- metal-free

uvex ultrasonic CR

- functional safety goggle with panoramic lens suitable for a wide range of applications
- soft, flexible face seal naturally moulds to any facial shape
- generous internal volume to accommodate prescription spectacles and ensure a comfortable fit
- indirect ventilation system increases air circulation
- length-adjustable silicone headband for a secure fit and individual adaptability
- robust polycarbonate lens with uvex's proven supravision coating technology – permanent anti-fog and scratch-resistant lens
- UV400 – 100% protection against dangerous UV radiation up to 400 nm
- a sustainable benefit: lenses can be replaced when required
- metal-free

MADE IN GERMANY 



Safety Goggles

uvex ultrasonic · uvex ultrasonic planet



9302805

9302245



9302285



9302290



9302601



9302600



9302500



9302286

uvex ultrasonic

- functional safety goggle with panoramic lens suitable for a wide range of applications
- soft, flexible face seal naturally moulds to any facial shape
- generous internal volume to accommodate prescription spectacles and ensure a comfortable fit
- indirect ventilation system increases air circulation
- length-adjustable textile or silicone headband for a secure fit and individual adaptability

- robust polycarbonate lens with uvex's proven supravision coating technology – permanent anti-fog and scratch-resistant lens
- UV400 – 100% protection against dangerous UV radiation up to 400 nm
- a sustainable benefit: lenses can be replaced when required
- metal-free

uvex ultrasonic			uvex ultrasonic planet	
Art. no.	9302245	9302285	9302290	9302805
Replacement lens	9302255	9302255	-	-
Version	uvex supravision excellence	uvex supravision excellence	uvex supravision excellence	uvex supravision extreme
Standard	EN 166, EN 170	EN 166, EN 170	EN 166, EN 170	EN 166, EN 170
Frame	grey, orange	black, grey	anthracite, jade	grey, orange
	W 166 34 B CE	W 166 34 B CE	W 166 34 B CE	W 166 34 B CE
Lens	PC clear	PC clear	PC clear (mass balanced)	PC clear
	UV400	UV400	UV400	UV400
	2C-1.2 W1 BKN CE	2C-1.2 W1 BKN CE	2C-1.2 W1 BKN CE	2C-1.2 W1 BKN CE
Weight	83 g	83 g	83 g	83 g
Order quantity multiples	4 PC	4 PC	4 PC	4 PC

uvex ultrasonic				
Art. no.	9302601	9302600	9302500	9302286
Replacement lens	-	-	9302259	9302256
Version	uvex supravision extreme reduced ventilation	uvex supravision extreme reduced ventilation	uvex supravision clean autoclavable (20 cycles)	uvex supravision excellence sunglare filter
Standard	EN 166, EN 170	EN 166, EN 170	EN 166, EN 170	EN 166, EN 172
Frame	black, red	blue, grey	transparent, white	black, grey
	W 166 34 B CE	W 166 34 B CE	W 166 34 B CE	W 166 34 B CE
Lens	PC clear	PC clear	PC clear	PC grey 23%
	UV400	UV400	UV400	UV400
	2C-1.2 W1 BKN CE	2C-1.2 W1 BKN CE	2C-1.2 W1 BKN CE	5-2.5 W1 BKN CE
Weight	95 g	95 g	95 g	83 g
Order quantity multiples	4 PC	4 PC	4 PC	4 PC

MADE IN GERMANY

Safety Goggles

uvex ultravision



9301714



9301906



9301716

Please note:
CA lenses do not fit the PC models
and vice-versa.

uvex ultravision

- classic safety goggle suitable for a wide range of applications
- flexible face seal naturally moulds to any facial shape
- generous internal volume accommodating prescription spectacles and frame recesses to locate the side arms ensuring a comfortable fit
- indirect ventilation system increases air circulation
- length-adjustable textile or neoprene headband for a secure fit and individual adaptability
- robust polycarbonate lens with uvex's proven supravision coating technology – permanent anti-fog and scratch-resistant lens
- UV400 – 100% protection against dangerous UV radiation up to 400 nm
- also available with a cellulose acetate lens featuring anti-fog performance on the inside and UV380 protection
- a sustainable benefit: lenses can be replaced when required
- metal-free

uvex ultravision			
Art. no.	9301714	9301906	9301716
Replacement lens	9300517	9300956	9300517
Version	anti-fog on the inside	anti-fog on the inside wide nose piece, particularly well suited in combination with dust masks	anti-fog on the inside with foam layer
Standard	EN 166, EN 170	EN 166, EN 170	EN 166, EN 170
Frame	transparent grey W 166 34 F CE	transparent grey W 166 3 F CE	transparent grey W 166 34 F CE
Lens	CA clear UV380 2C-1.2 W1 FN CE	CA clear UV380 2C-1.2 W1 FN CE	CA clear UV380 2C-1.2 W1 FN CE
Weight	116 g	130 g	118 g
Order quantity multiples	4 PC	4 PC	4 PC

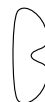

Safety Goggles

uvex ultravision



9301605



9301116



9301105



9301626



9301813



9301815



9301613



9301633

uvex ultravision				
Art. no.	9301605	9301116	9301105	9301626
Replacement lens	-	-	9301255	9301255
Tear-off films	-	-	-	-
Version	uvex supravision plus	uvex supravision plus with foam layer	uvex supravision excellence	uvex supravision excellence with foam layer
Standard	EN 166, EN 170	EN 166, EN 170	EN 166, EN 170	EN 166, EN 170
Frame	transparent grey W 166 34 BT CE	transparent grey W 166 34 BT CE	transparent grey W 166 34 BT CE	transparent grey W 166 34 BT CE
Lens	PC clear UV400 2C-1.2 W1 BTKN CE	PC clear UV400 2C-1.2 W1 BTKN CE	PC clear UV400 2C-1.2 W1 BTKN CE	PC clear UV400 2C-1.2 W1 BTKN CE
Weight	131 g	134 g	131 g	134 g
Order quantity multiples	4 PC	4 PC	4 PC	4 PC

uvex ultravision				
Art. no.	9301813	9301815	9301613	9301633
Replacement lens	9301255	9301255	9301255	9301255
Tear-off films	9300316	-	-	-
Version	uvex supravision excellence with tear-off films, 2 units	uvex supravision excellence top ventilation closed	uvex supravision excellence closed ventilation (gas-proof)	uvex supravision excellence closed ventilation (gas-proof) heat-resistant frame material
Standard	EN 166, EN 170	EN 166, EN 170	EN 166, EN 170	EN 166, EN 170
Frame	transparent grey W 166 34 BT CE	transparent grey W 166 34 BT CE	yellow W 166 345 BT CE	red W 166 345 BT CE
Lens	PC clear UV400 2C-1.2 W1 BTKN CE	PC clear UV400 2C-1.2 W1 BTKN CE	PC clear UV400 2C-1.2 W1 BTKN CE	PC clear UV400 2C-1.2 W1 BTKN CE
Weight	126 g	131 g	133 g	133 g
Order quantity multiples	4 PC	4 PC	4 PC	4 PC

MADE IN GERMANY

Safety Goggles

uvex ultravision faceguard · uvex ultravision faceguard



9301555
Safety Goggle: 9301105

uvex ultravision faceguard

- combination of safety goggle with face guard
- protection for eyes and face
- lifting mechanism allows flexible handling during use e.g. communication, drinking, etc.

uvex ultravision	Goggles with face protection
Art. no.	9301555
Version	Goggles with mit uvex supravision excellence (9301105) with faceguard (9301318)
Standard	EN 166, EN 170
Frame	transparent grey W 166 34 BT CE
Lens	PC clear UV400 2C-1.2 W1 BTKN CE
Weight	212 g
Order quantity multiples/ Order unit	4 PC



9301317



9301318

Faceguard for uvex ultravision

- additional face protection
- 9301318: lifting mechanism allows flexible handling during use e.g. communication, drinking, etc.
- can be mounted to all uvex ultravision models with a PC lens

uvex ultravision faceguard		
Art. no.	9301317	9301318
Version	for all models 9301 with PC lens without spectacles uncoated	for all models 9301 with PC lens without spectacles uncoated
Standard	-	-
Frame	transparent CE	transparent CE
Weight	64 g	81 g
Order quantity multiples	PC	PC

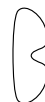

Safety Goggles

uvex 9305 · uvex 9405



9305514



9305714

uvex 9305

- classic safety goggle
- flexible face seal naturally moulds to any facial shape
- internal volume comfortably accommodates prescription spectacles
- indirect ventilation system increases air circulation
- length-adjustable textile or rubber headband for a secure fit and individual adaptability
- cellulose acetate lens with anti-fog performance on the inside and UV380 protection
- metal-free

uvex 9305		
Art. no.	9305514	9305714
Version	anti-fog on the inside with rubber headband	anti-fog on the inside with textile headband
Standard	EN 166, EN 170	EN 166, EN 170
Frame	transparent grey	transparent grey
Lens	W 166 34 F CE	W 166 34 F CE
	CA clear	CA clear
	UV380	UV380
	2C-1.2 W1 FN CE	2C-1.2 W1 FN CE
Weight	95 g	91 g
Order quantity multiples	4 PC	4 PC



9405714

uvex 9405

- classic safety goggle
- flexible face seal naturally moulds to any facial shape
- internal volume comfortably accommodates prescription spectacles
- indirect ventilation system increases air circulation
- length-adjustable textile headband for a secure fit and individual adaptability
- cellulose acetate lens with anti-fog performance on the inside and UV380 protection
- metal-free

uvex 9405	
Art. no.	9405714
Version	anti-fog on the inside
Standard	EN 166, EN 170
Frame	transparent grey
Lens	W 166 34 F CE
	CA clear
	UV380
	2C-1.2 W1 FN CE
Weight	84 g
Order quantity multiples	4 PC

Infrared protection uvex IR-ex safety spectacles

Preventive protection against infrared radiation

Infrared radiation (IR radiation) is also referred to as heat radiation, as it is perceived as such.

Strictly speaking, heat radiation ranges from infrared to visible light (VIS) up to ultraviolet (UV) – depending on the temperature.

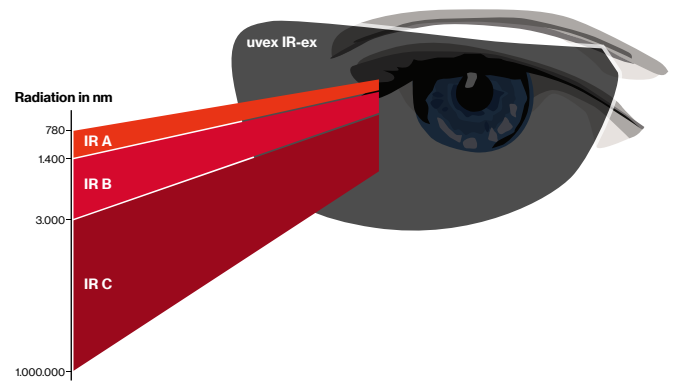
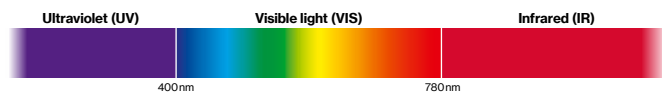

IR radiation cannot be perceived by the human eye. It extends over the electromagnetic spectrum from 780 nm to 1 mm (1,000,000 nm).

IR radiation is divided into three spectra:

- IR A (780 nm–1400 nm)
- IR B (1400 nm–3000 nm)
- IR C (3000 nm–1 mm)

The invisible danger

The effect of infrared radiation on human tissue can be harmful.

Since it is not immediately noticeable, infrared radiation can increase the risk of permanent eye damage, such as cataracts.

Principle: The greater the wavelength, the lower the penetration depth into the tissue.

Caution: For applications requiring prolonged or repeated viewing of glowing objects, it is **essential** that suitable safety eyewear be worn.

uvex IR-ex safety spectacles

100% **UV400** protection

Durable **uvex supravision coating:**

- K – extremely scratch-resistant on the outside
- N – permanently anti-fog on the inside

Additional T certification on lens and side arm

Mechanical strength F at extreme temperatures



Multi-standard compliant:

EN171, EN169, JIS T8141, ANSI/ISEA Z87.1

Available in **three protection levels 1.7/3/5**



Maximum high transmission in visible spectrum

Levels of infrared protection and recommendations for use according to EN 171

Level of protection	Recommended use in accordance with EN 171
4-1.7	average temperature of the radiation source up to 1090°C*
4-2	average temperature of the radiation source up to 1110°C (forges)
4-3	average temperature of the radiation source 1190°C (glass blowing)*
4-4	average temperature of the radiation source 1290°C (foundries)
4-5	average temperature of the radiation source 1390°C (steel foundries)*
4-6	average temperature of the radiation source 1510°C (iron foundries)



You can find more information at uvex-safety.com/ir-ex

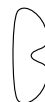

Infrared protection

uvex pheos cx2 · uvex super f OTG



9198171



9198173



9198175

uvex pheos cx2

- sporty-looking safety spectacles with high wearer acceptance
- x-tended eyeshield: soft seal frame technology wraps around the brow providing protection from particle ingress
- ergonomically shaped side arms with soft-grip temple ends provide a comfortable, secure fit without pressure
- soft, flexible nose pad adapts to the wearer, delivering a non-slip and pressure-free fit
- robust polycarbonate lens with uvex's proven infraradur coating technology – permanent anti-fog and scratch-resistant lens
- IR protection according to EN 171 and welding protection according to EN 169 with perfect colour recognition
- UV400 – 100% protection against dangerous UV radiation up to 400 nm
- metal-free

uvex pheos cx2			
Art. no.	9198171	9198173	9198175
Version	uvex infradur plus	uvex infradur plus	uvex infradur plus
Standard	Infrared protection level 1.7	Infrared protection level 3	Infrared protection level 5
Frame	EN 166, EN 171, EN 169, EN 170	EN 166, EN 171, EN 169, EN 170	EN 166, EN 171, EN 169, EN 170
Lens	black, red	black, red	black, red
Weight	W 166 FT CE	W 166 FT CE	W 166 FT CE
Order quantity multiples	PC grey IR-ex 1.7	PC grey IR-ex 3	PC grey IR-ex 5
	UV400 + IR	UV400 + IR	UV400 + IR
	4C-1.7 W1 FTKN CE	4C-3 W1 FTKN CE	4C-5 W1 FTKN CE
	1.7 W1 FTKN CE	3 W1 FTKN CE	5 W1 FTKN CE
	2C-1.7 W1 FTKN CE	2C-3 W1 FTKN CE	2C-5 W1 FTKN CE
	28 g	28 g	28 g
	10 PC	10 PC	10 PC



9169171



9169173



9169175

uvex super f OTG

- classic overspecs for prescription spectacle wearers with a flat lens for a wide field of vision, designed for maximum wearer acceptance
- side arms with soft-grip temple ends provide a comfortable, secure fit without pressure
- nose bridge designed for all-day comfort
- robust polycarbonate lens with uvex's proven infradur coating technology – permanent anti-fog and scratch-resistant lens
- IR protection according to EN 171 and welding protection according to EN 169 with perfect colour recognition
- UV400 – 100% protection against dangerous UV radiation up to 400 nm

uvex super f OTG			
Art. no.	9169171	9169173	9169175
Version	uvex infradur plus	uvex infradur plus	uvex infradur plus
Standard	Infrared protection level 1.7	Infrared protection level 3	Infrared protection level 5
Frame	EN 166, EN 171, EN 169, EN 170	EN 166, EN 171, EN 169, EN 170	EN 166, EN 171, EN 169, EN 170
Lens	black, red	black, red	black, red
Weight	W 166 FT CE	W 166 FT CE	W 166 FT CE
Order quantity multiples	PC grey IR-ex 1.7	PC grey IR-ex 3	PC grey IR-ex 5
	UV400 + IR	UV400 + IR	UV400 + IR
	4C-1.7 W1 FTKN CE	4C-3 W1 FTKN CE	4C-5 W1 FTKN CE
	1.7 W1 FTKN CE	3 W1 FTKN CE	5 W1 FTKN CE
	2C-1.7 W1 FTKN CE	2C-3 W1 FTKN CE	2C-5 W1 FTKN CE
	39 g	39 g	39 g
	8 PC	8 PC	8 PC

Welding Protection

A new generation of welding protection eyewear available with different grey-tint lenses and protection classes. The innovative technology affords protection from UV and infrared light while maintaining perfect colour recognition in line with uvex sunglare filters.

The special uvex infradur plus coating has anti-fog properties which prevents the inside of the lenses misting up and the extreme scratch-resistance on the outside keeps damage from welding sparks to an absolute minimum.

With various welding safety spectacles and goggle solutions, there is something for everyone – enhancing comfort and the wearer experience.

N.B.: Do not use for electric welding.

All welding products have polycarbonate lenses providing protection against impact as well as UV rays, IR rays and visible glare.

The products do not provide protection against laser beams!

For expert advice on safety and in selecting the right laser protection eyewear, talk to our specialists

laservision

Call them on +49 (0)911 9736 8100.

uvex-laservision.com



New grey tint offers increased impact protection than traditional green welding tint products

IR/UV filter for improved safety

Sun/glare protection filters



Perfect colour recognition

Marking K and N for uvex infradur plus coated lenses

Levels of welding protection and recommendations for use according to EN 169

Level of protection	Use
1.7	For welding assistants, protection against UV radiation and bright scattered light
2	Lightweight oxyacetylene cutting
3	Flame derusting, flame cutting, lightweight oxyacetylene cutting
4	Welding and hard soldering with up to 70 l/h of acetylene, flame cutting with up to 900 l/h of oxygen, steel and grey cast iron welding, lightweight oxyacetylene cutting
5	Welding and hard soldering with 70 to 200 l/h of acetylene, flame cutting with 2000 to 4000 l/h of oxygen
6	Welding and hard soldering with 200 to 800 l/h of acetylene, flame cutting with 2000 to 4000 l/h of oxygen

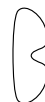

Welding Protection

uvex i-5 · uvex astrospec 2.0 · uvex 9161



9183041



9183043



9183045

uvex i-5

- sporty premium quality welding safety spectacle with a range of adaptive features
- x-tended eyeshield: soft seal frame technology wraps around the brow providing protection from particle ingress
- x-tended sideshield offers additional protection from hazards
- ergonomically shaped side arms with multi-incline points and length adjustment allow a high level of individualisation to ensure a good fit for all facial shapes and head widths
- soft-grip temple ends provide a comfortable, secure fit without pressure
- soft, flexible nose pad adapts to the wearer, delivering a non-slip and pressure-free fit
- robust polycarbonate lens with uvex's proven infradur coating technology – permanent anti-fog and scratch-resistant lens
- IR protection according to EN 169 with perfect colour recognition according to EN 172
- UV400 – 100% protection against dangerous UV radiation up to 400 nm
- optional clip-in frame seal provides extra protection against particles, dirt and dust
- metal-free

uvex i-5			
Art. no.	9183041	9183043	9183045
Version	uvex infradur plus welding protection level 1.7	uvex infradur plus welding protection level 3	uvex infradur plus welding protection level 5
Standard	EN 166, EN 169	EN 166, EN 169	EN 166, EN 169
Frame	black, green W 166 FT CE	black, green W 166 FT CE	black, green W 166 FT CE
Lens	PC grey UV400 + IR 1.7 W1 FTKN CE	PC grey UV400 + IR 3 W1 FTKN CE	PC grey UV400 + IR 5 W1 FTKN CE
Weight	29 g	29 g	29 g
Order quantity multiples	10 PC	10 PC	10 PC



9164145



9161145

uvex astrospec 2.0

- classic welding safety spectacle with flat lens for a wide field of vision
- ergonomically shaped side arms with multi-incline points allow for a high level of individualisation to ensure a good fit for all facial shapes and head widths
- side arms with soft-grip temple ends provide a comfortable, secure fit without pressure
- nose bridge designed for all-day comfort
- robust polycarbonate lens with uvex's proven infradur coating technology – permanent anti-fog and scratch-resistant lens
- IR protection according to EN 169 with perfect colour recognition according to EN 172
- UV400 – 100% protection against dangerous UV radiation up to 400 nm

uvex strospec 2.0	
Art. no.	9164145
Version	uvex infradur plus welding protection level 5
Standard	EN 166, EN 169
Frame	black, green W 166 FT CE
Lens	PC grey UV400 + IR 5 W1 FTKN CE
Weight	42 g
Order quantity multiples	10 PC

uvex 9161

- robust welding overspecs for prescription spectacle wearers with a flat lens for a wide field of vision
- side arms with multi-incline points and length adjustment allow spectacle to be adapted to ensure a good fit for all facial shapes and head widths
- side arms with soft-grip temple ends provide a comfortable, secure fit without pressure
- nose bridge designed for all-day comfort
- robust polycarbonate lens with uvex's proven infradur coating technology – permanent anti-fog and scratch-resistant lens
- IR protection according to EN 169 with perfect colour recognition according to EN 172
- UV400 – 100% protection against dangerous UV radiation up to 400 nm
- metal-free

uvex 9161	
Art. no.	9161145
Version	uvex infradur welding protection level 5
Standard	EN 166, EN 169
Frame	black, green W 166 F CE
Lens	PC grey UV400 + IR 5 W1 FK CE
Weight	46 g
Order quantity multiples	5 PC

MADE IN GERMANY

Welding Protection

uvex super f OTG · uvex megasonic · uvex ultrasonic



9169541



9169543



9169545

uvex super f OTG

- classic welding overspecs for prescription spectacle wearers with a flat lens for wide field of vision, designed for maximum wearer acceptance
- side arms with soft-grip temple ends provide a comfortable, secure fit without pressure
- nose bridge designed for all-day comfort
- robust polycarbonate lens with uvex's proven infradur coating technology – permanent anti-fog and scratch-resistant lens
- IR protection according to EN 169 with perfect colour recognition according to EN 172
- UV400 – 100% protection against dangerous UV radiation up to 400 nm

uvex super f OTG

Art. no.	9169541	9169543	9169545
Version	uvex infradur plus	uvex infradur plus	uvex infradur plus
	welding protection level 1.7	welding protection level 3	welding protection level 5
Standard	EN 166, EN 169	EN 166, EN 169	EN 166, EN 169
Frame	black, green	black, green	black, green
	W 166 FT CE	W 166 FT CE	W 166 FT CE
Lens	PC grey	PC grey	PC grey
	UV400 + IR	UV400 + IR	UV400 + IR
	1.7 W 1 FTKN CE	3 W 1 FTKN CE	5 W 1 FTKN CE
Weight	39 g	39 g	39 g
Order quantity multiples	8 PC	8 PC	8 PC



9320045



9302045

uvex megasonic

- functional welding safety goggle in a ski goggle design and a truly panoramic field of vision
- unique frameless lens design for edge-to-edge optical clarity and increased safety
- soft, adaptive face seal providing a universal fit for different head and face shapes as well as a tight fit without pressure points
- generous internal volume to accommodate prescription eyewear and frame recesses to locate the side arms ensuring a comfortable fit
- indirect ventilation system increases air circulation
- length-adjustable 30 mm wide textile headband
- robust polycarbonate lens with uvex's proven infradur coating technology – permanent anti-fog and scratch-resistant lens
- IR protection according to EN 169 with perfect colour recognition according to EN 172
- UV400 – 100% protection against dangerous UV radiation up to 400 nm
- metal-free

uvex megasonic

Art. no.	9320045
Replacement lens	9320055
Version	uvex infradur plus
	welding protection level 5
Standard	EN 166, EN 169
Frame	black
	W 166 34 BT CE
Lens	PC grey
	UV400 + IR
	5 W1 BTKN CE
Weight	96 g
Order quantity multiples	4 PC

uvex ultrasonic

- functional welding safety goggle with panoramic and flip-up lens for an increased use of applications
- soft, flexible face seal naturally moulds to any facial shape
- generous internal volume to accommodate prescription spectacles and ensure a comfortable fit
- indirect ventilation system increases air circulation
- length-adjustable textile headband for a secure fit and individual adaptability
- robust polycarbonate lens with uvex's proven supravision and infradur coating technology – permanent anti-fog and scratch-resistant lens
- IR protection according to EN 169 with perfect colour recognition according to EN 172
- UV400 – 100% protection against dangerous UV radiation up to 400 nm
- a sustainable benefit: lenses can be replaced when required
- metal-free

uvex ultrasonic

Art. no.	9302045
Replacement lens flip-up	9302085
Version	uvex supravision excellence
	with flip-up and easily replaceable filter
Standard	EN 166, EN 169, EN 170
Frame	black, green
Lens	W 166 34 B CE
	PC clear, UV400
Additional lens	2C-1.2 W1 BKN CE
	PC grey, UV400 + IR
	uvex infradur, 5 W1 CE
	welding protection level 5
Weight	123 g
Order quantity multiples	4 PC

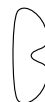

Accessories

uvex cleaning accessories · Presentation



9970005



9972101



9963005

uvex eyewear cleaning station

- including
2 x 9971000
1 x 9972103
1 x 9973101

Plastic pump

- for uvex cleaning fluid 9972103

uvex cleaning fluid

- 500 ml cleaning fluid
- suitable for all uvex lenses

Cleaning paper

- replacement pack silicone-free paper
- approx. 760 sheets
- antistatic
- suitable for all uvex lenses

Magnetic wall bracket

- for easy mounting of the uvex cleaning station (9970005)

uvex eyewear cleaning station	
Art. no.	9970005
Order unit	PC

Plastic pump	
Art. no.	9973101
Order unit	PC

uvex cleaning fluid	
Art. no.	9972103
Content	500 ml
Order unit	PC

Cleaning papers	
Art. no.	9971000
Order unit	PC

Magnetic wall bracket	
Art. no.	9963004
Order unit	PC

uvex cleaning fluid

- 500 ml cleaning fluid
- suitable for all uvex lenses
- Note: does not fit in the cleaning stations (9970005 and 9970002).

uvex cleaning fluid	
Art. no.	9972101
Content	500 ml
Order unit	PC

uvex lens cleaning towelettes

- 100 towelettes per box
- individually packed
- silicone-free
- not antistatic
- suitable for all uvex lenses

uvex cleaning towelettes	
Art. no.	9963005
Order unit	PC



9972130



9957503

uvex microfibre cloth

- suitable for cleaning all uvex lenses

uvex microfibre cloth	
Art. no.	9972130
Order unit	BG
Content	5 PC

uvex display

- with integrated mirror
- for four safety spectacles and one safety goggle

uvex Display	
Art. no.	9957503
Order unit	PC

Accessories

Storage



9954600

uvex eyewear case

- extremely robust hard case for protection against external influences
- soft embedded inside
- with belt loop
- practical snap hook
- especially suitable for curved safety eyewear (e.g. uvex i-vo)

uvex eyewear case

Art. no. 9954600
Order quantity multiples 10 PC



9954500

uvex eyewear case

- robust case
- additional space for spare lens
- reinforced zipper
- with belt loop
- suitable for all uvex safety spectacles



9954501

uvex eyewear case

- large and robust case
- additional space for spare lens
- with belt loop
- suitable for all uvex safety spectacles and goggles

uvex eyewear case

Art. no. 9954600
Order quantity multiples 10 PC

Art. no. 9954500
Order quantity multiples 10 PC

Art. no. 9954501
Order quantity multiples 10 PC



9954355

uvex microfibre bag

- elegant microfibre bag
- suitable for all uvex safety spectacles and safety overspecs

uvex microfibre bag

Art. no. 9954355
Order quantity multiples 10 PC



9954395

uvex microfibre bag

- elegant microfibre bag
- suitable for all uvex safety spectacles and safety overspecs
- made from 100% recycled PET bottles

uvex planet microfibre bag

Art. no. 9954395
Order quantity multiples 10 PC



9954360

uvex microfibre bag

- elegant microfibre bag
- suitable for all uvex safety overspecs and safety goggles

uvex microfibre bag

Art. no. 9954360
Order quantity multiples 4 PC



9954550

uvex eyewear case

- flexible case made of robust nylon material
- Velcro fastener individually adjustable
- suitable for all uvex safety spectacles

uvex eyewear case

Art. no. 9954550
Order unit 10 PC



9954514

uvex eyewear case

- extremely robust hard case for protection against external influences
- soft embedded inside
- practical snap hook
- ideal for storing goggles
- suitable for all uvex safety goggles

uvex eyewear case

Art. no. 9954514
Order unit 4 PC



9957502

uvex SECU box

- storage box for wall mounting
- for spectacles and goggles: 2 safety goggles or 3 safety spectacles or 1 safety goggles and 2 safety spectacles

uvex SECU box

Art. no. 9957502
Order unit PC



Accessories

uvex hang-cords · uvex headband



9958017

uvex eyewear cord

- individual length adjustment
- for compatibility with uvex models please see overview on p. 76



9958030

uvex eyewear cord

- individual length adjustment
- for compatibility with uvex models please see overview on p. 76
- made from 100% recycled PET bottles



9959002

uvex eyewear cord

- suitable for all uvex safety spectacles

uvex eyewear cord		uvex planet eyewear cord	
Art. no.	9958017	9958030	9959002
Order quantity multiples	10 PC	10 PC	10 PC

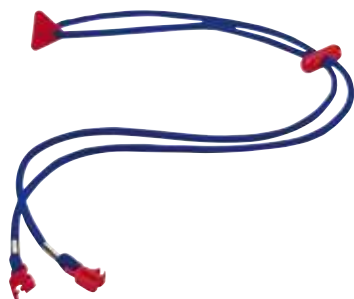

9959003

uvex eyewear cord

- individual length adjustment
- for compatibility with uvex models please see overview on p. 76



9959004

uvex eyewear cord

- individual length adjustment
- metal-free
- for compatibility with uvex models please see overview on p. 76

uvex eyewear cord			
Art. no.	9959003	9959004	
Order quantity multiples	10 PC	10 PC	



9958020

uvex pheos headband

- headband for uvex pheos and uvex pheos s (see p. 45, 76)
- individual length adjustment
- metal-free



















9958023

uvex x-fit headband

- headband for uvex x-fit und uvex x-fit pro (see p. 41, 76)
- individual length adjustment
- metal-free

uvex pheos headband		uvex x-fit / uvex x-fit pro headband	
Art. no.	9958020	9958023	
Order quantity multiples	10 PC	10 PC	

Cord/case matrix

Model	Name	Cords/straps							Cases								
																	
		9958017	9958030	9958020 (pheos/ pheos s)	9959003	9959004	9959002	9958023 (x-fit family)	9954600	9954500	9954501	9954355	9954395	9954360	9954550	9954514	9957502 SECU-Box
9128	uvex pheos nxt	<input type="checkbox"/>	<input type="checkbox"/>	<input type="checkbox"/>	<input checked="" type="checkbox"/>	<input checked="" type="checkbox"/>	<input checked="" type="checkbox"/>	<input type="checkbox"/>	<input checked="" type="checkbox"/>	<input checked="" type="checkbox"/>	<input checked="" type="checkbox"/>	<input checked="" type="checkbox"/>	<input checked="" type="checkbox"/>	<input checked="" type="checkbox"/>	<input checked="" type="checkbox"/>	<input checked="" type="checkbox"/>	<input type="checkbox"/>
9134	uvex meteor	<input type="checkbox"/>	<input type="checkbox"/>	<input type="checkbox"/>	<input checked="" type="checkbox"/>	<input checked="" type="checkbox"/>	<input checked="" type="checkbox"/>	<input type="checkbox"/>	<input checked="" type="checkbox"/>	<input checked="" type="checkbox"/>	<input checked="" type="checkbox"/>	<input checked="" type="checkbox"/>	<input checked="" type="checkbox"/>	<input checked="" type="checkbox"/>	<input checked="" type="checkbox"/>	<input checked="" type="checkbox"/>	<input type="checkbox"/>
9143	uvex i-lite	<input checked="" type="checkbox"/>	<input checked="" type="checkbox"/>	<input type="checkbox"/>	<input checked="" type="checkbox"/>	<input checked="" type="checkbox"/>	<input checked="" type="checkbox"/>	<input type="checkbox"/>	<input checked="" type="checkbox"/>	<input checked="" type="checkbox"/>	<input checked="" type="checkbox"/>	<input checked="" type="checkbox"/>	<input checked="" type="checkbox"/>	<input checked="" type="checkbox"/>	<input checked="" type="checkbox"/>	<input checked="" type="checkbox"/>	<input type="checkbox"/>
9143	uvex i-guard	<input checked="" type="checkbox"/>	<input checked="" type="checkbox"/>	<input type="checkbox"/>	<input checked="" type="checkbox"/>	<input checked="" type="checkbox"/>	<input checked="" type="checkbox"/>	<input type="checkbox"/>	<input checked="" type="checkbox"/>	<input checked="" type="checkbox"/>	<input checked="" type="checkbox"/>	<input checked="" type="checkbox"/>	<input checked="" type="checkbox"/>	<input checked="" type="checkbox"/>	<input checked="" type="checkbox"/>	<input checked="" type="checkbox"/>	<input type="checkbox"/>
9143	uvex i-guard+	<input type="checkbox"/>	<input type="checkbox"/>	<input type="checkbox"/>	<input type="checkbox"/>	<input type="checkbox"/>	<input type="checkbox"/>	<input type="checkbox"/>	<input checked="" type="checkbox"/>	<input checked="" type="checkbox"/>	<input checked="" type="checkbox"/>	<input checked="" type="checkbox"/>	<input checked="" type="checkbox"/>	<input checked="" type="checkbox"/>	<input checked="" type="checkbox"/>	<input checked="" type="checkbox"/>	<input type="checkbox"/>
9145	uvex pure-fit	<input checked="" type="checkbox"/>	<input checked="" type="checkbox"/>	<input type="checkbox"/>	<input type="checkbox"/>	<input type="checkbox"/>	<input checked="" type="checkbox"/>	<input type="checkbox"/>	<input type="checkbox"/>	<input checked="" type="checkbox"/>	<input checked="" type="checkbox"/>	<input checked="" type="checkbox"/>	<input checked="" type="checkbox"/>	<input checked="" type="checkbox"/>	<input checked="" type="checkbox"/>	<input checked="" type="checkbox"/>	<input type="checkbox"/>
9159	uvex winner	<input checked="" type="checkbox"/>	<input checked="" type="checkbox"/>	<input type="checkbox"/>	<input type="checkbox"/>	<input type="checkbox"/>	<input checked="" type="checkbox"/>	<input type="checkbox"/>	<input checked="" type="checkbox"/>	<input checked="" type="checkbox"/>	<input checked="" type="checkbox"/>	<input checked="" type="checkbox"/>	<input checked="" type="checkbox"/>	<input checked="" type="checkbox"/>	<input checked="" type="checkbox"/>	<input checked="" type="checkbox"/>	<input type="checkbox"/>
9160	uvex i-vo	<input type="checkbox"/>	<input type="checkbox"/>	<input type="checkbox"/>	<input checked="" type="checkbox"/>	<input checked="" type="checkbox"/>	<input checked="" type="checkbox"/>	<input type="checkbox"/>	<input checked="" type="checkbox"/>	<input checked="" type="checkbox"/>	<input checked="" type="checkbox"/>	<input checked="" type="checkbox"/>	<input checked="" type="checkbox"/>	<input checked="" type="checkbox"/>	<input checked="" type="checkbox"/>	<input checked="" type="checkbox"/>	<input type="checkbox"/>
9161	uvex 9161	<input type="checkbox"/>	<input type="checkbox"/>	<input type="checkbox"/>	<input type="checkbox"/>	<input type="checkbox"/>	<input checked="" type="checkbox"/>	<input type="checkbox"/>	<input type="checkbox"/>	<input checked="" type="checkbox"/>	<input checked="" type="checkbox"/>	<input checked="" type="checkbox"/>	<input checked="" type="checkbox"/>	<input checked="" type="checkbox"/>	<input checked="" type="checkbox"/>	<input checked="" type="checkbox"/>	<input type="checkbox"/>
9164	uvex astrospec 2.0	<input checked="" type="checkbox"/>	<input checked="" type="checkbox"/>	<input type="checkbox"/>	<input checked="" type="checkbox"/>	<input checked="" type="checkbox"/>	<input checked="" type="checkbox"/>	<input type="checkbox"/>	<input checked="" type="checkbox"/>	<input checked="" type="checkbox"/>	<input checked="" type="checkbox"/>	<input checked="" type="checkbox"/>	<input checked="" type="checkbox"/>	<input checked="" type="checkbox"/>	<input checked="" type="checkbox"/>	<input checked="" type="checkbox"/>	<input type="checkbox"/>
9169	uvex super OTG	<input checked="" type="checkbox"/>	<input checked="" type="checkbox"/>	<input type="checkbox"/>	<input type="checkbox"/>	<input type="checkbox"/>	<input checked="" type="checkbox"/>	<input type="checkbox"/>	<input type="checkbox"/>	<input checked="" type="checkbox"/>	<input checked="" type="checkbox"/>	<input checked="" type="checkbox"/>	<input checked="" type="checkbox"/>	<input checked="" type="checkbox"/>	<input checked="" type="checkbox"/>	<input checked="" type="checkbox"/>	<input type="checkbox"/>
9169	uvex super f OTG	<input checked="" type="checkbox"/>	<input checked="" type="checkbox"/>	<input type="checkbox"/>	<input type="checkbox"/>	<input type="checkbox"/>	<input checked="" type="checkbox"/>	<input type="checkbox"/>	<input type="checkbox"/>	<input checked="" type="checkbox"/>	<input checked="" type="checkbox"/>	<input checked="" type="checkbox"/>	<input checked="" type="checkbox"/>	<input checked="" type="checkbox"/>	<input checked="" type="checkbox"/>	<input checked="" type="checkbox"/>	<input type="checkbox"/>
9172	uvex super g	<input checked="" type="checkbox"/>	<input checked="" type="checkbox"/>	<input type="checkbox"/>	<input type="checkbox"/>	<input type="checkbox"/>	<input checked="" type="checkbox"/>	<input type="checkbox"/>	<input checked="" type="checkbox"/>	<input checked="" type="checkbox"/>	<input checked="" type="checkbox"/>	<input checked="" type="checkbox"/>	<input checked="" type="checkbox"/>	<input checked="" type="checkbox"/>	<input checked="" type="checkbox"/>	<input checked="" type="checkbox"/>	<input type="checkbox"/>
9178	uvex super fit	<input checked="" type="checkbox"/>	<input checked="" type="checkbox"/>	<input type="checkbox"/>	<input type="checkbox"/>	<input type="checkbox"/>	<input checked="" type="checkbox"/>	<input type="checkbox"/>	<input checked="" type="checkbox"/>	<input checked="" type="checkbox"/>	<input checked="" type="checkbox"/>	<input checked="" type="checkbox"/>	<input checked="" type="checkbox"/>	<input checked="" type="checkbox"/>	<input checked="" type="checkbox"/>	<input checked="" type="checkbox"/>	<input type="checkbox"/>
9181	uvex suXXeed	<input checked="" type="checkbox"/>	<input checked="" type="checkbox"/>	<input type="checkbox"/>	<input type="checkbox"/>	<input type="checkbox"/>	<input checked="" type="checkbox"/>	<input type="checkbox"/>	<input checked="" type="checkbox"/>	<input checked="" type="checkbox"/>	<input checked="" type="checkbox"/>	<input checked="" type="checkbox"/>	<input checked="" type="checkbox"/>	<input checked="" type="checkbox"/>	<input checked="" type="checkbox"/>	<input checked="" type="checkbox"/>	<input type="checkbox"/>
9183	uvex i-5	<input checked="" type="checkbox"/>	<input checked="" type="checkbox"/>	<input type="checkbox"/>	<input type="checkbox"/>	<input type="checkbox"/>	<input checked="" type="checkbox"/>	<input type="checkbox"/>	<input checked="" type="checkbox"/>	<input checked="" type="checkbox"/>	<input checked="" type="checkbox"/>	<input checked="" type="checkbox"/>	<input checked="" type="checkbox"/>	<input checked="" type="checkbox"/>	<input checked="" type="checkbox"/>	<input checked="" type="checkbox"/>	<input type="checkbox"/>
9190	uvex i-3 / i-3 s	<input checked="" type="checkbox"/>	<input checked="" type="checkbox"/>	<input type="checkbox"/>	<input type="checkbox"/>	<input type="checkbox"/>	<input checked="" type="checkbox"/>	<input type="checkbox"/>	<input checked="" type="checkbox"/>	<input checked="" type="checkbox"/>	<input checked="" type="checkbox"/>	<input checked="" type="checkbox"/>	<input checked="" type="checkbox"/>	<input checked="" type="checkbox"/>	<input checked="" type="checkbox"/>	<input checked="" type="checkbox"/>	<input type="checkbox"/>
9192	uvex pheos / pheos s	<input checked="" type="checkbox"/>	<input checked="" type="checkbox"/>	<input checked="" type="checkbox"/>	<input checked="" type="checkbox"/>	<input checked="" type="checkbox"/>	<input checked="" type="checkbox"/>	<input type="checkbox"/>	<input checked="" type="checkbox"/>	<input checked="" type="checkbox"/>	<input checked="" type="checkbox"/>	<input checked="" type="checkbox"/>	<input checked="" type="checkbox"/>	<input checked="" type="checkbox"/>	<input checked="" type="checkbox"/>	<input checked="" type="checkbox"/>	<input type="checkbox"/>
9192	uvex pheos guard / s	<input type="checkbox"/>	<input type="checkbox"/>	<input checked="" type="checkbox"/>	<input type="checkbox"/>	<input type="checkbox"/>	<input type="checkbox"/>	<input type="checkbox"/>	<input checked="" type="checkbox"/>	<input checked="" type="checkbox"/>	<input checked="" type="checkbox"/>	<input checked="" type="checkbox"/>	<input checked="" type="checkbox"/>	<input checked="" type="checkbox"/>	<input checked="" type="checkbox"/>	<input checked="" type="checkbox"/>	<input type="checkbox"/>
9193	uvex sportstyle	<input checked="" type="checkbox"/>	<input checked="" type="checkbox"/>	<input type="checkbox"/>	<input type="checkbox"/>	<input type="checkbox"/>	<input checked="" type="checkbox"/>	<input type="checkbox"/>	<input checked="" type="checkbox"/>	<input checked="" type="checkbox"/>	<input checked="" type="checkbox"/>	<input checked="" type="checkbox"/>	<input checked="" type="checkbox"/>	<input checked="" type="checkbox"/>	<input checked="" type="checkbox"/>	<input checked="" type="checkbox"/>	<input type="checkbox"/>
9194	uvex i-works	<input checked="" type="checkbox"/>	<input checked="" type="checkbox"/>	<input type="checkbox"/>	<input checked="" type="checkbox"/>	<input checked="" type="checkbox"/>	<input checked="" type="checkbox"/>	<input type="checkbox"/>	<input checked="" type="checkbox"/>	<input checked="" type="checkbox"/>	<input checked="" type="checkbox"/>	<input checked="" type="checkbox"/>	<input checked="" type="checkbox"/>	<input checked="" type="checkbox"/>	<input checked="" type="checkbox"/>	<input checked="" type="checkbox"/>	<input type="checkbox"/>
9198	uvex pheos cx2	<input type="checkbox"/>	<input type="checkbox"/>	<input type="checkbox"/>	<input type="checkbox"/>	<input type="checkbox"/>	<input checked="" type="checkbox"/>	<input type="checkbox"/>	<input checked="" type="checkbox"/>	<input checked="" type="checkbox"/>	<input checked="" type="checkbox"/>	<input checked="" type="checkbox"/>	<input checked="" type="checkbox"/>	<input checked="" type="checkbox"/>	<input checked="" type="checkbox"/>	<input checked="" type="checkbox"/>	<input type="checkbox"/>
9199	uvex x-fit	<input checked="" type="checkbox"/>	<input checked="" type="checkbox"/>	<input type="checkbox"/>	<input type="checkbox"/>	<input checked="" type="checkbox"/>	<input checked="" type="checkbox"/>	<input checked="" type="checkbox"/>	<input checked="" type="checkbox"/>	<input checked="" type="checkbox"/>	<input checked="" type="checkbox"/>	<input checked="" type="checkbox"/>	<input checked="" type="checkbox"/>	<input checked="" type="checkbox"/>	<input checked="" type="checkbox"/>	<input checked="" type="checkbox"/>	<input type="checkbox"/>
9199	uvex x-fit pro	<input type="checkbox"/>	<input type="checkbox"/>	<input type="checkbox"/>	<input type="checkbox"/>	<input checked="" type="checkbox"/>	<input checked="" type="checkbox"/>	<input checked="" type="checkbox"/>	<input checked="" type="checkbox"/>	<input checked="" type="checkbox"/>	<input checked="" type="checkbox"/>	<input checked="" type="checkbox"/>	<input checked="" type="checkbox"/>	<input checked="" type="checkbox"/>	<input checked="" type="checkbox"/>	<input checked="" type="checkbox"/>	<input type="checkbox"/>
9231	uvex polavision	<input checked="" type="checkbox"/>	<input checked="" type="checkbox"/>	<input type="checkbox"/>	<input type="checkbox"/>	<input type="checkbox"/>	<input checked="" type="checkbox"/>	<input type="checkbox"/>	<input checked="" type="checkbox"/>	<input checked="" type="checkbox"/>	<input checked="" type="checkbox"/>	<input checked="" type="checkbox"/>	<input checked="" type="checkbox"/>	<input checked="" type="checkbox"/>	<input checked="" type="checkbox"/>	<input checked="" type="checkbox"/>	<input type="checkbox"/>
9301	uvex ultravision	<input type="checkbox"/>	<input type="checkbox"/>	<input type="checkbox"/>	<input type="checkbox"/>	<input type="checkbox"/>	<input type="checkbox"/>	<input type="checkbox"/>	<input type="checkbox"/>	<input type="checkbox"/>	<input checked="" type="checkbox"/>	<input type="checkbox"/>	<input type="checkbox"/>	<input checked="" type="checkbox"/>	<input type="checkbox"/>	<input type="checkbox"/>	<input checked="" type="checkbox"/>
9302	uvex ultrasonic	<input type="checkbox"/>	<input type="checkbox"/>	<input type="checkbox"/>	<input type="checkbox"/>	<input type="checkbox"/>	<input type="checkbox"/>	<input type="checkbox"/>	<input type="checkbox"/>	<input type="checkbox"/>	<input checked="" type="checkbox"/>	<input type="checkbox"/>	<input type="checkbox"/>	<input checked="" type="checkbox"/>	<input type="checkbox"/>	<input type="checkbox"/>	<input checked="" type="checkbox"/>
9305	uvex 9305	<input type="checkbox"/>	<input type="checkbox"/>	<input type="checkbox"/>	<input type="checkbox"/>	<input type="checkbox"/>	<input type="checkbox"/>	<input type="checkbox"/>	<input type="checkbox"/>	<input type="checkbox"/>	<input checked="" type="checkbox"/>	<input type="checkbox"/>	<input type="checkbox"/>	<input checked="" type="checkbox"/>	<input type="checkbox"/>	<input type="checkbox"/>	<input checked="" type="checkbox"/>
9308	uvex u-sonic	<input type="checkbox"/>	<input type="checkbox"/>	<input type="checkbox"/>	<input type="checkbox"/>	<input type="checkbox"/>	<input type="checkbox"/>	<input type="checkbox"/>	<input type="checkbox"/>	<input type="checkbox"/>	<input checked="" type="checkbox"/>	<input type="checkbox"/>	<input type="checkbox"/>	<input checked="" type="checkbox"/>	<input type="checkbox"/>	<input type="checkbox"/>	<input checked="" type="checkbox"/>
9309	uvex pheos cx2 sonic	<input type="checkbox"/>	<input type="checkbox"/>	<input type="checkbox"/>	<input type="checkbox"/>	<input type="checkbox"/>	<input type="checkbox"/>	<input type="checkbox"/>	<input checked="" type="checkbox"/>	<input checked="" type="checkbox"/>	<input checked="" type="checkbox"/>	<input checked="" type="checkbox"/>	<input checked="" type="checkbox"/>	<input checked="" type="checkbox"/>	<input checked="" type="checkbox"/>	<input checked="" type="checkbox"/>	<input type="checkbox"/>
9320	uvex megasonic	<input type="checkbox"/>	<input type="checkbox"/>	<input type="checkbox"/>	<input type="checkbox"/>	<input type="checkbox"/>	<input type="checkbox"/>	<input type="checkbox"/>	<input type="checkbox"/>	<input type="checkbox"/>	<input checked="" type="checkbox"/>	<input type="checkbox"/>	<input type="checkbox"/>	<input checked="" type="checkbox"/>	<input type="checkbox"/>	<input type="checkbox"/>	<input checked="" type="checkbox"/>
9405	uvex 9405	<input type="checkbox"/>	<input type="checkbox"/>	<input type="checkbox"/>	<input type="checkbox"/>	<input type="checkbox"/>	<input type="checkbox"/>	<input type="checkbox"/>	<input type="checkbox"/>	<input type="checkbox"/>	<input checked="" type="checkbox"/>	<input type="checkbox"/>	<input type="checkbox"/>	<input checked="" type="checkbox"/>	<input type="checkbox"/>	<input type="checkbox"/>	<input checked="" type="checkbox"/>

2 goggles or 3-4 spectacles
or 1 goggles + 2 spectacles

compatible not compatible

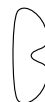

Applications

Always the perfect solution

Working conditions	Eyewear model	Lens material	Lens tint	Lens coating
Light and precision engineering	Spectacles	PC	clear	uvex supravision AR (anti-reflet) uvex supravision excellence
Assembly, maintenance	Spectacles	PC	clear	uvex supravision excellence
Grinding, angle grinding	Spectacles Goggles	PC	clear	uvex supravision excellence uvex supravision extreme
Turning, milling	Spectacles	PC	clear	uvex supravision excellence
Dusty environments	Goggles	PC	clear	uvex supravision excellence uvex supravision extreme
Foundry cleaning	Goggles	PC	clear	uvex supravision excellence uvex supravision extreme
Forestry and agriculture	Spectacles	PC	clear amber grey 23 %	uvex supravision excellence uvex supravision extreme
Laboratory	Spectacles Goggles	PC CA	clear	uvex supravision sapphire uvex supravision excellence
Working with acids and galvanic media	Goggles	PC CA	clear	uvex supravision excellence uvex supravision extreme
Mixed lighting	Spectacles	PC	clear	uvex supravision AR (anti-reflet)
Strong lighting, glare	Spectacles	PC	CBR65 silver mirror 53 %	uvex supravision excellence uvex supravision extreme
Outdoors – sunglare	Spectacles	PC	grey CBR23 silver mirror	uvex supravision excellence uvex supravision extreme
Offshoring / maritime	Spectacles	PC	variomatic polavision	uvex supravision variomatic uvex polavision
Spot welding, soldering oxygene cutting gas welding, braze welding Welders assistant foundries furnaces	Spectacles Goggles	PC	welding shade	uvex infradur uvex infradur plus
Forging Glass blowing Metal melting Working with red-hot media Working with industrial infrared drying Short-term use at a medium distance	Spectacles Overspecs	PC	Infrared protection	uvex infradur plus
Sterile working conditions	Spectacles Overspecs	PC	clear	uvex supravision CR
Oil and gas	Spectacles Overspecs Goggles	PC	clear	uvex supravision plus
Plant visitors	Spectacles Overspecs	PC	clear	uvex supravision excellence uvex supravision sapphire uncoated

Safety Eyewear

Overview

Model	Name	Product	Order quantity multiples/ Order unit	uvex supravision sapphire	uvex supravision plus	uvex supravision excellence	uvex supravision extreme	uvex supravision ETC	uvex supravision clean	uvex supravision AR	Silver mirror, inside anti-fog	uvex supravision variomatic	uvex infradur	uvex infradur plus	CA uncoated	CA anti-fog on the inside	Scratch-resistant on both sides	Scratch-resistant + anti-fog	Uncoated	Page
9128	uvex pheos nxt	Plastic safety spectacles	10 PC			■	■	■												31
9134	uvex meteor	Plastic safety spectacles	5 PC	■															■	56
9143	uvex i-lite	Plastic safety spectacles	10 PC			■														33
9143	uvex i-guard	Plastic safety spectacles	8 PC			■	■													33
9143	uvex i-guard+	Safety goggles	8 PC			■	■													33
9143	uvex i-range	Replacement lenses	15 PC			■														33
9143	uvex i-range	Headband	8 PC																	33
9145	uvex pure-fit	Plastic safety spectacles	75 PC			■													■	35
9159	uvex winner	Metal safety spectacles	5 PC														■	■		57
9160	uvex i-vo	Plastic safety spectacles	10 PC	■		■														54
9161	uvex 9161	Plastic safety spectacles	5 PC	■	■														■	57
9161	uvex 9161	Safety spectacles - welding protection	5 PC										■							71
9164	uvex astrospec 2.0	Plastic safety spectacles	10 PC	■	■	■	■													51
9164	uvex astrospec 2.0	Safety spectacles - welding protection	10 PC	■	■	■	■							■						71
9169	uvex super OTG	Plastic safety spectacles	8 PC	■		■														58
9169	uvex super f OTG	Plastic safety spectacles	8 PC	■		■														59
9169	uvex super f OTG CR	Plastic safety spectacles	8 PC						■											59
9169	uvex super f OTG	Plastic safety spectacles	PC									■								59
9169	uvex super f OTG	Plastic safety spectacles UV525	8 PC	■																59
9169	uvex super f OTG	Infrared protection spectacles	8 PC											■						69
9169	uvex super f OTG	Safety spectacles - welding protection	8 PC			■								■						72
9169	uvex super OTG/super f OTG	Replacement lenses	10 PC			■														58/59
9172	uvex super g	Plastic safety spectacles	10 PC	■	■	■														52
9172	uvex super g	Replacement lenses	20 PC			■														52
9178	uvex super fit	Plastic safety spectacles	10 PC	■	■	■		■												53
9178	uvex super fit	Replacement lenses	20 PC			■														53
9181	uvex suXxeed	Plastic safety spectacles	10 PC			■		■												37
9181	uvex suXxeed	Plastic safety spectacles	PC									■								37
9181	uvex suXxeed	Replacement lenses	20 PC			■														37
9181	uvex suXxeed	Clip-in frame	20 PC																	37
9183	uvex i-5	Plastic safety spectacles	10 PC	■		■		■												39
9183	uvex i-5	Clip-in frame	20 PC																	39
9183	uvex i-5	Safety spectacles - welding protection	10 PC											■						71
9190	uvex i-3/uvex i-3s	Plastic safety spectacles	10 PC	■	■	■				■	■									46/47
9190	uvex i-3	Plastic safety spectacles	PC							■		■								46
9190	uvex i-3/uvex i-3s	Replacement lenses	20 PC			■														46/47
9190	uvex i-3/uvex i-3s	Clip-in frame	20 PC																	46/47
9192	uvex pheos/uvex pheos CB/uvex pheos s	Plastic safety spectacles	10 PC		■	■	■	■			■									44/45
9192	uvex pheos guard/uvex pheos s guard	uvex pheos headband version	10 PC					■												45
9192	uvex pheos/uvex pheos s	Clip-in frame	20 PC																	45
9193	uvex sportstyle	Plastic safety spectacles	10 PC		■	■	■	■		■	■									42
9193	uvex sportstyle	Plastic safety spectacles	PC									■								42
9193	uvex sportstyle	Replacement lenses	20 PC				■													42

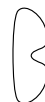

Model	Name	Product	Order quantity multiples/ Order unit	uvex supravision sapphire	uvex supravision plus	uvex supravision excellence	uvex supravision extreme	uvex supravision ETC	uvex supravision clean	uvex supravision AR	Silver mirror, inside anti-fog	uvex supravision variomatic	uvex infradur	uvex infradur plus	CA uncoated	CA anti-fog on the inside	Scratch-resistant on both sides	Scratch-resistant + anti-fog	Uncoated	Page
9194	uvex i-works	Plastic safety spectacles	10 PC			■					■									49
9194	uvex i-works	Replacement lenses	20 PC			■														49
9198	uvex pheos cx2	Plastic safety spectacles	10 PC	■		■	■	■			■									43
9198	uvex pheos cx2	Infrared protection spectacles	10 PC											■						69
9199	uvex x-fit	Plastic safety spectacles	10 PC	■		■		■												41
9199	uvex x-fit pro	Plastic safety spectacles	10 PC			■														40
9199	uvex x-fit pro (without sliders)	Plastic safety spectacles	10 PC			■														40
9199	uvex x-fit/uvex x-fit pro	Clip-in frame	20 PC																	41
9231	uvex polavision	Plastic safety spectacles	PC															■		56
9301	uvex ultravision	Safety goggles	4 PC		■	■										■				64/66
9301	uvex ultravision	Replacement lenses	30/50 PC			■										■				64/66
9300	uvex ultravision	Tear-off films	10 PC																	65
9301	uvex ultravision faceguard	Safety goggles	18 PC			■														66
9301	uvex ultravision	Mouth shield	PC																■	66
9302	uvex ultrasonic	Safety goggles	4 PC			■	■													63
9302	uvex ultrasonic CR	Safety goggles	4 PC						■											62/63
9302	uvex ultrasonic	Replacement lenses	15 PC			■	■		■											63
9302	uvex ultrasonic flip-up	Safety goggles - welding protection	4 PC			■							■							72
9302	uvex ultrasonic flip-up	Replacement lenses	15 PC										■							72
9305	uvex 9305	Safety goggles	4 PC													■				67
9308	uvex u-sonic	Safety goggles	5 PC		■	■														61
9309	uvex pheos cx2 sonic	Safety goggles	10 PC				■													61
9320	uvex megasonic	Safety goggles	4 PC			■	■	■												60
9320	uvex megasonic CR	Safety goggles	4 PC						■											60/62
9320	uvex megasonic	Safety goggles - welding protection	4 PC										■							72
9320	uvex megasonic	Replacement lenses	15 PC			■		■	■					■						60/72
9320	uvex megasonic	Headband	4 PC																	60
9405	uvex 9405	Safety goggles	4 PC													■				67
6109		RX insert astrospec 2.0	PC																	51
9972		Microfibre cloth	10 PC																	73
9954		Eyewear case	10/4 PC																	74
9954		Microfibre bag	10/4 PC																	74
9957		Display	PC																	73
9957		SECU-Box	PC																	74
9958		Neck hang cords	10 PC																	75
9958	uvex pheos/uvex pheos s	Headband	10 PC																	75
9958	uvex x-fit/x-fit pro	Headband	10 PC																	75
9959		Neck hang cord	10 PC																	75
9963		Cleaning towelettes	PC																	73
9970		Cleaning station	PC																	73
9971		Replacement cleaning papers	PC																	73
9972		Cleaning fluid	PC																	73
9973		Plastic pump	PC																	73

Innovative laser protection products

At laservision, an integral part of uvex, we protect one of the most sensitive organs from laser beams: the eye.

For more than 35 years, we have been committed worldwide to protecting eyes with customer-oriented, innovative products. Whether in industry, research and development or in the medical sector – laservision laser protection products stand for standards-compliant quality and safety.

We offer a diverse portfolio: Our eyewear, windows, curtains/blinds and screens provide optimal protection because our products are in line with the uvex safety group's DNA and motto: **protecting people.**



Laser protection for optical tables

Large area laser protection such as: curtains, blinds, screens, roll-ups

Active laser protection windows

Laser protection eyewear made of plastic, glass or with reflective coating, laser protection visors

Patient protection, magnifying glasses, IPL glasses

Laser protection windows made of glass and plastic

laservision

laservision

LASERVISION GmbH & Co. KG
 T: +49 911 9736-8100
 E: info@lvg.com
 I: uvex-laservision.de

uvexlaservision

uvex-laservision

laservision gmbh

uvexlaservision

laservision_de



You can find more information at uvex-laservision.de/en/