

uvvex

2024

protecting people

uvex

Our customers

... produce medicines, build cars, drive excavators, hike up mountains, ride bobsleighs, build bridges, renovate bathrooms, work with chemicals, take part in downhill mountain biking, cook food, do sport with the family, clean windows, lay tiles, extinguish fires, install windows, design aeroplanes, go on ski trips, dig pits, do gardening, saw wood, renovate houses, install heating, develop vaccines, operate crane systems, save lives, lay cables and pipes, perform laboratory research, work with lasers, build and operate machines, weld metals, go mountain biking, deliver parcels, lay parquet flooring, assemble photovoltaic systems, go horse riding, cycle racing bikes, go tobogganing, build ships, go skiing, jump from the highest ski jumps, lay power cables, install sockets, maintain roads, produce steel, win Tour de France stages, compete in triathlons, build tunnels, hike in the snow, put up and paint new walls, win the World Cup, manufacture tools, build roof trusses, or in a nutshell:

made2perform

Dear customers,

For almost 25 years now, the guiding principle of protecting people has been our mission and our responsibility. In order to protect people, we develop, produce and distribute products and services for sports, leisure and work. Whether on the ski slope or in the workplace: uvex reliably protects people in a wide variety of situations. We take this endeavour very seriously and want to align our brands with this clear mission statement.

Protecting people gives us a clear direction in our daily work: From product development, all the way to communication. This mission describes our self-image as a responsible company. Across all our activities, we also want to offer you significant added value in our products and services by bringing you a high level of innovation.

Sustainable action to protect people and the environment is the central basis for us to continue to be successful, together with you, in the future.



protecting people

uvex protects people
and the planet

The Board of Management, UVEX SAFETY GROUP GmbH & Co. KG

Stefan Brück

Martin Leusmann



The uvex sustainability transformation

We place the highest demands on ourselves

For uvex, sustainability is a key focus and has been for over a decade. We are aware of our responsibility and are actively engaging in the current social and technical transformation process. Our mission of **protecting people** instills in us the obligation to protect the environment. That is why uvex checks, evaluates and optimises all steps along the value creation chain so that we can continue to be at the forefront in the discipline of sustainability. We integrate sustainability holistically into our processes. We have identified four focus areas and set measurable targets throughout the Group, right down to the plant level.

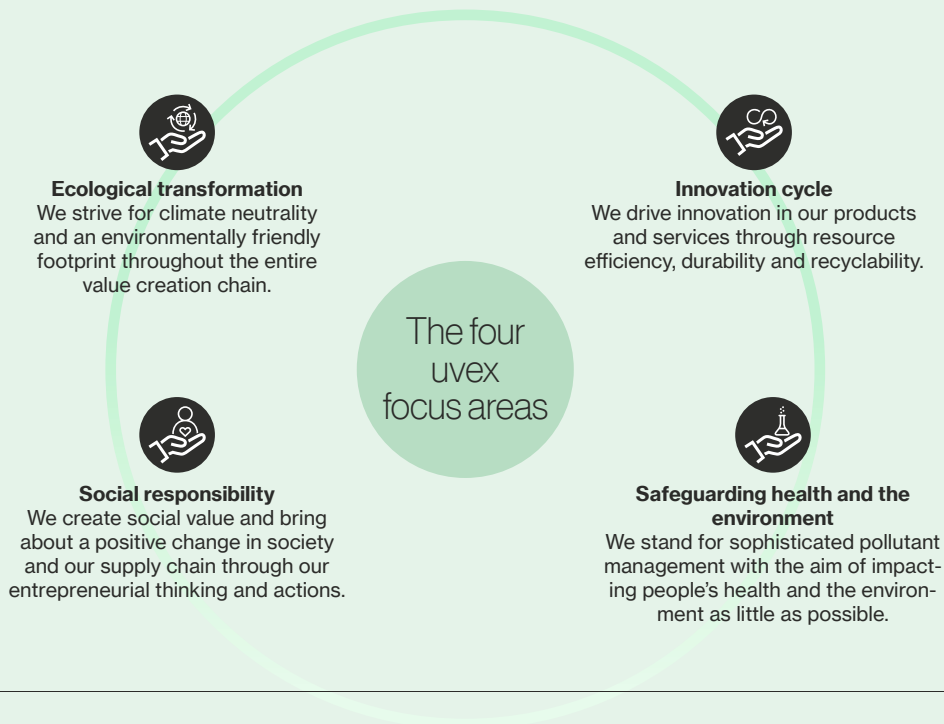

CO₂ product footprint

We ensure transparency and provide you with an indicator for the selection of more sustainable PPE

We assess the CO₂ footprint for an increasing number of products. This makes the sustainability of our products measurable, comparable and improvable. The CO₂ symbol on our products provides our customers with a clear and reliable indication of the CO₂ product footprint.



More information can be found in the online folder **uvex CO₂ product footprint**

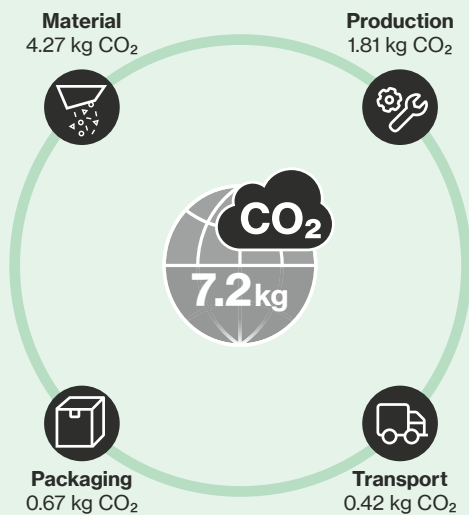

Date created: 01/2023
Example: uvex 1 G2 planet safety shoe

Emissions transparency of our products

We take into account not only the emissions from our own production steps (Scope 1 and 2), but also the emissions from the production of the materials we process (Scope 3).

made in uvex established sustainability

For uvex, the long-term sustainability measures that are widely rolled out are a matter of course

- 98.4 percent renewable energy sources since 2014
- 97.3 percent of gas consumption is CO₂ offset
- “Made in uvex”, produced at European sites (< 1,000 km radius from Fuerth)
- Packaging made mainly of waste paper
- Code of conduct



More information can be found in the online folder **uvex established sustainability**

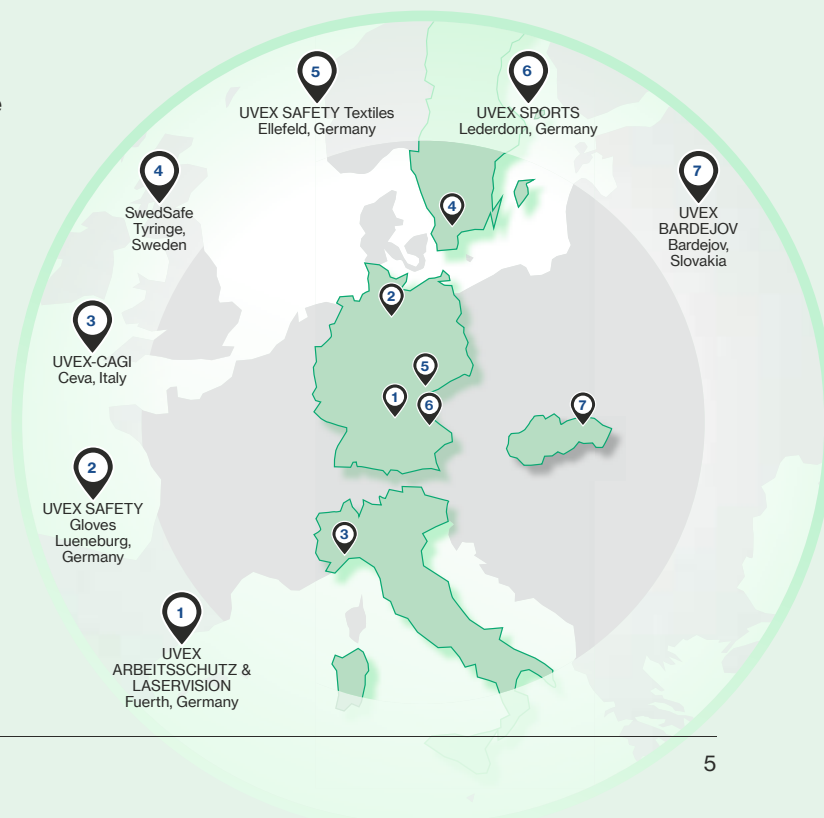

Pioneering occupational safety from uvex

The automotive industry is one of the most important economic sectors in Europe. uvex offers high-quality and innovative occupational safety solutions from head to toe: We already protect over one million employees in the automotive industry around the world with our PPE solutions.



Professional industry solutions
To learn more about our extensive range, visit uvex-safety.com/en/automotive

Production

Sales and service

The electromobility sector

Safe e-mobility with uvex PPE solutions

Electromobility is one of the key areas of activity in the automotive industry. uvex offers special occupational safety solutions, for example in the production of high-performance batteries, in order to reliably protect the production team from the dangers of high voltage or short circuit electric arcs during daily work.



uvex safety

Reliable occupational safety

- comprehensive range of solutions for the high-voltage sector and ESD workplaces
- attractive design with high wearer acceptance of the PPE
- continuous communication with customers for the development of individual PPE solutions

reliable premium partner

- decades of experience in the automotive industry
- cooperation in research and development (future projects/joint developments)
- laboratory support (glove expert system)
- technical on-site support (e.g. workplace inspections)

Want to find out more about uvex occupational safety solutions for the automotive industry?

Simply get in touch with our team of experts. Just scan the QR code.



uvex occupational safety shop
for business customers
You can find the comprehensive
range of PPE for the construction
industry at
uvex-safety.com/en/construction



All products accompanied by
this symbol are ideal for use
in the construction industry.

Safety in the construction sector

There is a range of challenges which must be faced in the construction industry, with tasks ranging from preparatory site works and civil engineering to building installation and interior fitting. To achieve optimal results, everyone involved must work in flawless synergy with each other – as must all items of personal protective equipment.



uvex has developed and selected over 150 innovative PPE products for the construction industry, all of which are designed to meet the specific needs of the sector. With over 12 product categories, the uvex profisystem construction covers all areas of application optimally and has a professional solution for every use – from head to toe. Our occupational safety experts understand the needs of the construction industry, and can provide expert advice to help you select the right PPE.



uvex
+
HexArmor

Strong team

Since 2016 **uvex** and **HexArmor** have been working together with innovative protective equipment to ensure trust, safety and reliable protection for people.

uvex fire & rescue

PPE/protective equipment for fire departments.

Our innovative PPE solutions, which we have developed in cooperation with fire departments, offer optimal safety to those working in the emergency services. For technical rescue and reliable post fire gross decontamination: Our practical and comprehensive product systems are ideal for the requirements of everyday life in the fire brigade – and meet all standards and specifications.



Further information at:
uvex-safety.com/en/fire-and-rescue

Technical rescue

Whether it's a technical emergency rescue, securing and lifting loads or emergency door opening: The uvex product system for technical rescue protects emergency services during all technical operations – and can be perfectly combined with firefighter protective clothing.

Post fire gross decontamination

After fighting a fire, consistent and effective post fire gross decontamination is essential: Our sophisticated product system protects against hazardous fire residues on the equipment.

Safety gloves



HexArmor® helix 3007
› page 272



uvex u-fit ft
› page 259

Hearing protection

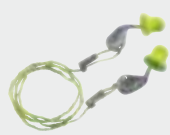

uvex xact-fit
› page 92

Complete sets uvex Firefighter Decon Kit*



Fire Crew Support Crew

uvex firefighter changing overalls



Inner and outer

Safety eyewear



uvex pheos cx2
› page 41



uvex megasonic
› page 58

Respiratory protection



uvex silv-Air 3210
› page 176

Accessories



uvex under-helmet cap
› page 132

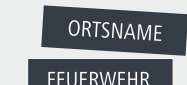

back patches

For professional use – eye protection for special forces

Special forces rely on first-class equipment for their operations all around the world, which gives them a crucial advantage. This includes particularly effective eye protection, guaranteed to be absolutely distortion-free and can adapt to any situation.

uvex apache safety spectacles boast maximum robustness, a modern, sporty design and optimal wearer comfort – and come in a set with a case as well as replacement lenses in orange and UV protection grey.



uvex apache spec

The lightweight safety spectacles with slim arm geometry boast the perfect fit and permanent anti-fog coating for continually clear vision.



uvex apache goggle

The sturdy goggles with flame-retardant headband and permanent anti-fog coating offers reliable protection.



uvex apache sets

uvex apache safety spectacles come in a set with a **case and replacement lenses** in orange and UV protection grey.



Further information at:
uvex-safety.com/en/products/safety-glasses-for-special-forces/



E-procurement –
faster processing, lower costs.

Digital ordering processes (e-procurement) simplify purchasing processes, save time and reduce costs.

Take advantage of e-procurement with uvex:

- via e-procurement software, e.g. SAP Ariba or Onventis
- via e-marketplaces such as Mercateo and Simple System
- via direct connection of ERP systems such as SAP and Navision
- or simply via the uvex online shop

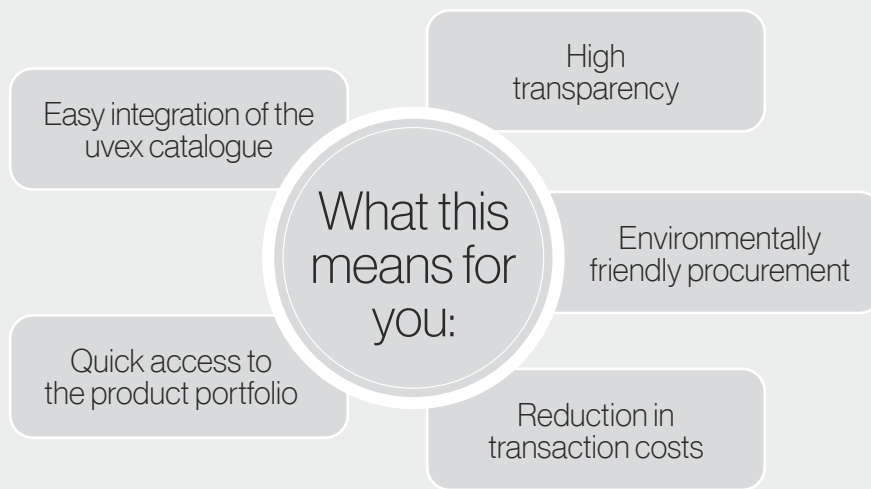

We supply electronic catalogues

- Static:
- BMECat 1.2 & 2005
 - Ariba cif-cat
 - Coupa csv-cat
 - eCat csv
 - Ariba xlsx-cat
- Dynamic:
- OCI\d
 - Punchout levels 1 & 2

With the common classification systems

- eClass
- UNSPSC
- eTIM

Receive the following messages via EDI

- Orders
- Order confirmations
- Delivery advice
- Invoice

Via the following EDI communication channels

- SMTP
- HTTPS/HTTP
- FTP/SFTP
- OFTP
- X.400
- AS2

In all common EDI message formats

- EDIFACT
- OpenTRANS
- xCML
- IDOC
- XML & cXML
- CSV
- VDA
- xCBL
- ASCII



Further information at:
uvex-safety.com/e-procurement

For your success in e-commerce –
uvex offers optimal solutions for your digital sales channels.

Take advantage of our comprehensive electronic services:



Further information at:
[uvex-safety.com/
dealer-service](http://uvex-safety.com/dealer-service)

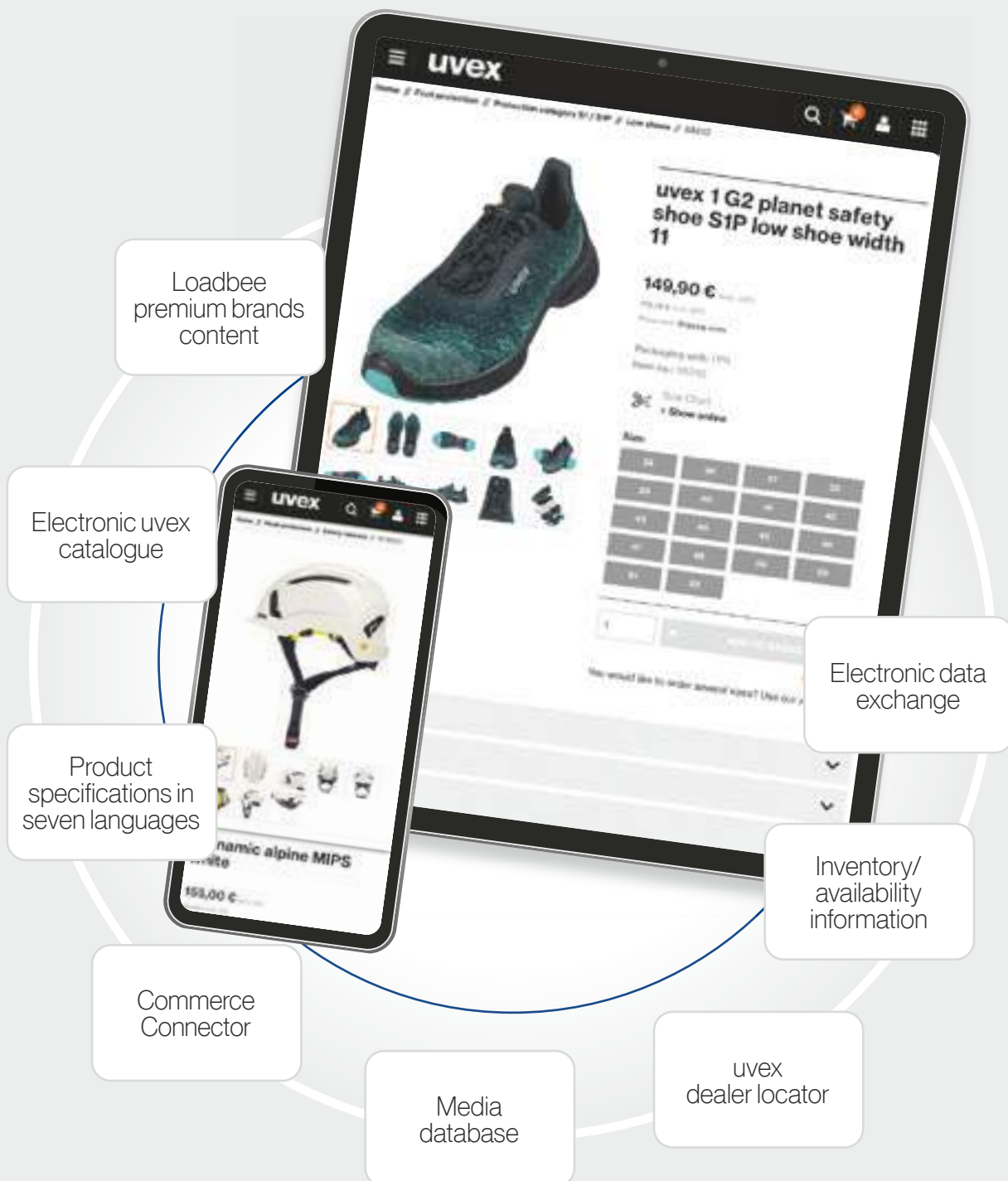

uvex safety + uvex sports

One brand. One mission.

uvex products protect people at work, in sport and for leisure. As a partner of international top-level sport, uvex equips over 1000 professional athletes worldwide, e.g. with ski goggles, equestrian riding helmets and cycling helmets.



The transfer of knowledge between uvex safety and uvex sports makes our products even safer, more functional and more comfortable – both product divisions benefit mutually from the collaboration.

This is evident in our supravision coating technology, for example, which is used equally by both uvex safety and uvex sports. This unique coating ensures maximum antifogging properties on sports goggles and safety spectacles, enabling the wearer to put in their very best performance at work or at play.



Further information at:
uvex-sports.com





Safety Eyewear

Product system planet series › Safety Eyewear

uvex has developed the **protecting planet** icon, to help raise awareness of its commitment to achieving increased sustainability. Based on the brand claim, **protecting people**, our sustainable approach integrates three core interlinked pillars – **ecology, economy** and **social responsibility**, that are incorporated throughout the business to improve our sustainability performance.

This explains the comprehensive audit, measurement and evaluation management process uvex undertakes along the entire value chain to ensure its products are as sustainable as possible.

uvex pheos nxt planet

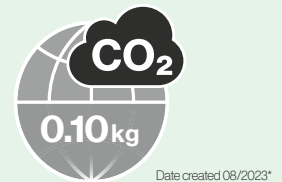

MADE IN GERMANY

 **protecting planet**
by using recycled material

- Side arms**
- › hard component made from 32.5 percent recycled material
 - › soft component made from 47.4 percent recycled material, using waste from the recycling bin

- Lens**
- › 100 percent mass-balanced polycarbonate**

 **protecting planet**
by using environmentally-friendly packaging

- Films of polyester bags**
- › up to 70 percent recycled material from production waste

- Cartons**
- › made of over 90 percent recycled paper

Lens
100%
 mass-balanced** PC

Hard components of
 side arms
32.5%
 from recycled material



9128295

Soft components of
 side arms
47.4%
 from post-consumer recycled material
 (PCR)



protecting planet

by reducing waste

Paper for instruction manuals

› 60 percent reduction

Packaging units

› increase from 5 to 10 pairs of spectacles reduces packaging material and causes less waste

** Mass-balanced products are products whose production has been **proven** to use bio-based raw materials or primary products **within a specified scope** and **without** biogenic carbon being **reliably detectable in the final product**. Mass balancing is a bookkeeping method (e.g. for the proportion of recycled materials) for recording and tracking the mass flows of plastics along the entire value creation chain. In this process, fossil-based raw materials are replaced during production, for example through the replacement of CO₂, biomass or secondary raw materials from chemical recycling. Since the mass-balanced approach is a bookkeeping method, the exact proportion of recycled materials in the product cannot be determined exactly.

The uvex brand is our responsibility

We have been producing and selling high-quality products for the protection of people in sport, leisure and work for **over 90 years**. And if you want to protect people, **you have to take responsibility**.

It is precisely from this mission that our obligation derives to act in a **sustainable, social and socially-responsible** manner.

uvex eye protection

Sustainability without compromising quality

In the PPE sector, the use of recycled or bio-based materials must not impair the protective properties under any circumstances – this makes the search for and use of sustainable materials a major challenge.

Nevertheless, we have succeeded in qualifying suitable recycled and bio-based (and, in some cases, mass-balanced**) materials, which can be processed and used in the manufacture of some of our top sellers:

Lenses
mass-balanced PC made from bio-based raw materials

Side arms
recycled or bio-based material and PCR¹

Frame
recycled PET bottles or bio-based material³ as well as PCR¹ and PIR²

Coupling parts and headband hooks
recycled PET bottles

Soft face seal
recycled granulate

Headband
recycled yarn, bio-based material³ (headband slider)

The proportion of recycled, bio-based material varies from model to model, but always lies between

13.0% and **71.5%**

This enables CO2 savings of

26.0% up to **55.0%**

Expanded range of replacement lenses

Conserving resources, reducing waste
Instead of disposing of all parts of the safety eyewear, we make it easy to replace the lens so that the frame can be used for longer. This enables us to save material and energy in production and contributes to sustainability and waste prevention.

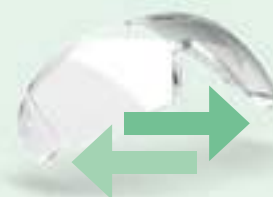

Material and weight savings by using replacement lenses:

for spectacles,
up to **-44%**

for goggles,
up to **-82%**



Emissions transparency of our products

We take into account not only the emissions from our own production steps (Scope 1 and 2), but also the emissions from the production of the materials we use (Scope 3). The carbon footprint is the result of an emissions calculation of all greenhouse gases released by an activity. The effect that various greenhouse gases have on the climate is expressed in CO₂ equivalents (kg CO₂ eq)

Innovative safety eyewear — made in Germany

uvex eye protection centre of expertise

Innovative safety eyewear for the highest quality standards

In Fürth, Bavaria, uvex develops and produces first-class and highly functional safety spectacles, goggles, prescription spectacles and laser protection eyewear. The uvex plant is certified in accordance with ISO 9001:2015 and ISO 50001:2011, and relies on state-of-the-art technology and strategic partnerships to develop future-oriented technologies and products.



uvex safety eyewear greatly exceeds all requirements of the applicable standards.
Because good is not good enough for us.

Perfection as standard from uvex

All safety eyewear is comprehensively tested at the uvex test centre: As well as satisfying national and international safety standards, every item of safety eyewear also meets the exacting uvex standard in terms of functionality, ergonomics, durability and wearer comfort.

Innovative coating technologies are one of uvex's core competencies. The improved uvex supravision excellence universal coating exceeds the anti-fogging requirements of the EN 168 standard four times over.

New uvex product and innovation highlights



The product highlight:
With its great design, lightness and fit, the uvex pheos nxt is the perfect addition to our pheos family.



The innovation highlight:
With uvex IR-ex, uvex is offering safety eyewear with IR protection filters for the first time. The special feature of the filter is that it meets the requirements of multiple standards.

You can find more information about our new products on pages 14/15, 28/29 and 66/67.

Perfect vision for maximum safety

uvex coating expertise

It all comes down to the coating

Looking through lenses that are fogged up, scratched or dirty significantly increases the risk of accidents during the working day. uvex has been synonymous with innovative coating technologies for decades: In our centre of expertise in Fürth, we develop and produce scratch-resistant and anti-fog lenses for a multitude of applications.



The innovative coating technology makes uvex safety eyewear a reliable companion during day-to-day work — in a variety of applications.

Innovative manufacturing process

Conventional safety eyewear combines anti-fogging properties and scratch-resistance on both sides of the lens: This reduces the scratch-resistance and the anti-fogging effect is lessened by regular cleaning. Unlike conventional processes, the unique uvex process applies different coatings to either side of the lens.

Perfect vision whatever the situation

The outside of uvex lenses has an extremely scratch-resistant, chemical-resistant and easy-to-clean coating, while the inside is coated with a highly durable anti-fog effect — for perfect vision and maximum safety. Lenses are also available with an extremely scratch-resistant or anti-fog coating on both sides — depending on the working environment.

uvex supravision excellence — next level performance

uvex has further improved its proven uvex supravision excellence coating technology once again: All lenses now offer twice the performance in terms of anti-fogging time, exceeding the requirements of the EN 168 standard four times over.

dry 0% RH



uvex supravision excellence

Interior	Performance	Exterior
▲▲▲▲	Anti-fog	△△△△
▲▲▲△	Scratch-resistance	▲▲▲▲

- Unique dual-action permanent anti-fog coating on the interior of the lens and a scratch-resistant hard coating on the exterior. This allows each coating to perform at maximum efficiency.
- extremely scratch-resistant and chemical-resistant on the outside of the lens with non-stick, easy to clean technology
- long lasting anti-fog performance on the inside
- anti-fog performance will not diminish even after repeated cleaning
- suitable for a wide range of workplaces

cold -20 °C



uvex supravision plus

Interior	Performance	Exterior
▲▲▲▲	Anti-fog	▲▲▲▲
▲▲▲△	Scratch-resistance	▲▲▲△

- long lasting anti-fog performance and scratch-resistance on both sides
- anti-fog performance will not diminish even after repeated cleaning
- suitable for environments where there is high humidity and/or frequent temperature fluctuations

Find your ideal lens coating

1. Select the **temperature** which best represents your working environment on the **horizontal temperature axis**.
2. Define the **air humidity** of your environment in percentage terms and find the value on the **diagonal axis**.
3. Determine the **level of dirt** on the **vertical axis**.
4. Connect these three points to form a triangle.
5. The part of the triangle with the **largest area** indicates the lens coating most suited for your workplace.



scan for QR-Code for further information.
uvex-safety.com/en/antifog



Coating technology

Core Coatings

dirty

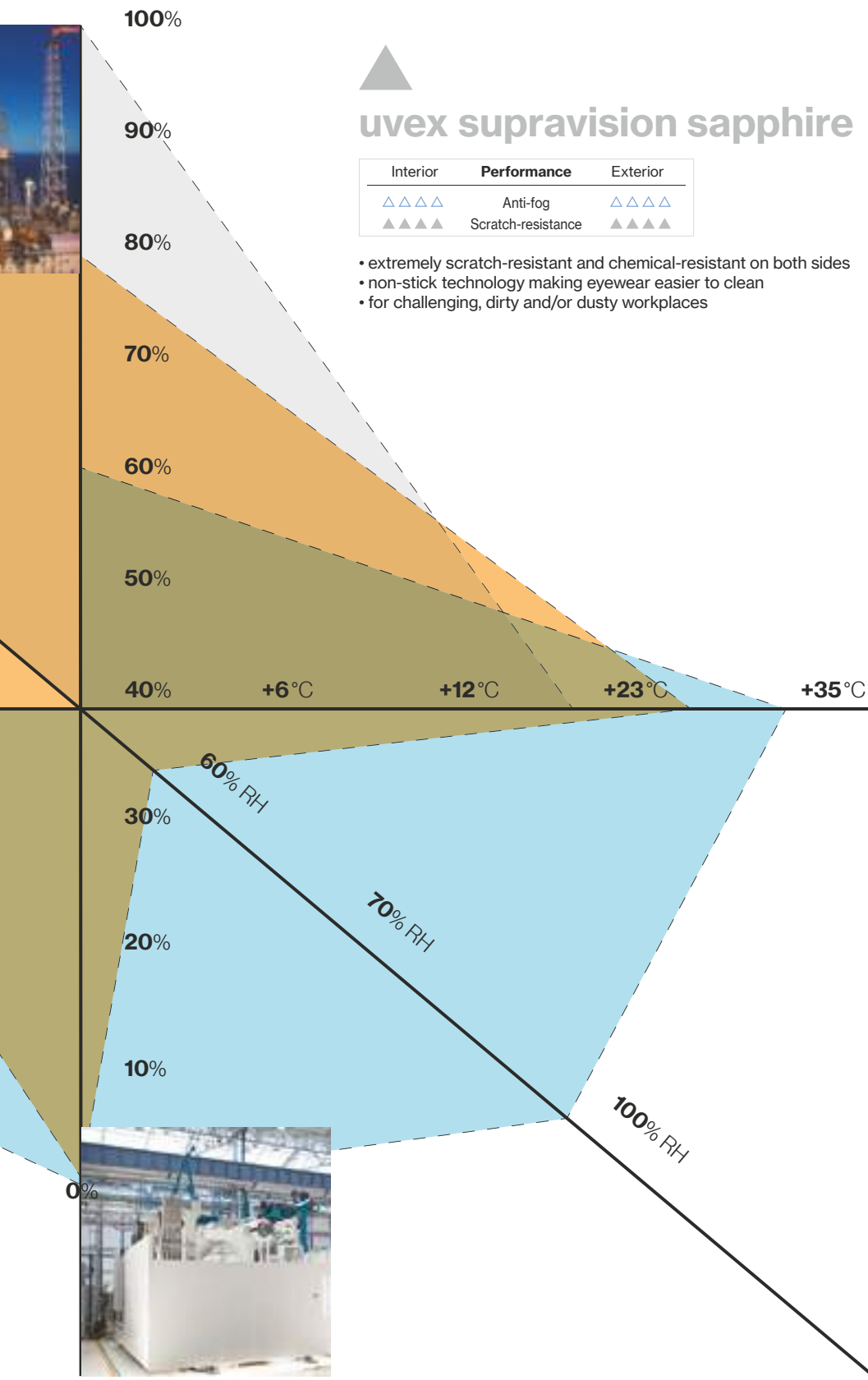

uvex supravision sapphire

Interior	Performance	Exterior
△△△△	Anti-fog	△△△△
▲▲▲▲	Scratch-resistance	▲▲▲▲

- extremely scratch-resistant and chemical-resistant on both sides
- non-stick technology making eyewear easier to clean
- for challenging, dirty and/or dusty workplaces



hot +35°C



clean



wet 100% RH

Coating technology

Special Coatings



scan for QR-Code
for further information
uvex-safety.com/en/antifog

uvex supravision extreme

Interior	Performance	Exterior
▲▲▲▲	Anti-fog	△△△△
▲▲▲△	Scratch-resistance	▲▲▲▲

Interior:

- durable, permanent anti-fog performance
- coating forms a thin veil of water without impairing vision

Exterior:

- extremely scratch-resistant, chemical-resistant and easy to clean

Areas of application:

- prolonged exposure to high risk of fogging and dirt

uvex supravision ETC (extreme temperature conditions)

Interior	Performance	Exterior
▲▲▲▲	Anti-fog	▲▲▲▲
▲▲▲△	Scratch-resistance	▲▲▲△

Interior and exterior:

- durable, permanent anti-fog performance
- coating forms a thin veil of water in humid environments without impairing vision

Areas of application:

- workplaces with high humidity and/or frequent temperature fluctuations

uvex supravision clean

Interior	Performance	Exterior
▲▲▲△	Anti-fog	△△△△
▲▲▲△	Scratch-resistance	▲▲▲▲

Specifically developed for the health care sector. Lenses with uvex supravision clean are autoclavable.

Interior:

- lasting anti-fog performance
- anti-fog performance lasts a minimum of 20 autoclave cycles

Exterior:

- extremely scratch-resistant, chemical-resistant and easy to clean

Areas of application:

- dry, clean environments

uvex supravision variomatic

Interior	Performance	Exterior
▲▲▲▲	Anti-fog	△△△△
▲▲▲△	Scratch-resistance	▲▲▲▲

Self-tinting coating that darkens when exposed to UV. Benefits from highly effective anti-fog performance inside, extremely scratch-resistant on the outside.

Self-tinting coating:

- automatically darkens within 10 sec. and lightens within 30 sec.

Areas of application:

- frequent moves between indoor and outdoor environments or light and dark workspaces

uvex supravision infradur

Interior	Performance	Exterior
△△△△	Anti-fog	△△△△
▲▲▲▲	Scratch-resistance	▲▲▲▲

Specifically developed for welding applications. Extremely high scratch-resistance on both sides. Minimises burns from welding sparks.

Areas of application:

- suitable for very dirty, dry welding applications where there is minimal risk of fogging

uvex supravision infradur plus

Interior	Performance	Exterior
▲▲▲▲	Anti-fog	△△△△
▲▲▲△	Scratch-resistance	▲▲▲▲

Specifically developed for welding applications. Lasting anti-fog performance on the inside, extremely scratch-resistant outside and minimises burns from welding sparks.

Areas of application:

- suitable for dirty, welding environments with a high possibility of fogging



Marking and standards

Marking on lenses in accordance with EN 166

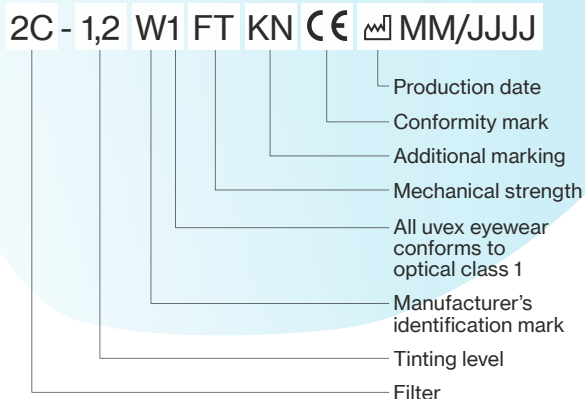

Filter

2	UV protection filter (EN 170)
2C/3	UV protection filter with colour recognition (EN 170)
4	IR protection filter (EN 171)
4C	IR protection filter with colour recognition (EN 171)
5	Sunglare filter for industrial use (EN 172)
6	Sunglare filter with infrared requirement

Tinting levels

AR	1.2 (Light transmittance 74.4–100%)
clear	1.2 (Light transmittance 74.4–100%)
amber	1.2 (Light transmittance 74.4–100%)
CBR65	1.4 (Light transmittance 58.1–80%)
silver mirror 53%	1.7 (Light transmittance 43.2–58.1%)
CBR23	2.5 (Light transmittance 17.8–29.1%)
grey 23%	2.5 (Light transmittance 17.8–29.1%)
polavision	3.1 (Light transmittance 8–17.8%)
grey 12%	3.1 (Light transmittance 8–17.8%)
silver mirror 12%	3.1 (Light transmittance 8–17.8%)

Mechanical strength

none	Minimum robustness (filters only)
S	Increased robustness
F	Low-energy impact (45m/s or 162 km/h)
B	Medium-energy impact (120m/s or 432 km/h)
A	High-energy impact (190m/s or 684 km/h)
T	Tested under extreme temperatures (-5°C/+55°C)

Additional markings

K	Surface resistance to damage by small particles in accordance with EN 168 (scratch-resistance)
N	Resistance to fogging in accordance with EN 168
8	Protection against short-circuit electric arc
9	Protection against molten metal and hot solids

Marking on frame in accordance with EN 166

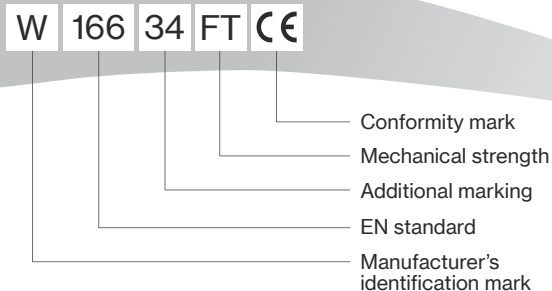

Additional markings

none	General use
3	Protection against liquids (drops and splashes)
4	Protection against large dust particles with a grain size of > 5 µm
5	Protection against gases, vapours, smoke, fumes and fine dust particles with a grain size of < 5µm
8	Protection against short-circuit electric arc
9	Protection against molten metal and hot solids

Mechanical strength

none	Minimum robustness (filters only)
S	Increased robustness
F	Low-energy impact (45m/s or 162 km/h)
B	Medium-energy impact (120m/s or 432 km/h)
A	High-energy impact (190m/s or 684 km/h)
T	Tested under extreme temperatures (-5°C/+55°C)



Lens tinting

A lens solution for every light environment



CLEAR

Protection: UV400
 UV/markings: 2(C)-1.2
 Transmission: approx. 91%
 Standards: EN 166, EN 170

Protection against **mechanical hazards** without **glare**



AMBER

Protection: UV400
 UV/markings: 2(C)-1.2
 Transmission: approx. 88%
 Standards: EN 166, EN 170

Protection against **mechanical hazards** without **glare**, with **contrast enhancement**



CBR65

Protection: UV400
 Marking: 5-1.4
 Transmission: approx. 65%
 Standards: EN 166, EN 172

Protection **offering relaxing, focused vision**

► uvex i-5 (p. 37), uvex sportstyle (p. 40), uvex pheos cx2 (p. 41), uvex super f OTG (p. 57), uvex pheos cx2 sonic (p. 59)



AR (anti-reflective)

Protection: UV400
 UV/markings: 2(C)-1.2
 Transmission: approx. 96.5%
 Standards: EN 166, EN 170

Optimum **anti-reflective** protection with high degree of light transmission

► uvex sportstyle (p. 40), uvex i-3 (S. 44)

tint with glare protection not necessary ←



74–100% transmission



58–80% transmission

Lens tinting



CBR23

Protection: UV400
 Marking: 5-2.5
 Transmission: approx. 23%
 Standards: EN 166, EN 172

Protection against **natural glare** with **signal colour recognition** and **increased contrast effect**

► uvex pheos nxt (p. 29), uvex i-5 (p. 37), uvex sportstyle (p. 40), uvex pheos cx2 (p. 41), uvex megasonic (p. 58)



POLAVISION

Protection: UV400
 Marking: 5-3.1
 Transmission: approx. 14%
 Standards: EN 166, EN 172

Reduction of irritating surface reflection by **filtering scattered light**

► uvex polavision (p. 54)

tint with contrast adjustment recommended



SILVER MIRROR 53%

Protection: UV400
 Marking: 5-1.7
 Transmission: approx. 53%
 Standards: EN 166, EN 172

Protection in **changing light conditions**

► uvex pheos (p. 42), uvex i-works (p. 47)



SILVER MIRROR 12%

Protection: UV400
 Marking: 5-3.1
 Transmission: approx. 12%
 Standards: EN 166, EN 172

Protection from both highly **artificial light and natural glare conditions**

► uvex sportstyle (p. 40), uvex pheos cx2 (p. 41), uvex i-3 (p. 44)

tint with contrast adjustment not necessary



GREY 23%

Protection: UV400
 Marking: 5-2.5
 Transmission: approx. 23%
 Standards: EN 166, EN 172

Protection against **natural glare** with **signal colour recognition**

► uvex pheos cx2 (p. 41)



GREY 12%

Protection: UV400
 Marking: 5-3.1
 Transmission: approx. 12%
 Standards: EN 166, EN 172

Protection against **natural glare** with **signal colour recognition**

► uvex pheos cx2 (p. 41)

tint with glare protection recommended

tint with glare protection recommended



uvex UV400

100% UV protection. 100% safety. 100% uvex.

The EN166/170 standard requires safety eyewear to provide UV protection up to 380 nm. The latest scientific findings show that this is not enough. The WHO (World Health Organization) recommends UV protection up to 400 nm.



“The reasons why the WHO recommends UV400 protection are clear. The outer tissues of the eye, cornea and lens fully absorb UV light. While UVB light primarily damages the genetic material, UVA rays penetrate deeper, cause thermal damage and magnify the effects of UVB light.”

Univ.-Prof. Dr. rer. nat. Olaf Strauß



uvex UV400 – included in all uvex safety eyewear

Whether you choose clear or tinted lenses, all uvex safety spectacles are equipped with uvex UV400 effective UV protection as standard – as well as pleasant wearer comfort, a sporty design and top-quality lens coatings.

Even without sun, UV rays can still put strain on the eye

When working outdoors, your eyes are regularly exposed to harmful UV radiation – even when it is cloudy. The result: using insufficient protection risks may cause dangerous long-term damage such as corneal injury, cataracts and blindness.

100% protection against dangerous UVA and UVB radiation

For the eye and surrounding skin

Radiation in nm

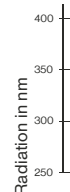

uvex UV400 offers complete protection against UVA and UVB radiation as well as high-energy visible light (HEV) up to a wavelength 400 nm.

uvex UV400 not only filters 100% of UVA rays (20% still passes through 380 nm lenses), it also completely minimises temperature-induced cell changes – a factor which increases tenfold in the percentage of total cell damage in the range from 380 to 400 nm. In addition, the dangerous, damaging blue light content (HEV), which is also harmful to the retina, is reduced by 15%.

uvex safety eyewear,
100% safety.



uvex CBR65 · uvex CBR23

Fatigue-free, comfortable vision

Preventive protection against blue light

The properties of the uvex CBR65 and CBR23 lens technology are significantly different to those of uvex UV400. They filter high-energy visible light (HEV) – which causes particular strain on the retina in the range from 380 nm to 450 nm – by up to 50 or 95%.

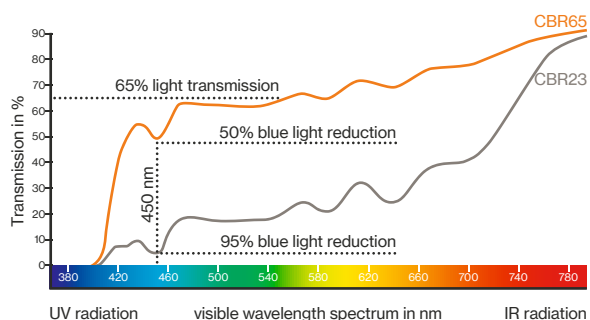

Strain on the eye caused by blue light has increased enormously as a result of intensive use of electronic devices (PCs, smartphones, tablets, LED TVs etc.) and the switch from incandescent light bulbs to LEDs. The short-term effects of this include eye strain, headaches and poor concentration, while in the long term there is an increased risk of age-related macular degeneration. uvex CBR65 and CBR23 reliably protect the eye against health risks without disrupting the body's internal clock.

Contrast

Contrast enhancement

Better contrast for clearer vision, helping to reduce strain on the eyes – even in diffused light.

Bluelight reduction

Blue light reduction

Blue light is reduced by up to 50 or 95%.

Relaxed vision

Relaxed vision

Ideal for high-concentration work; the eyes get less tired even when working for longer periods.

65% transmission

Slight tint

Ideal for use both indoors and outdoors. Ideal for working in bright LED lights, for example.

23% transmission

Optimal protection against glare

Especially for working outdoors.



9183064



9193064



9128223



9183223



9169164



9198064



9193223



9198223



9309064



9320223



For more information, visit uvex-safety.com/en/product-group/uvex-cbr65/

uvex



grip. fit. vented.

uvex pheos nxt

The uvex pheos nxt combines a classic sporty design with comfort, lightness and optimum protection.

The special design of the arms is not just visually impressive: the directional structure ensures extremely good grip – even for demanding work.

Numerous cut-outs in the side arms improve air circulation and make the spectacles lightweight without sacrificing strength.

In addition, the large panoramic lens offers a wide, distortion-free field of vision to provide a clear, comfortable view.

The uvex pheos nxt is an appealing all-rounder and ideal companion for a wide range of working conditions.

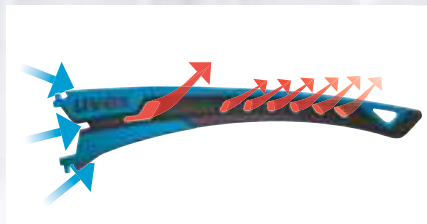

The innovative side arm design allows **maximum air circulation** for climate-optimised wearer comfort.



The **grip structure** guarantees a secure fit even during demanding work.



The proven **uvex supravision coating technology** (with UV400 protection) offers a distortion-free field of view at all times.



Lightweight design for an even more comfortable fit.



Safety Spectacles

uvex pheos nxt · uvex pheos nxt planet



9128265



9128223



9128295

More information on the sustainable uvex pheos nxt planet on page 14/15

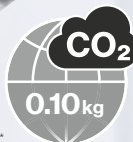

Date created 08/2023*

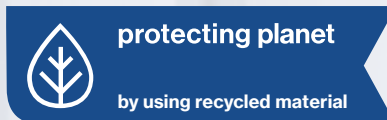

uvex pheos nxt

- classic sporty, lightweight safety spectacle with innovative side arm structure for optimal, secure hold at all times
- ergonomically shaped side arms with grip structure and soft-grip temple ends provide a comfortable, secure fit without pressure
- numerous recesses in the side arms provide increased air circulation for excellent climate-optimised wearer comfort
- nose bridge designed for all-day comfort
- robust polycarbonate lens with uvex's proven supravision coating technology – permanent anti-fog and scratch-resistant lens
- UV400 – 100% protection against dangerous UV radiation up to 400 nm
- metal-free



For more information, visit uvex-safety.com/pheosnxt

uvex pheos nxt	uvex pheos nxt planet	9128223	
Art. no.	9128265	9128295	9128223
Version	uvex supravision excellence	uvex supravision excellence	uvex supravision excellence sunglare filter
Standard Frame	EN 166, EN 170 blue, anthracite W 166 FT CE	EN 166, EN 170 anthracite, jade W 166 FT CE	EN 166, EN 172 white, black W 166 FT CE
Lens	PC clear UV400 2C-1.2 W1 FTKN CE	PC clear (mass balanced) UV400 2C-1.2 W1 FTKN CE	PC CBR23 UV400 5-2.5 W1 FTKN CE
Weight	25 g	25 g	25 g
Order quantity multiples	10 PC	10 PC	10 PC

MADE IN GERMANY

uvex

sustainable. flexible. safe.



uvex i-guard

additional protection against liquids, particles and dirt thanks to the highly flexible frame that adapts to any face shape without pressure (marking 3 and 4 in accordance with EN 166)



uvex i-lite

impressive modern design with flat lens geometry



uvex i-guard+

goggles with headband go above and beyond the minimum requirements and boast increased mechanical strength



uvex i-range



reddot winner 2022

The uvex i-range is our new flexible 3in1 safety eyewear range that allows wearers to select the right product for the workplace hazard or environment.



x-tended sideshield
for additional side protection



Flat lens design
for an unrestricted field of vision



With proven **uvex supervision coating technology** and UV400 protection



protecting planet

by using recycled material // by using bio-based material

Made of recycled and bio-based materials to conserve resources and protect the environment



Ergonomically shaped side arms for a perfect fit and secure hold without creating pressure points



Three-stage adjustable side arms for individual customisation



Soft and flexible face seal made from sustainable materials for a universal fit



uvex i-guard+ kit can be specifically adjusted to any application thanks to the flexibility to swap the side arms and headband



Safety Spectacles

uvex i-range · uvex i-range planet

uvex i-range planet
sustainably manufactured models
made from recycled, bio-based
material



9143295



9143296



9143297



9143265



9143266



9143267



9143281



9143282



9143283

uvex i-range

- versatile 3in1 safety eyewear range – allows eyewear to be adapted according to workplace hazards
- large, flat lens delivers unrestricted field of vision
- x-tended sideshield offers additional protection from hazards
- side arms with multi-incline points allow for a high level of individualisation to ensure a good fit for all facial shapes and head widths
- ergonomically shaped side arms provide a secure fit without pressure
- robust polycarbonate lens with uvex's proven supravision coating technology – permanent anti-fog and scratch-resistant lens

- UV400 – 100 % protection against dangerous UV radiation up to 400 nm
- nachhaltiger Vorteil: Scheiben und Kopfbänder können bei Bedarf ausgetauscht werden
- metal-free
- uvex i-guard: soft, flexible face seal adapts to the wearer providing both protection and comfort. It also protects against droplets or splashes of liquids and large dust particles (markings 3 and 4)
- uvex i-guard+: above features together with increased impact protection
- uvex i-guard+ kit: interchangeable side arms and headband means eyewear can be worn as a spectacle or goggle depending on the workplace hazards



red dot winner 2022



For more information, visit
uvex-safety.com/en/irange

uvex i-range	uvex i-lite	uvex i-lite planet	uvex i-lite	uvex i-guard	uvex i-guard planet	uvex i-guard
Art. no.	9143265	9143295	9143281	9143266	9143296	9143282
Replacement lens	9143255	-	-	9143255	-	-
Version	uvex supravision excellence	uvex supravision excellence	uvex supravision excellence	uvex supravision excellence	uvex supravision excellence	uvex supravision excellence
Standard	EN 166, EN 170	EN 166, EN 170	EN 166, EN 172	EN 166, EN 170	EN 166, EN 170	EN 166, EN 172
Frame	anthracite, blue	anthracite, jade	anthracite, lime	anthracite, blue	anthracite, jade	anthracite, lime
	W 166 F CE	W 166 F CE	W 166 F CE	W 166 34 F CE	W 166 34 F CE	W 166 34 F CE
Lens	PC clear	PC clear	PC grey 23%	PC clear	PC clear	PC grey 23%
	UV400	UV400	UV400	UV400	UV400	UV400
	2C-1.2 W1 FKN CE	2C-1.2 W1 FKN CE	5-2.5 W1 FKN CE	2C-1.2 W1 FKN CE	2C-1.2 W1 FKN CE	5-2.5 W1 FKN CE
Weight	32 g	32 g	32 g	48 g	48 g	48 g
Order quantity multiples	10 PC	10 PC	10 PC	8 PC	8 PC	8 PC

uvex i-range	uvex i-guard+	uvex i-guard+ planet	uvex i-guard+	uvex i-guard+ kit
Art. no.	9143267	9143297	9143283	9143300
Replacement lens	9143255	-	-	9143255
Replacement headband	9143011	9143013	-	9143011
Version	uvex supravision excellence	uvex supravision excellence	uvex supravision excellence	uvex supravision excellence
Standard	EN 166, EN 170	EN 166, EN 170	EN 166, EN 172	EN 166, EN 170
Frame	anthracite, blue	anthracite, jade	anthracite, lime	anthracite, blue
	W 166 34 B CE	W 166 34 B CE	W 166 34 B CE	W 166 34 B CE
Lens	PC clear	PC clear	PC grey 23%	PC clear
	UV400	UV400	UV400	UV400
	2C-1.2 W1 BKN CE	2C-1.2 W1 BKN CE	5-2.5 W1 BKN CE	2C-1.2 W1 BKN CE
Weight	50 g	50 g	50 g	56 g
Order quantity multiples	8 PC	8 PC	8 PC	8 PC

MADE IN GERMANY

uvex

stylish. safe. sustainable.

Designed to recycle

Thanks to an innovative new production technology, the uvex pure-fit can be manufactured fully automatically from just one material without the need for additional assembly.

It is made entirely of polycarbonate and is therefore 100% recyclable – just like the product packaging.

This makes the uvex pure-fit an extremely sustainable solution.

Not just innovative but comfortable too:

These safety spectacles are extremely lightweight. The flexible side arms fit perfectly to any head shape and ensure a secure hold.

The uvex pure-fit is available in two different versions: uncoated and, of course, coated with the proven uvex supravision coating technology.



uvex pure-fit



Frameless and innovative lens design for an optimum, unrestricted field of vision



Flexible side arms for a perfect fit and secure hold without creating pressure points

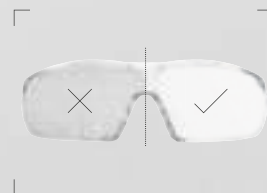

With proven uvex supravision coating technology or uncoated – but always with UV400 protection



Safety Spectacles

uvex pure-fit



scan for QR-Code
for further information.
uvex-safety.com/en/purefit

x-tended sideshield
for additional side protection



reduced to the max – pure, ultra-light-weight safety eyewear made of polycarbonate, weighing only 19 grams



100% recyclable



9145014



9145265

uvex pure-fit



- reduced to the max - pure, ultralight safety spectacle with innovative side arm concept weighing only 19 grams
- frameless lens design for a wide field of vision
- x-tended sideshield offers additional protection from hazards
- flexible side arms deliver the perfect secure, pressure-free fit
- nose bridge designed for all-day comfort
- robust polycarbonate lens with uvex's proven supravision coating technology – permanent anti-fog and scratch-resistant lens
- UV400 – 100% protection against dangerous UV radiation up to 400 nm
- metal-free

uvex pure-fit		
Art. no.	9145014	9145265
Version	uncoated	uvex supravision excellence
Standard	EN 166, EN 170	EN 166, EN 170
Frame	transparent	transparent
	W 166 FT CE	W 166 FT CE
Lens	PC clear	PC clear
	UV400	UV400
	2C-1.2 W1 FT CE	2C-1.2 W1 FTKN CE
Weight	19 g	19 g
Order quantity multiples	75 PC	75 PC



protecting planet

by creating
recyclable products

MADE IN GERMANY

uvex

strong.
sporty.
functional.

eXXtremely cool look
dynamic, attractive
frame design

maXXimum comfort
ergonomically shaped side arms
with soft-grip temple ends for
a comfortable and secure hold

fleXXible nose pad
for a non-slip and
pressure-free fit

eXXcellent vision
with proven uvex supravision
coating technology and UV400
protection



uvex suXXeed

eXXtra protection
against particles, dirt and
dust is provided by the
optional clip-in frame





Safety Spectacles

uvex suXXeed · uvex suXXeed guard

uvex suXXeed protects you all day at work and in almost any situation.

The dynamic look, the perfect-fit frame geometry and the comfortable side arms leave nothing to be desired – wearer acceptance, comfort and protection are guaranteed.

Even during intense physical activity and when performing strenuous work, uvex suXXeed stays where it should be: in front of your eyes, for your protection. The soft, flexible nose pad provides a comfortable, non-slip grip.

If you need even more protection from dust and dirt, you can simply upgrade the uvex suXXeed with an optional clip-in frame.



9181265



9181180



9181281



Accessories: 9181001
Clip-in frame for uvex suXXeed



scan for QR-Code for further information
uvex-safety.com/en/suxxeed-eyewear

uvex suXXeed

- sporty safety spectacle in an appealing, dynamic design
- ergonomically shaped side arms with soft-grip temple ends provide a comfortable, secure fit without pressure
- soft, flexible nose pad adapts to the wearer, delivering a non-slip and pressure-free fit
- UV400 – 100% protection against dangerous UV radiation up to 400 nm

- robust polycarbonate lens with uvex's proven supravision coating technology – permanent anti-fog and scratch-resistant lens
- optional clip-in frame seal provides extra protection against particles, dirt and dust
- a sustainable benefit: lenses can be replaced when required
- metal-free



uvex suXXeed	uvex suXXeed guard	uvex suXXeed guard	clip-in frame
Art. no.	9181265	9181180	9181281
Replacement lens	9181255	9181255	–
Version	uvex supravision excellence	uvex supravision excellence	uvex supravision excellence
Standard Frame	EN 166, EN 170 anthracite, blue W 166 FT CE	incl. clip-in frame EN 166, EN 170 anthracite, blue W 166 FT CE	clip-in frame for uvex suXXeed EN 166, EN 172 anthracite, lime W 166 FT CE
Lens	PC clear UV400 2C-1.2 W1 FTKN CE	PC clear UV400 2C-1.2 W1 FTKN CE	PC grey 23% UV400 5-2.5 W1 FTKN CE
Weight	27 g	32 g	27 g
Order quantity multiples	10 PC	10 PC	10 PC
			5 g 20 PC

MADE IN GERMANY

uvex fitting guide

Useful tips for making sure that your uvex safety eyewear fits perfectly

Wearing just any safety eyewear is not enough to protect your eyes. If your safety eyewear fits poorly or incorrectly, you're putting yourself at a higher risk of injury. Head and face shapes vary considerably, so it's impossible to find one pair that works for everyone. When trying on new safety eyewear, use this guide and review the eyewear description and materials.

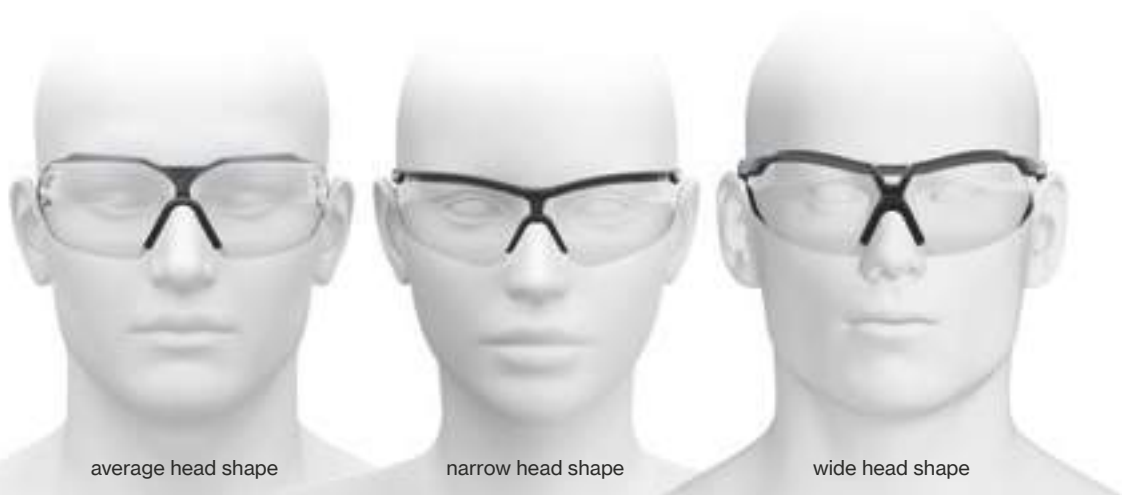

Selecting the right model

Pay attention to:

- excellent fit and eye coverage
- offers a good field of vision
- adjustable to improve fit



Choose the model that best suits you and your work. The shape and fit of the eyewear have an impact on the view, the protection and the wearer comfort.

Checklist

- 1 No uncomfortable pressure points on the side of the head or behind the ears.
- 2 The nose pad is comfortable and lies on your nose without pinching.
- 3 You should be able to see in all directions without your vision being obstructed.



- 4 The overall weight of the safety eyewear is distributed evenly.
- 5 The eyewear fits close to your face without touching your eyelashes. The gap between the eyewear and your face should not exceed 6 to 8 mm.
- 6 The eyewear stays in place when you move your head forwards or backwards and tilt your head side to side.



Safety Spectacles

uvex i-5 · uvex i-5 guard



9183065
9183415
9183265



9183180



9183064



9183223



9183281



Further information can be found at
uvex-safety.com/en/i5
(or scan the QR code).



Accessories: 9183001
Clip-in frame for uvex i-5

uvex i-5

- sporty premium quality safety spectacle with a range of adaptive features
- x-tended eyeshield: soft seal frame technology wraps around the brow providing protection from particle ingress
- x-tended sideshield offers additional protection from hazards
- ergonomically shaped side arms with multi-incline points and length adjustment allow for a high level of individualisation to ensure a good fit for all facial shapes and head widths

- soft-grip temple ends provide a comfortable, secure fit without pressure
- soft, flexible nose pad adapts to the wearer, delivering a non-slip and pressure-free fit
- robust polycarbonate lens with uvex's proven supravision coating technology – permanent anti-fog and scratch-resistant lens
- UV400 – 100% protection against dangerous UV radiation up to 400 nm
- optional clip-in frame seal provides extra protection against particles, dirt and dust
- metal-free



reddot winner 2020



uvex i-5	9183065	9183265	9183415	uvex i-5 guard
Art. no.	9183065	9183265	9183415	9183180
Version	uvex supravision sapphire	uvex supravision excellence	uvex supravision ETC	uvex supravision excellence incl. clip-in frame
Standard Frame	EN 166, EN 170 anthracite, blue W 166 FT CE	EN 166, EN 170 anthracite, blue W 166 FT CE	EN 166, EN 170 anthracite, blue W 166 FT CE	EN 166, EN 170 anthracite, blue W 166 FT CE
Lens	PC clear UV400 2C-1.2 W1 FTK CE	PC clear UV400 2C-1.2 W1 FTKN CE	PC clear UV400 2C-1.2 W1 FTKN CE	PC clear UV400 2C-1.2 W1 FTKN CE
Weight	29 g	29 g	29 g	35 g
Order quantity multiples	10 PC	10 PC	10 PC	10 PC

uvex i-5	9183064	9183223	9183281	clip-in frame
Art. no.	9183064	9183223	9183281	9183001
Version	uvex supravision excellence sunglare filter	uvex supravision excellence sunglare filter	uvex supravision excellence sunglare filter	clip-in frame for uvex i-5
Standard Frame	EN 166, EN 172 white, black W 166 FT CE	EN 166, EN 172 white, black W 166 FT CE	EN 166, EN 172 anthracite, lime W 166 FT CE	anthracite
Lens	PC CBR65 UV400 5-1.4 W1 FTKN CE	PC CBR23 UV400 5-2.5 W1 FTKN CE	PC grey 23% UV400 5-2.5 W1 FTKN CE	
Weight	29 g	29 g	29 g	6 g
Order quantity multiples	10 PC	10 PC	10 PC	20 PC

MADE IN GERMANY

Safety Spectacles

uvex x-fit pro · uvex x-fit pro guard



9199247



9199245



9199680



9199277

uvex x-fit pro

- functional, modular safety spectacle with a wide range of accessories
- ergonomically shaped side arms with soft-grip temple ends provide a comfortable, secure fit without pressure
- adjustment for every head and facial shape with the uvex Comfort Slider – a multi-stage temple inclination that allows wearers to achieve their own comfortable wearing position
- modular system allows functional accessories to be attached enhancing the ability to get on with the job
- soft, flexible nose pad adapts to the wearer, delivering a non-slip and pressure-free fit
- robust polycarbonate lens with uvex's proven supravision coating technology – permanent anti-fog and scratch-resistant lens
- UV400 – 100% protection against dangerous UVA and UVB radiation up to 400 nm
- optional clip-in frame seal provides extra protection against particles, dirt and dust
- metal-free

uvex x-fit pro		uvex x-fit pro guard		
Art. no.	9199247	9199245	9199680	9199277
Version	uvex supravision excellence without sliders	uvex supravision excellence	uvex supravision excellence without sliders, incl. clip-in frame	uvex supravision excellence sunglare filter, without sliders
Standard	EN 166, EN 170	EN 166, EN 170	EN 166, EN 170	EN 166, EN 172
Frame	blue, anthracite W 166 FT CE	blue, anthracite W 166 FT CE	blue, anthracite W 166 FT CE	anthracite, light grey W 166 FT CE
Lens	PC clear UV400 2C-1.2 W1 FTKN CE	PC clear UV400 2C-1.2 W1 FTKN CE	PC clear UV400 2C-1.2 W1 FTKN CE	PC grey 23% UV400 5-2.5 W1 FTKN CE
Weight	24 g	28 g	30 g	24 g
Order quantity multiples	10 PC	10 PC	10 PC	10 PC

MADE IN GERMANY 



Safety Spectacles

uvex x-fit · uvex x-fit guard



9199285
9199085



9199265
9199415



9199180



9199286



9199280



Accessories: 9199001
Clip-in frame for uvex x-fit and uvex x-fit pro



Accessories: 9958023
Headband for uvex x-fit and uvex x-fit pro

uvex x-fit

- classic, close fitting safety spectacle with extension kit options
- frameless lens design for a wide field of vision
- adjustment for every head and facial shape with the optional uvex Comfort Slider - a multi-stage temple inclination that allows wearers to achieve their own comfortable wearing position
- modular system allows functional accessories to be attached enhancing the ability to get on with the job
- nose bridge designed for all-day comfort
- robust polycarbonate lens with uvex's proven supravision coating technology – permanent anti-fog and scratch-resistant lens
- UV400 – 100% protection against dangerous UVA and UVB radiation up to 400 nm
- optional clip-in frame seal provides extra protection against particles, dirt and dust
- metal-free

uvex x-fit				uvex x-fit guard			
Art. no.	9199085	9199285	9199265	9199415	9199180	9199286	9199280
Version	uvex supravision sapphire	uvex supravision excellence	uvex supravision excellence	uvex supravision ETC	uvex supravision excellence incl. clip-in frame	uvex supravision excellence contrast-enhancing	uvex supravision excellence sunglare filter
Standard Frame	EN 166, EN 170 grey translucent W 166 FT CE	EN 166, EN 170 grey translucent W 166 FT CE	EN 166, EN 170 blue translucent W 166 FT CE	EN 166, EN 170 blue translucent W 166 FT CE	EN 166, EN 170 grey translucent W 166 FT CE	EN 166, EN 170 grey translucent W 166 FT CE	EN 166, EN 172 grey translucent W 166 FT CE
Lens	PC clear UV400 2C-1.2 W1 FTK CE	PC clear UV400 2C-1.2 W1 FTKN CE	PC clear UV400 2C-1.2 W1 FTKN CE	PC clear UV400 2C-1.2 W1 FTKN CE	PC clear UV400 2C-1.2 W1 FTKN CE	PC amber UV400 2C-1.2 W1 FTKN CE	PC grey 23% UV400 5-2.5 W1 FTKN CE
Weight	23 g	23 g	23 g	23 g	23 g	23 g	23 g
Order quantity multiples	10 PC	10 PC	10 PC	10 PC	10 PC	10 PC	10 PC

Art. no.	clip-in frame	uvex x-fit pro Headband
Version	9199001	9958023
	clip-in frame for uvex x-fit and uvex x-fit pro	for attaching on uvex x-fit and uvex x-fit pro, metal-free
Colour	black	black
Order unit/		
Order quantity multiples	20 PC	10 PC

Safety Spectacles

uvex sportstyle · uvex sportstyle planet



uvex sportstyle

- sporty, lightweight safety spectacle with a contoured lens that will fit narrow and wider faces equally well
- the combination of soft padding around the brow with ergonomically shaped side arms and soft-grip temple ends provide a comfortable, secure fit without pressure
- soft, adjustable nose pad allows spectacle to be adapted to the wearer to deliver a comfortable, non-slip and pressure-free fit
- robust polycarbonate lens with uvex's proven supravision coating technology – permanent anti-fog and scratch-resistant lens
- UV400 – 100% protection against dangerous UV radiation up to 400 nm
- a sustainable benefit: lenses can be replaced when required

uvex sportstyle	uvex sportstyle planet		uvex sportstyle planet		uvex sportstyle planet	
Art. no.	9193080	9193265	9193295	9193415	9193376	9193395
Replacement lens	-	-	-	-	9193255	-
Version	uvex supravision plus oil & gas	uvex supravision excellence	uvex supravision excellence	uvex supravision ETC	uvex supravision extreme	uvex supravision extreme
Standard	EN 166, EN 170	EN 166, EN 170	EN 166, EN 170	EN 166, EN 170	EN 166, EN 170	EN 166, EN 170
Frame	black, grey W 166 FT CE	black, lime W 166 FT CE	beige, green W 166 FT CE	anthracite, blue W 166 FT CE	black, petrol W 166 FT CE	anthracite, jade W 166 FT CE
Lens	PC clear UV400 2C-1.2 W1 FTKN CE	PC clear UV400 2C-1.2 W1 FTKN CE	PC clear (mass balanced) UV400 2C-1.2 W1 FTKN CE	PC clear UV400 2C-1.2 W1 FTKN CE	PC clear UV400 2C-1.2 W1 FTKN CE	PC clear (mass balanced) UV400 2C-1.2 W1 FTKN CE
Weight	23 g	23 g	23 g	23 g	23 g	23 g
Order quantity multiples	10 PC	10 PC	10 PC	10 PC	10 PC	10 ST

uvex sportstyle	uvex sportstyle planet		uvex sportstyle planet		uvex sportstyle planet	
Art. no.	9193838	9193064	9193223	9193280	9193885	9193880
Version	uvex supravision AR super anti-reflective lenses	uvex supravision extreme sunglare filter	uvex supravision extreme sunglare filter	uvex supravision extreme sunglare filter	anti-fog on the inside sunglare filter, silver mirror	uvex supravision variomatic self-tinting lenses
Standard	EN 166, EN 170	EN 166, EN 172	EN 166, EN 172	EN 166, EN 172	EN 166, EN 172	EN 166, EN 170
Frame	black, blue W 166 FT CE	white, black W 166 FT CE	white, black W 166 FT CE	white, black W 166 FT CE	black, grey W 166 FT CE	black, anthracite W 166 FT CE
Lens	PC clear UV400 2C-1.2 W1 FTN CE	PC CBR65 UV400 5-1.4 W1 FTKN CE	PC CBR23 UV400 5-2.5 W1 FTKN CE	PC grey 23% UV400 5-2.5 W1 FTKN CE	PC silver mirror, grey UV400 5-3.1 W1 FTN CE	PC light green UV400 2-1.2 W1 FTKN CE
Weight	23 g	23 g	23 g	23 g	23 g	23 g
Order quantity multiples	10 PC	10 PC	10 PC	10 PC	10 PC	PC

MADE IN GERMANY



Safety Spectacles

uvex pheos cx2



uvex pheos cx2

- sporty looking safety spectacle with high wearer acceptance
- x-tended eyeshield: soft seal frame technology wraps around the brow providing protection from particle ingress
- ergonomically shaped side arms with soft-grip temple ends provide a comfortable, secure fit without pressure
- soft, flexible nose pad adapts to the wearer, delivering a non-slip and pressure-free fit

- robust polycarbonate lens with uvex's proven supravision coating technology – permanent anti-fog and scratch-resistant lens
- UV400 – 100% protection against dangerous UV radiation up to 400 nm
- metal-free



uvex pheos cx2	9198275	9198257	9198258	9198256	9198415	9198261
Art. no.	9198275	9198257	9198258	9198256	9198415	9198261
Version	uvex supravision sapphire	uvex supravision excellence	uvex supravision excellence	uvex supravision excellence	uvex supravision ETC	uvex supravision extreme
Standard	EN 166, EN 170	EN 166, EN 170	EN 166, EN 170	EN 166, EN 170	EN 166, EN 170	EN 166, EN 170
Frame	blue, grey	blue, grey	red, grey	black, light blue	anthracite, blue	black, light blue
Lens	W 166 FT CE PC clear UV400 2C-1.2 W1 FTKN CE	W 166 FT CE PC clear UV400 2C-1.2 W1 FTKN CE	W 166 FT CE PC clear UV400 2C-1.2 W1 FTKN CE	W 166 FT CE PC clear UV400 2C-1.2 W1 FTKN CE	W 166 FT CE PC clear UV400 2C-1.2 W1 FTKN CE	W 166 FT CE PC clear UV400 2C-1.2 W1 FTKN CE
Weight	28 g	28 g	28 g	28 g	28 g	28 g
Order quantity multiples	10 PC	10 PC	10 PC	10 PC	10 PC	10 PC

uvex pheos cx2	9198285	9198064	9198223	9198237	9198230	9198885
Art. no.	9198285	9198064	9198223	9198237	9198230	9198885
Version	uvex supravision excellence contrast-enhancing	uvex supravision excellence sunglare filter	uvex supravision excellence sunglare filter	uvex supravision excellence sunglare filter	uvex supravision excellence sunglare filter	anti-fog on the inside sunglare filter, silver mirror
Standard	EN 166, EN 170	EN 166, EN 172	EN 166, EN 172	EN 166, EN 172	EN 166, EN 172	EN 166, EN 172
Frame	black, yellow	white, black	white, black	white, black	weiß, schwarz	blue, grey
Lens	W 166 FT CE PC amber UV400 2C-1.2 W 1 FTKN CE	W 166 FT CE PC CBR65 UV400 5-1.4 W 1 FTKN CE	W 166 FT CE PC CBR23 UV400 5-2.5 W1 FTKN CE	W 166 FT CE PC grey 23% UV400 5-2.5 W 1 FTKN CE	W 166 FT CE PC grey 12% UV400 5-3.1 W1 FTKN CE	W 166 FT CE PC silver mirror, grey UV400 5-3.1 W1 FTN CE
Weight	28 g	28 g	28 g	28 g	28 g	28 g
Order quantity multiples	10 PC	10 PC	10 PC	10 PC	10 PC	10 PC

MADE IN GERMANY

Safety Spectacles

uvex pheos · uvex pheos guard



uvex pheos

- sporty, timeless safety spectacle; frameless design allowing for an extra-large field of vision
- ergonomically shaped side arms with soft-grip temple ends provide a comfortable, secure fit without pressure
- nose bridge designed for all-day comfort
- robust polycarbonate lens with uvex's proven supravision coating technology – permanent anti-fog and scratch-resistant lens
- UV400 – 100% protection against dangerous UV radiation up to 400 nm
- optional clip-in frame seal provides extra protection against particles, dirt and dust
- headband option holds eyewear in place during overhead or work in confined spaces
- available as standard size or narrow version
- fits the uvex IES
- metal-free

uvex pheos				uvex pheos CB		
Art. no.	9192080	9192225	9192215	9192485	9192415	9192280
Version	uvex supravision plus standard size, oil & gas	uvex supravision excellence standard size	uvex supravision excellence standard size	uvex supravision excellence standard size	uvex supravision ETC standard size	uvex supravision extreme standard size
Standard	EN 166, EN 170	EN 166, EN 170	EN 166, EN 170	EN 166, EN 170	EN 166, EN 170	EN 166, EN 170
Frame	black, grey	black, green	light grey, grey	black, grey	anthracite, blue	black, grey
Lens	W 166 FT CE PC clear UV400 2C-1.2 W1 FTKN CE	W 166 FT CE PC clear UV400 2C-1.2 W1 FTKN CE	W 166 FT CE PC clear UV400 2C-1.2 W1 FTKN CE	W 166 FT CE PC clear UV400 2C-1.2 W1 FTKN CE	W 166 FT CE PC farblos UV400 2C-1.2 W1 FTKN CE	W 166 FT CE PC clear UV400 2C-1.2 W1 FTKN CE
Weight	29 g	29 g	29 g	30 g	29 g	29 g
Order quantity multiples	10 PC	10 PC	10 PC	10 PC	10 PC	10 PC

uvex pheos					uvex pheos guard
Art. no.	9192385	9192285	9192281	9192881	9192180
Version	uvex supravision excellence standard size, contrast-enhancing	uvex supravision excellence standard size, sunglare filter	uvex supravision extreme standard size, sunglare filter	anti-fog on the inside standard size, sunglare filter, silver mirror	uvex supravision extreme standard size incl. clip-in frame and headband
Standard	EN 166, EN 170	EN 166, EN 172	EN 166, EN 172	EN 166, EN 172	EN 166, EN 170
Frame	black, yellow	black, grey	black, grey	light grey, grey	black, grey
Lens	W 166 FT CE PC amber UV400 2C-1.2 W1 FTKN CE	W 166 FT CE PC grey 23% UV400 5-2.5 W1 FTKN CE	W 166 FT CE PC grey 23% UV400 5-2.5 W1 FTKN CE	W 166 FT CE PC silver mirror grey UV400 5-1.7 W1 FTN CE	W 166 FT CE PC clear UV400 2C-1.2 W1 FTKN CE
Weight	29 g	29 g	29 g	29 g	46 g
Order quantity multiples	10 PC	10 PC	10 PC	10 PC	10 PC

MADE IN GERMANY

Safety Spectacles

uvex pheos s · uvex pheos s guard



9192725



9192785



9192282



9192283



9192680



Accessories: 9192001 / 9192002
Clip-in frame uvex pheos / uvex pheos s



Accessories: 9958020
Headband uvex pheos / uvex pheos s

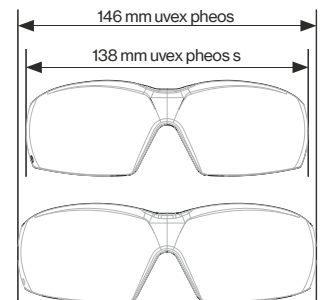

	uvex pheos s				uvex pheos s guard
Art. no.	9192725	9192785	9192282	9192283	9192680
Version	uvex supravision excellence narrow version	uvex supravision excellence narrow version	uvex supravision extreme narrow version	uvex supravision extreme narrow version, sunglare filter	uvex supravision extreme narrow version incl. clip-in frame and headband
Standard Frame	EN 166, EN 170 white, green W 166 FT CE	EN 166, EN 170 anthracite, grey W 166 FT CE	EN 166, EN 170 black, grey W 166 FT CE	EN 166, EN 172 black, grey W 166 FT CE	EN 166, EN 170 black, grey W 166 FT CE
Lens	PC clear UV400 2C-1.2 W1 FTKN CE	PC clear UV400 2C-1.2 W1 FTKN CE	PC clear UV400 2C-1.2 W1 FTKN CE	PC grey 23% UV400 5-2.5 W1 FTKN CE	PC clear UV400 2C-1.2 W1 FTKN CE
Weight	28 g	28 g	28 g	28 g	45 g
Order quantity multiples	10 PC	10 PC	10 PC	10 PC	10 PC

Accessories			
Art. no.	9192001	9192002	9958020
Version	clip-in frame for uvex pheos standard size	clip-in frame for uvex pheos s narrow version	headband for uvex pheos and uvex pheos s
Colour	black	black	grey, black
Order quantity multiples	20 PC	20 PC	10 PC

MADE IN GERMANY 

Safety Spectacles

uvex i-3 · uvex i-3 guard



9190270
9190275



9190280
9190175



9190180



9190839
9190838



9190281
9190181



9190885



9190880

uvex i-3

- adjustable, multi-feature premium quality safety spectacle
- the combination of soft padding around the brow with ergonomically shaped side arms and soft-grip temple ends provide a comfortable, secure fit without pressure
- side arms with multi-incline points allow for a high level of individualisation to ensure a good fit for all facial shapes and head widths
- soft, adjustable nose pad allows spectacle to be adapted to the wearer to deliver a comfortable, non-slip and pressure-free fit

- robust polycarbonate lens with uvex's proven supravision coating technology – permanent anti-fog and scratch-resistant lens
- UV400 – 100% protection against dangerous UV radiation up to 400 nm
- optional clip-in frame seal provides extra protection against particles, dirt and dust
- available as standard size or narrow version
- a sustainable benefit: lenses can be replaced when required
- metal-free

uvex i-3					uvex i-3 guard
Art. no.	9190270	9190175	9190275	9190280	9190180
Replacement lens	–	–	9190258	9190258	9190258
Version	uvex supravision sapphire standard size	uvex supravision plus standard size	uvex supravision excellence standard size	uvex supravision excellence standard size	uvex supravision excellence standard size
		oil & gas			incl. clip-in frame
Standard Frame	EN 166, EN 170 anthracite, blue	EN 166, EN 170 black, light grey	EN 166, EN 170 anthracite, blue	EN 166, EN 170 black, light grey	EN 166, EN 170 anthracite, blue
	W 166 FT CE	W 166 FT CE	W 166 FT CE	W 166 FT CE	W 166 FT CE
Lens	PC clear	PC clear	PC clear	PC clear	PC clear
	UV400	UV400	UV400	UV400	UV400
	2C-1.2 W1 FTK CE	2C-1.2 W1 FTKN CE	2C-1.2 W1 FTKN CE	2C-1.2 W1 FTKN CE	2C-1.2 W1 FTKN CE
Weight	30 g	30 g	30 g	30 g	36 g
Order quantity multiples	10 PC	10 PC	10 PC	10 PC	10 PC

uvex i-3						uvex i-3 guard
Art. no.	9190839	9190838	9190181	9190281	9190885	9190880
Version	uvex supravision AR standard size	uvex supravision AR standard size	uvex supravision plus standard size	uvex supravision excellence standard size	anti-fog on the inside standard size	uvex supravision variomatic standard size
	super anti-reflective lenses	super anti-reflective lenses	sunglare filter, oil & gas	sunglare filter	sunglare filter, silver mirror	self-tinting lenses
Standard Frame	EN 166, EN 170 black, blue	EN 166, EN 170 black, blue	EN 166, EN 172 black, light grey	EN 166, EN 172 black, light grey	EN 166, EN 172 black, light grey	EN 166, EN 170 black, anthracite
	W 166 FT CE	W 166 FT CE	W 166 FT CE	W 166 FT CE	W 166 FT CE	W 166 FT CE
Lens	PC clear	PC clear	PC grey 23%	PC grey 23%	PC silver mirror grey	PC light green
	UV400	UV400	UV400	UV400	UV400	UV400
	2C-1.2 W1 FT CE	2C-1.2 W1 FT CE	5-2.5 W1 FTKN CE	5-2.5 W1 FTKN CE	5-3.1 W1 FTN CE	2-1.2 W1 FTKN CE
Weight	30 g	30 g	30 g	30 g	30 g	30 g
Order quantity multiples/ Order unit	10 PC	PC	10 PC	10 PC	10 PC	PC

MADE IN GERMANY



Safety Spectacles

uvex i-3 s · uvex i-3 s guard



9190075



9190680



9190085



9190086



Accessories: 9190001
Clip-in frame for uvex i-3 and uvex i-3 s

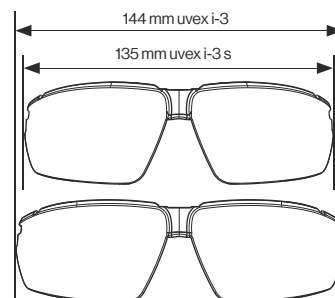

uvex i-3 s	uvex i-3 s guard	uvex i-3 s guard	uvex i-3 s guard	uvex i-3 s guard	Accessories
Art. no.	9190075	9190680	9190085	9190086	9190001
Replacement lens	9190257	9190257	-	-	-
Version	uvex supravision excellence narrow version	uvex supravision excellence narrow version	uvex supravision excellence narrow version	uvex supravision excellence narrow version	clip-in frame for uvex i-3 and uvex i-3 s
Standard Frame	EN 166, EN 170 anthracite, lime	incl. clip-in frame EN 166, EN 170 anthracite, lime	contrast-enhancing EN 166, EN 170 anthracite, yellow	sunglare filter EN 166, EN 172 anthracite, grey	black
Lens	W 166 FT CE PC clear UV400 2C-1.2 W1 FTKN CE	W 166 FT CE PC clear UV400 2C-1.2 W1 FTKN CE	W 166 FT CE PC amber UV400 2C-1.2 W1 FTKN CE	W 166 FT CE PC grey 23 % UV400 5-2.5 W1 FTKN CE	
Weight	29 g	35 g	29 g	29 g	6 g
Order quantity multiples	10 PC	10 PC	10 PC	10 PC	20 PC

uvex safety eyewear

Also ideal for narrow faces

The geometries of our spectacles are as different as the faces of the people who wear them. The products in this range can be worn by anyone, but are particularly suitable for people with narrow faces.

Their optimal fit and the fact that they can be adjusted mean that these safety spectacles fit different head shapes perfectly, providing the wearer with the best possible protection from particles, sparks or dust.

uvex has a range of safety eyewear
to meet every need —
including those
with narrower faces.

uvex spectacles:



uvex pheos nxt 9128



uvex x-fit 9199



uvex sportstyle 9193



uvex pheos cx2 9198



uvex pheos s 9192



uvex i-3 s 9190



uvex i-works 9194

uvex goggles:



uvex i-guard+ 9143



uvex pheos s guard 9192



uvex pheos cx2 sonic 9309





Safety Spectacles

uvex i-works



9194171



9194175



9194365



9194270



9194885

uvex i-works

- sporty, robust safety spectacle, available in a range of lens shades
- ergonomically shaped side arms with soft-grip temple ends provide a comfortable, secure fit without pressure
- nose bridge designed for all-day comfort
- robust polycarbonate lens with uvex's proven supravision coating technology – permanent anti-fog and scratch-resistant lens

- UV400 – 100% protection against dangerous UV radiation up to 400 nm
- fits the uvex IES
- a sustainable benefit: lenses can be replaced when required
- metal-free

uvex i-works					
Art. no.	9194171	9194175	9194365	9194270	9194885
Replacement lens	9194255	9194255	-	-	-
Version	uvex supravision excellence	uvex supravision excellence	uvex supravision excellence contrast-enhancing	uvex supravision excellence sunglare filter	anti-fog on the inside silver mirror
Standard	EN 166, EN 170	EN 166, EN 170	EN 166, EN 170	EN 166, EN 172	EN 166, EN 172
Frame	anthracite, blue W 166 FT CE	anthracite, green W 166 FT CE	black, yellow W 166 FT CE	anthracite, grey W 166 FT CE	black, grey W 166 FT CE
Lens	PC clear UV400 2C-1.2 W1 FTKN CE	PC clear UV400 2C-1.2 W1 FTKN CE	PC amber UV400 2C-1.2 W1 FTKN CE	PC grey 23% UV400 5-2.5 W1 FTKN CE	PC silver mirror grey UV400 5-1.7 W1 FTN CE
Weight	26 g	26 g	26 g	26 g	26 g
Order quantity multiples	10 PC	10 PC	10 PC	10 PC	10 PC

MADE IN GERMANY

Safety eyewear – matching your corporate identity

Eye protection with “personality”

Give your team an unmistakable image: uvex safety eyewear offer various options for individual design – from printing your company’s logo on the side arms to frames in your company’s colours. You can coordinate your protective equipment perfectly with your corporate identity.

Frames in the company colours

“Your” safety spectacles are recognisable at first glance: the frames are designed in your company colours.



Insert in the side arms

Adding your company name to the soft components of the side arms is both bespoke and subtle.

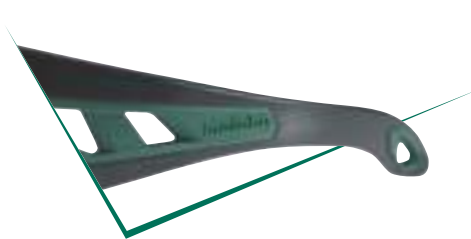

Pad printing on the side arms (1 to 4 colours)

The direct pad printing process is recommended for printing your logo in colour on the side arms.

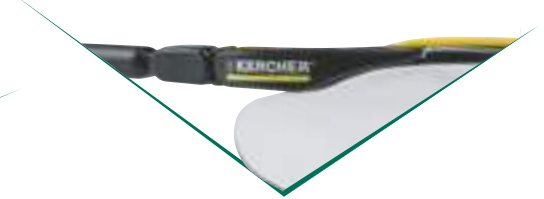

How individual can you be?

We are happy to advise you personally on the technical options for customising our safety eyewear.

Please note that the following minimum quantities must be ordered:

Pad printing – minimum of 500 pairs

A combination of either lens and/or frame, with and without pad printing - minimum of 2,500 pairs.

Insert/customised corporate colouring/individual headband/

laser engraving – minimum of 5,000 pairs

Customised accessories available on request

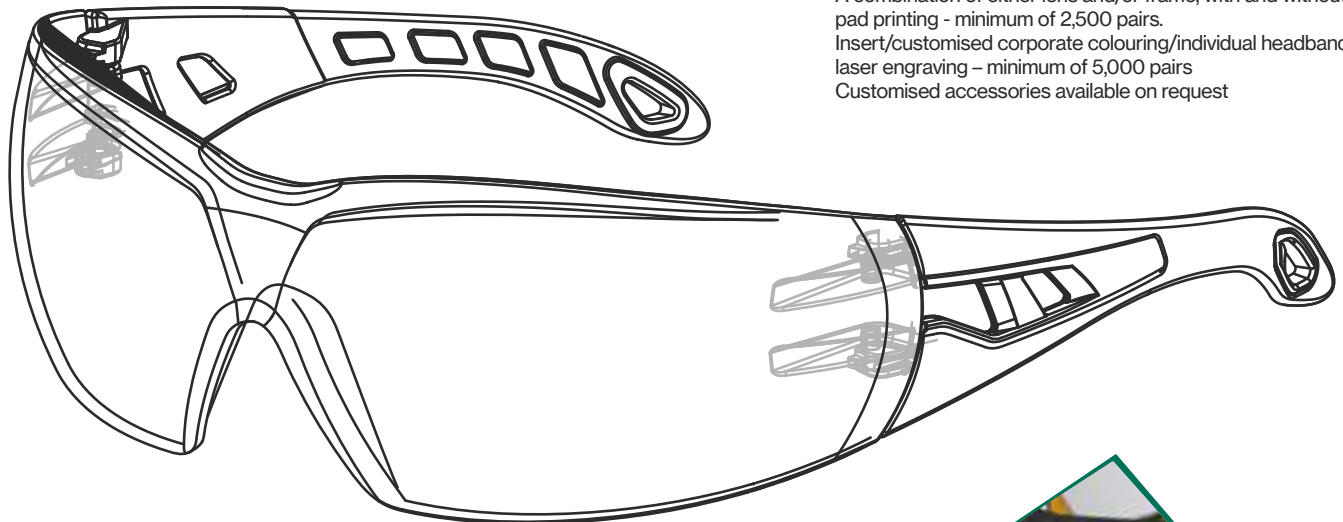

Customised accessories

Have your logo printed on your spectacle case.



Laser engraving on the lens

Safety spectacles will retain 100% of their functionality even with customised laser engraving.



Headband embroidery

Customise your goggles by having your corporate logo embroidered on the headband.



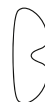

Safety Spectacles

uvex astrospec 2.0



9164065



9164187



9164285



9164275



9164276



9164246



Accessories: 6109200
RX insert for uvex astrospec 2.0

uvex astrospec 2.0

- classic safety spectacle with flat lens for a wide field of vision
- ergonomically shaped side arms with multi-incline points allow for a high level of individualisation to ensure a good fit for all facial shapes and head widths
- side arms with soft-grip temple ends provide a comfortable, secure fit without pressure
- nose bridge designed for all-day comfort
- robust polycarbonate lens with uvex's proven supravision coating technology – permanent anti-fog and scratch-resistant lens
- UV400 – 100% protection against dangerous UV radiation up to 400 nm

uvex astrospec 2.0					uvex astrospec 2.0 CB		Accessories
Art. no.	9164065	9164187	9164285	9164275	9164276	9164246	6109200
Version	uvex supravision sapphire	uvex supravision plus oil & gas	uvex supravision excellence	uvex supravision extreme	uvex supravision extreme lower nose bridge, high cheekbone design, ISO 18526-4:2020	uvex supravision excellence sunglare filter	RX insert for uvex astrospec 2.0
Standard	EN 166, EN 170	EN 166, EN 170	EN 166, EN 170	EN 166, EN 170	EN 166, EN 170	EN 166, EN 172	
Frame	blue, light blue	black, grey	black, lime	anthracite, petrol	blue, light blue	neon orange, black	clear
	W 166 FT CE	W 166 FT CE	W 166 FT CE	W 166 FT CE	W 166 FT CE	W 166 FT CE	
Lens	PC clear	PC clear	PC clear	PC clear	PC clear	PC grey 23%	
	UV400	UV400	UV400	UV400	UV400	UV400	
	2C-1.2 W1 FTK CE	2C-1.2 W1 FTKN CE	2C-1.2 W1 FTKN CE	2C-1.2 W1 FTKN CE	2C-1.2 W1 FTKN CE	5-2.5 W1 FTKN CE	
Weight	42 g	42 g	42 g	42 g	43 g	42 g	6g
Order quantity multiples/	10 PC	10 PC	10 PC	10 PC	10 PC	10 PC	PC
Order unit							

MADE IN GERMANY

Safety Spectacles

uvex super g



9172085



9172110
9172210



9172265



9172281

uvex super g

- sporty, extremely lightweight safety spectacle with innovative temple concept for high levels of comfort
- flexible side arms with soft-grip temple ends provide a comfortable, secure fit without pressure
- soft, flexible nose pad for a non-slip and pressure-free fit

- robust polycarbonate lens with uvex's proven supravision coating technology – permanent anti-fog and scratch-resistant lens
- UV400 – 100% protection against dangerous UV radiation up to 400 nm
- a sustainable benefit: lenses can be replaced when required
- metal-free

uvex super g					
Art. no.	9172085	9172110	9172210	9172265	9172281
Replacement lens	–	–	9172255	9172255	–
Version	uvex supravision sapphire	uvex supravision plus	uvex supravision excellence	uvex supravision excellence	uvex supravision excellence sunglare filter
Standard	EN 166, EN 170	EN 166, EN 170	EN 166, EN 170	EN 166, EN 170	EN 166, EN 172
Frame	grey metallic, black W 166 FT CE	clear, grey W 166 FT CE	clear, grey W 166 FT CE	navy blue, white W 166 FT CE	anthracite, lime W 166 FT CE
Lens	PC clear UV400 2C-1.2 W1 FTK CE	PC clear UV400 2C-1.2 W1 FTKN CE	PC clear UV400 2C-1.2 W1 FTKN CE	PC clear UV400 2C-1.2 W1 FTKN CE	PC grey 23% UV400 5-2.5 W1 FTKN CE
Weight	18 g	18 g	18 g	18 g	18 g
Order quantity multiples	10 PC	10 PC	10 PC	10 PC	10 PC

MADE IN GERMANY 



Safety Spectacles

uvex super fit



9178065
9178265



9178185



9178315



9178415



9178286

uvex super fit

- sporty safety spectacle with slim, flat side arms, making it highly compatible with other PPE
- the combination of soft padding around the brow with ergonomically shaped side arms and soft-grip temple ends provide a comfortable, secure fit without pressure
- soft, adjustable nose pad allows spectacle to be adapted to the wearer to deliver a comfortable, non-slip and pressure-free fit
- robust polycarbonate lens with uvex's proven supravision coating technology – permanent anti-fog and scratch-resistant lens
- UV400 – 100% protection against dangerous UV radiation up to 400 nm
- a sustainable benefit: lenses can be replaced when required

uvex super fit						
Art. no.	9178065	9178185	9178265	9178315	9178415	9178286
Replacement lens	-	-	9172255	9172255	-	-
Version	uvex supravision sapphire	uvex supravision plus	uvex supravision excellence	uvex supravision excellence	uvex supravision ETC	uvex supravision excellence
						sunglare filter
Standard	EN 166, EN 170	EN 166, EN 170	EN 166, EN 170	EN 166, EN 170	EN 166, EN 170	EN 166, EN 172
Frame	navy blue, white	black, white	navy blue, white	white, lime	white, grey	black, white
	W 166 FT CE	W 166 FT CE	W 166 FT CE	W 166 FT CE	W 166 FT CE	W 166 FT CE
Lens	PC clear	PC clear	PC clear	PC clear	PC clear	PC grey 23%
	UV400	UV400	UV400	UV400	UV400	UV400
	2C-1.2 W1 FTK CE	2C-1.2 W1 FTKN CE	2C-1.2 W1 FTKN CE	2C-1.2 W1 FTKN CE	2C-1.2 W1 FTN CE	5-2.5 W1 FTKN CE
Weight	21 g	21 g	21 g	21 g	21 g	21 g
Order quantity multiples	10 PC	10 PC	10 PC	10 PC	10 PC	10 PC

MADE IN GERMANY

Safety Spectacles

uvex i-vo



9160065
9160265



9160275



9160520



9160076

uvex i-vo

- functional safety spectacle with a wide range of features and adjustment options
- side arms with multi-incline points and length adjustment allow spectacle to be adapted to ensure a good fit for all facial shapes and head widths
- soft-grip temple ends provide a comfortable, secure fit without pressure
- soft, flexible nose pad for a non-slip and pressure-free fit
- robust polycarbonate lens with uvex's proven supravision coating technology – permanent anti-fog and scratch-resistant lens
- UV400 – 100% protection against dangerous UV radiation up to 400 nm

uvex i-vo	9160065	9160265	9160275	9160520	9160076
Art. no.	9160065	9160265	9160275	9160520	9160076
Version	uvex supravision sapphire	uvex supravision excellence	uvex supravision excellence	uvex supravision sapphire contrast-enhancing	uvex supravision sapphire sunglare filter
Standard	EN 166, EN 170	EN 166, EN 170	EN 166, EN 170	EN 166, EN 170	EN 166, EN 172
Frame	blue, orange W 166 FT CE	blue, orange W 166 FT CE	black, grey W 166 FT CE	blue, orange W 166 FT CE	black, grey W 166 FT CE
Lens	PC clear UV400 2C-1.2 W1 FTK CE	PC clear UV400 2C-1.2 W1 FTKN CE	PC clear UV400 2C-1.2 W1 FTKN CE	PC amber UV400 2C-1.2 W1 FTK CE	PC grey 23% UV400 5-2.5 W1 FTK CE
Weight	33 g	33 g	33 g	33 g	33 g
Order quantity multiples	10 PC	10 PC	10 PC	10 PC	10 PC

MADE IN GERMANY 



You can find more information at uvex-academy.com

Industrial protective eyewear

A practical introductory seminar on the selection, use and benefits of protective eyewear



- The basic applications of safety eyewear, including which products protect against mechanical dangers, chemical and radiation risks (e.g. welding protection), and products designed for specialised applications
- Demonstration and assessment of the dangers posed by mechanical risks, infrared and ultraviolet radiation (e.g. encountered during welding applications or during the use of chemicals), illustrated by case studies
- Assessment of the risk of eye injury in the workplace
- Explanation of how these risks can be dealt with efficiently in each workplace
- Comprehensive overview of the requirements of industrial safety eyewear, standards, applications, risk assessment and how to care for protective eyewear
- Information on the classification of protection products based on their labelling and the areas of application of the various types of equipment

Target group

Those responsible for the work-related health and safety of employees within a company, e.g. health and safety officers, occupational nurses and specialist purchasers

For more information or to book a place, please visit uvex-academy.de, call +49 (0)911 9736 1710 or email academy@uvex.de



Safety Spectacles

uvex meteor · uvex polavision · uvex mercury · uvex ceramic



9134005
9134002

MADE IN GERMANY

uvex meteor

- classic flat, dual lens safety spectacle with good coverage
- extendable soft-grip side arms offer adaptable, pressure-free comfort and a stable, non-slip fit
- nose bridge designed for all-day comfort
- robust polycarbonate lens with uvex's proven supravision coating technology – both sides scratch-resistant lens
- UV400 – 100% protection against dangerous UV radiation up to 400 nm
- metal-free

uvex meteor		
Art. no.	9134005	9134002
Version	uvex supravision sapphire	uncoated
	lens 56 mm	lens 56 mm
	bridge width 15 mm	bridge width 15 mm
Standard Frame	EN 166, EN 170	EN 166
	grey, transparent	grey transparent
Lens	W 166 F CE	W 166 F CE
	PC clear	HG clear
	UV400	UV330
	2-1.2 W1 FK	W1 S
Weight	28 g	44 g
Order quantity multiples	5 PC	5 PC



9155005

MADE IN GERMANY

uvex mercury

- classic metal safety spectacle with flat design for easy stowage
- side arms with soft-grip temple ends provide a secure fit without pressure
- soft, adjustable loop style nose bridge delivers a comfortable, non-slip and pressure-free fit
- robust polycarbonate lens with uvex's proven supravision coating technology – both sides scratch-resistant lens
- UV400 – 100% protection against dangerous UV radiation up to 400 nm

uvex mercury	
Art. no.	9155005
Version	uvex supravision sapphire
	lens 54 mm
	bridge width 19 mm
Standard Frame	EN 166, EN 170
	steel blue
	W 166 F CE
Lens	PC clear
	UV400
	2C-1.2 W1 FK CE
Weight	30 g
Order quantity multiples	5 PC



9231960

uvex polavision

- sporty dual lens safety spectacle with polarised filter
- uvex polavision technology protects against reflections and optical irritations outdoors helping to ease eye strain e.g. highly reflective surfaces such as water or glass
- side arms with soft-grip temple ends provide a comfortable, secure fit without pressure
- soft, flexible nose pad for a non-slip and pressure-free fit
- robust polycarbonate lens with UV400 – 100% protection against dangerous UV radiation up to 400 nm

uvex polavision	
Art. no.	9231960
Version	scratch-resistant on both sides
	sunglare filter
Standard Frame	EN 166, EN 172
	black, white
	W 166 F CE
Lens	PC grey 14%
	UV400
	5-3.1 W 1 F CE
Weight	25 g
Order unit	PC



9137100

uvex ceramic

- classic dual lens safety spectacle especially suitable for narrow facial shapes
- side arms with soft-grip temple ends provide a secure fit without pressure
- nose bridge designed for all-day comfort
- robust polycarbonate lens with UV400 – 100% protection against dangerous UV radiation up to 400 nm

uvex ceramic	
Art. no.	9137005
Version	scratch-resistant on both sides
	lens 49 mm
	bridge width 20 mm
Standard Frame	EN 166, EN 170
	dark grey translucent
	W 166 FT CE
Lens	PC clear
	UV400
	2C-1.2 W1 FTK CE
Weight	28 g
Order quantity multiples	5 PC



Safety Spectacles & Overspecs

uvex winner · uvex 9161



9159005
9159105



9159118

uvex winner

- classic, rimless metal safety spectacle
- side arms with soft-grip temple ends provide a secure fit without pressure
- soft, adjustable nose pad for a comfortable, non-slip and pressure-free fit

- robust polycarbonate lens with UV400 – 100% protection against dangerous UV radiation up to 400 nm

uvex winner			
Art. no.	9159005	9159105	9159118
Version	scratch-resistant on both sides	scratch-resistant, anti-fog	scratch-resistant, anti-fog sunglare filter
Standard	EN 166, EN 170	EN 166, EN 170	EN 166, EN 172
Frame	gun W 166 F CE	gun W 166 F CE	gun W 166 F CE
Lens	PC clear UV400 2-1.2 W1 F CE	PC clear UV400 2-1.2 W1 FKN CE	PC grey 23% UV400 5-2.5 W1 FKN CE
Weight	29 g	29 g	29 g
Order quantity multiples	5 PC	5 PC	5 PC



9161014



9161005
9161305

MADE IN GERMANY

uvex 9161

- robust overspecs for prescription spectacle wearers with flat lens for a wide field of vision
- side arms with multi-incline points and length adjustment allow overspecs to be adapted to ensure a good fit for all facial shapes and head widths (except 9161014)
- soft-grip temple ends provide pressure-free comfort and a stable, non-slip fit (except 9161014)

- nose bridge designed for all-day comfort
- robust polycarbonate lens with uvex's proven supravision coating technology – permanent anti-fog and scratch-resistant lens
- UV400 – 100% protection against dangerous UV radiation up to 400 nm
- metal-free

uvex 9161			
Art. no.	9161014	9161005	9161305
Version	uncoated	uvex supravision sapphire	uvex supravision plus
Standard	EN 166, EN 170	EN 166, EN 170	EN 166, EN 170
Frame	clear W 166 F CE	blue, black W 166 F CE	blue, black W 166 F CE
Lens	PC clear UV400 2C-1.2 W1 F CE	PC clear UV400 2C-1.2 W1 FK CE	PC clear UV400 2C-1.2 W1 FKN CE
Weight	51 g	46 g	46 g
Order quantity multiples	5 PC	5 PC	5 PC

Overspecs

uvex super OTG · uvex super OTG planet



9169065
9169260



9169080



9169295



9169081

uvex super OTG

- classic overspecs for prescription spectacle wearers with an innovative temple concept and a flat lens that offers a wide field of vision
- flexible side arms with soft-grip temple ends provide a comfortable, secure fit without pressure
- nose bridge designed for all-day comfort
- robust polycarbonate lens with uvex's proven supravision coating technology – permanent anti-fog and scratch-resistant lens
- UV400 – 100% protection against dangerous UV radiation up to 400 nm
- a sustainable benefit: lenses can be replaced when required
- metal-free

uvex super OTG			uvex super OTG planet		
Art. no.	9169065	9169080	9169260	9169295	9169081
Replacement lens	–	–	9169255	–	–
Version	uvex supravision sapphire	uvex supravision sapphire	uvex supravision excellence	uvex supravision excellence	uvex supravision sapphire sunglare filter
Standard	EN 166, EN 170	EN 166, EN 170	EN 166, EN 170	EN 166, EN 170	EN 166, EN 172
Frame	blue, light grey W 166 FT CE	black, light grey W 166 FT CE	blue, light grey W 166 FT CE	anthracite, jade W 166 FT CE	black, light grey W 166 FT CE
Lens	PC clear UV400 2C-1.2 W1 FTK CE	PC clear UV400 2C-1.2 W1 FTK CE	PC clear UV400 2C-1.2 W1 FTKN CE	PC clear (mass balanced) UV400 2C-1.2 W1 FTKN CE	PC grey 23% UV400 5-2.5 W1 FTK CE
Weight	37 g	37 g	37 g	37 g	37 g
Order quantity multiples	8 PC	8 PC	8 PC	8 PC	8 PC



Overspecs

uvex super f OTG



9169261
9169585



9169415
9169500



9169164



9169586



9169850



9169615

uvex super f OTG

- classic overspecs for prescription spectacle wearers with a flat lens for a wide field of vision, designed for maximum wearer acceptance
- side arms with soft-grip temple ends provide a comfortable, secure fit without pressure
- nose bridge designed for all-day comfort
- robust polycarbonate lens with uvex's proven supravision coating technology – permanent anti-fog and scratch-resistant lens
- UV400 – 100 % protection against dangerous UV radiation up to 400 nm
- a sustainable benefit: lenses can be replaced when required

uvex super f OTG								
Art. no.	9169585	9169261	9169415	9169500	9169164	9169586	9169850	9169615
Replacement lens	-	9169255	-	-	-	-	-	-
Version	uvex supravision sapphire	uvex supravision excellence	uvex supravision ETC	uvex supravision clean autoclavable (20 cycles)	uvex supravision excellence sunglare filter	uvex supravision sapphire sunglare filter	uvex supravision variomatic	uvex supravision sapphire blocks blue light to 525 nm
Standard Frame	EN 166, EN 170 black, clear W 166 FT CE	EN 166, EN 170 black, clear W 166 FT CE	EN 166, EN 170 white, light blue W 166 FT CE	EN 166, EN 170 white, light blue W 166 FT CE	EN 166, EN 172 black, clear W 166 FT CE	EN 166, EN 172 black, clear W 166 FT CE	EN 166, EN 170 black, clear W 166 FT CE	EN 166, EN 170 black, clear W 166 FT CE
Lens	PC clear UV400 2C-1.2 W1 FTK CE	PC clear UV400 2C-1.2 W1 FTKN CE	PC clear UV400 2C-1.2 W1 FTKN CE	PC clear UV400 2C-1.2 1 FTKN CE	PC CBR65 UV400 5-1.4 W1 FTKN CE	PC grey 23% UV400 5-2.5 W1 FTK CE	PC light green UV400 2-1.2 W1 FTKN CE	PC orange UV525 2-1.4 W1 FTK CE
Weight	39 g	39 g	39 g	39 g	39 g	39 g	39 g	39 g
Order quantity multiples/	8 PC	8 PC	8 PC	8 PC	8 PC	8 PC	PC	8 PC

Safety Goggles

uvex megasonic · uvex megasonic planet



9320415
9320265



9320295



9320475



9320500



9320223



9320281

uvex megasonic

- functional safety goggle in ski goggle design with a truly panoramic field of vision
- unique frameless lens design for edge-to-edge optical clarity and increased safety
- soft, adaptive face seal providing a universal fit for different head and facial shapes as well as a tight fit without pressure points
- generous internal volume to accommodate prescription spectacles and frame recesses to locate the side arms ensuring a comfortable fit
- indirect ventilation system increases air circulation

- length-adjustable 30 mm wide textile headband for optimal low pressure hold and individual adaptability
- robust polycarbonate lens with uvex's proven supravision coating technology – permanent anti-fog and scratch-resistant lens
- UV400 – 100% protection against dangerous UV radiation up to 400 nm
- a sustainable benefit: lenses and headbands can be replaced when required
- metal-free



reddot winner 2020

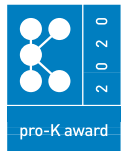

Further information can be found at uvex-safety.com/en/megasonic (or scan the QR code).

uvex megasonic	uvex megasonic planet						
Art. no.	9320265	9320295	9320415	9320475	9320500	9320223	9320281
Replacement lens	9320255	-	9320455	-	9320259	-	9320257
Replacement headband	9320011	-	9320011	9320012	-	-	9320012
Version	uvex supravision excellence	uvex supravision excellence	uvex supravision ETC	uvex supravision extreme closed ventilation (gas-proof)	uvex supravision clean autoclavable (20 cycles)	uvex supravision excellence sunglare filter	uvex supravision excellence sunglare filter
Standard	EN 166, EN 170	EN 166, EN 170	EN 166, EN 170	EN 166, EN 170	EN 166, EN 170	EN 166, EN 172	EN 166, EN 172
Frame	anthracite, blue W 166 34 BT CE	anthracite, jade W 166 34 BT CE	anthracite, blue W 166 34 BT CE	anthracite, lime W 166 345 BT CE	transparent, white W 166 34 F CE	black, grey W 166 34 BT CE	anthracite, lime W 166 34 BT CE
Lens	PC clear UV400 2C-1.2 W1 BTKN CE	PC clear (mass balanced) UV400 2C-1.2 W1 BTKN CE	PC clear UV400 2C-1.2 W1 BTKN CE	PC clear UV400 2C-1.2 W1 BTKN CE	PC clear UV400 2C-1.2 W1 FKN CE	PC CBR23 UV400 5-2.5 W1 BTKN CE	PC grey 23% UV400 5-2.5 W1 BTKN CE
Weight	96 g	96 g	96 g	98 g	107 g	96 g	96 g
Order quantity multiples	4 PC	4 PC	4 PC	4 PC	4 PC	4 PC	4 PC

MADE IN GERMANY

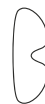

Safety Goggles

uvex pheos cx2 sonic



9309275



9309064



9309286

uvex pheos cx2 sonic

- sporty, compact and extremely lightweight safety goggle
- very soft and flexible, ergonomic face seal for a custom fit and ultimate comfort
- indirect ventilation system increases air circulation
- very light, length-adjustable textile headband for a secure fit and individual adaptability

- robust polycarbonate lens with uvex's proven supravision coating technology – permanent anti-fog and scratch-resistant lens
- UV400 – 100% protection against dangerous UV radiation up to 400 nm
- metal-free

uvex pheos cx2 sonic			
Art. no.	9309275	9309064	9309286
Version	uvex supravision extreme	uvex supravision extreme	uvex supravision extreme
Standard	EN 166, EN 170	EN 166, EN 172	EN 166, EN 172
Frame	white, black W 166 34 BT CE	white, black W 166 34 BT CE	white, black W 166 34 BT CE
Lens	PC clear UV400 2C-1.2 W1 BTKN CE	PC CBR65 UV400 5-1.4 W1 BTKN CE	PC grey 23% UV400 5-2.5 W1 BTKN CE
Weight	34 g	34 g	34 g
Order quantity multiples	10 PC	10 PC	10 PC

uvex

uvex CR

Autoclave safety eyewear that goes further

Innovative coating technology –
the first autoclavable safety eyewear
with anti-fog performance

uvex has developed the first autoclavable safety eyewear with anti-fog coating for specialist requirements in laboratories, clinics, cleanrooms and food manufacturing. From ultra-light safety spectacles and goggles with a panoramic lens, the uvex CR is the ideal safety eyewear for all areas of application and specifically have been designed for repeated autoclave sterilisation (20 times for 20 minutes each at a max. of 121°C).

uvex CR – professional safety eyewear that compliments hygiene standards.



9169500

uvex super f OTG CR

- classic overspecs for prescription spectacle wearers with a flat lens for wide field of vision, designed for maximum wearer acceptance
- side arms with soft-grip temple ends provide a comfortable, secure fit without pressure
- nose bridge designed for all-day comfort

- robust polycarbonate lens with uvex's proven infraradur coating technology – permanent anti-fog and scratch-resistant lens
- UV400 – 100% protection against dangerous UV radiation up to 400 nm



9320500



9302500

uvex megasonic CR

- functional safety goggles in ski goggle design with a truly panoramic field of vision
- unique frameless lens design for edge-to-edge optical clarity and increased safety
- soft, adaptive face seal providing a universal fit for different head and facial shapes as well as a tight fit without pressure points
- generous internal volume to accommodate prescription spectacles and frame recesses to locate the side arms ensuring a comfortable fit
- indirect ventilation system increases air circulation
- length-adjustable 30 mm wide silicone headband for optimal low pressure hold and individual adaptability
- robust polycarbonate lens with uvex's proven supravision coating technology – permanent anti-fog and scratch-resistant lens
- UV400 – 100% protection against dangerous UV radiation up to 400 nm
- a sustainable benefit: lenses can be replaced when required
- metal-free

uvex ultrasonic CR

- functional safety goggle with panoramic lens suitable for a wide range of applications
- soft, flexible face seal naturally moulds to any facial shape
- generous internal volume to accommodate prescription spectacles and ensure a comfortable fit
- indirect ventilation system increases air circulation
- length-adjustable silicone headband for a secure fit and individual adaptability
- robust polycarbonate lens with uvex's proven supravision coating technology – permanent anti-fog and scratch-resistant lens
- UV400 – 100% protection against dangerous UV radiation up to 400 nm
- a sustainable benefit: lenses can be replaced when required
- metal-free

MADE IN GERMANY 



Safety Goggles

uvex ultrasonic · uvex ultrasonic planet



9302245



9302285



9302290



9302275



9302601



9302600



9302500



9302286

uvex ultrasonic

- functional safety goggle with panoramic lens suitable for a wide range of applications
- soft, flexible face seal naturally moulds to any facial shape
- generous internal volume to accommodate prescription spectacles and ensure a comfortable fit
- indirect ventilation system increases air circulation
- length-adjustable textile or silicone headband for a secure fit and individual adaptability

- robust polycarbonate lens with uvex's proven supravision coating technology – permanent anti-fog and scratch-resistant lens
- UV400 – 100% protection against dangerous UV radiation up to 400 nm
- a sustainable benefit: lenses can be replaced when required
- metal-free

uvex ultrasonic		uvex ultrasonic planet	
Art. no.	9302245	9302285	9302290
Replacement lens	9302255	9302255	–
Version	uvex supravision excellence	uvex supravision excellence	uvex supravision excellence
Standard	EN 166, EN 170	EN 166, EN 170	EN 166, EN 170
Frame	grey, orange	black, grey	anthracite, jade
	W 166 34 B CE	W 166 34 B CE	W 166 34 B CE
Lens	PC clear	PC clear	PC clear (mass balanced)
	UV400	UV400	UV400
	2C-1.2 W1 BKN CE	2C-1.2 W1 BKN CE	2C-1.2 W1 BKN CE
Weight	83 g	83 g	83 g
Order quantity multiples	4 PC	4 PC	4 PC

Art. no.	9302601	9302600	9302500	9302286
Replacement lens	9302155	9302155	9302259	9302256
Version	uvex supravision extreme reduced ventilation	uvex supravision extreme reduced ventilation	uvex supravision clean autoclavable (20 cycles)	uvex supravision excellence sunglare filter
Standard	EN 166, EN 170	EN 166, EN 170	EN 166, EN 170	EN 166, EN 172
Frame	black, red	blue, grey	transparent, white	black, grey
	W 166 34 B CE	W 166 34 B CE	W 166 34 B CE	W 166 34 B CE
Lens	PC clear	PC clear	PC clear	PC grey 23%
	UV400	UV400	UV400	UV400
	2C-1.2 W1 BKN CE	2C-1.2 W1 BKN CE	2C-1.2 W1 BKN CE	5-2.5 W1 BKN CE
Weight	95 g	95 g	95 g	83 g
Order quantity multiples	4 PC	4 PC	4 PC	4 PC

MADE IN GERMANY

Safety Goggles

uvex ultravision



9301714



9301906



9301716



9301424

Please note:
CA lenses do not fit the PC models
and vice-versa.

uvex ultravision

- classic safety goggle suitable for a wide range of applications
- flexible face seal naturally moulds to any facial shape
- generous internal volume accommodating prescription spectacles and frame recesses to locate the side arms ensuring a comfortable fit
- indirect ventilation system increases air circulation
- length-adjustable textile or neoprene headband for a secure fit and individual adaptability
- robust polycarbonate lens with uvex's proven supravision coating technology – permanent anti-fog and scratch-resistant lens
- UV400 – 100% protection against dangerous UV radiation up to 400 nm
- also available with a cellulose acetate lens featuring anti-fog performance on the inside and UV380 protection
- a sustainable benefit: lenses can be replaced when required
- metal-free

uvex ultravision				
Art. no.	9301714	9301906	9301716	9301424
Replacement lens	9300517	9300956	9300517	9300517
Version	anti-fog on the inside	anti-fog on the inside wide nose piece, particularly well suited in combination with dust masks	anti-fog on the inside with foam layer	anti-fog on the inside with neoprene headband
Standard	EN 166, EN 170	EN 166, EN 170	EN 166, EN 170	EN 166, EN 170
Frame	transparent grey W 166 34 F CE	transparent grey W 166 3 F CE	transparent grey W 166 34 F CE	transparent grey W 166 34 F CE
Lens	CA clear UV380 2C-1.2 W1 FN CE	CA clear UV380 2C-1.2 W1 FN CE	CA clear UV380 2C-1.2 W1 FN CE	CA clear UV380 2C-1.2 W1 FN CE
Weight	116 g	130 g	118 g	108 g
Order quantity multiples	4 PC	4 PC	4 PC	4 PC



Safety Goggles

uvex ultravision



9301605



9301116



9301105



9301626



9301813



9301815



9301613



9301633

uvex ultravision				
Art. no.	9301605	9301116	9301105	9301626
Replacement lens	-	-	9301255	9301255
Tear-off films	-	-	-	-
Version	uvex supravision plus	uvex supravision plus with foam layer	uvex supravision excellence	uvex supravision excellence with foam layer
Standard	EN 166, EN 170	EN 166, EN 170	EN 166, EN 170	EN 166, EN 170
Frame	transparent grey W 166 34 BT CE	transparent grey W 166 34 BT CE	transparent grey W 166 34 BT CE	transparent grey W 166 34 BT CE
Lens	PC clear UV400 2C-1.2 W1 BTKN CE	PC clear UV400 2C-1.2 W1 BTKN CE	PC clear UV400 2C-1.2 W1 BTKN CE	PC clear UV400 2C-1.2 W1 BTKN CE
Weight	131 g	134 g	131 g	134 g
Order quantity multiples	4 PC	4 PC	4 PC	4 PC

uvex ultravision				
Art. no.	9301813	9301815	9301613	9301633
Replacement lens	9301255	9301255	9301255	9301255
Tear-off films	9300316	-	-	-
Version	uvex supravision excellence with tear-off films, 2 units replacement films: 9300316	uvex supravision excellence top ventilation closed	uvex supravision excellence closed ventilation (gas-proof)	uvex supravision excellence closed ventilation (gas-proof) heat-resistant frame material
Standard	EN 166, EN 170	EN 166, EN 170	EN 166, EN 170	EN 166, EN 170
Frame	transparent grey W 166 34 BT CE	transparent grey W 166 34 BT CE	yellow W 166 345 BT CE	red W 166 345 BT CE
Lens	PC clear UV400 2C-1.2 W1 BTKN CE	PC clear UV400 2C-1.2 W1 BTKN CE	PC clear UV400 2C-1.2 W1 BTKN CE	PC clear UV400 2C-1.2 W1 BTKN CE
Weight	126 g	131 g	133 g	133 g
Order quantity multiples	4 PC	4 PC	4 PC	4 PC

MADE IN GERMANY

Safety Goggles

uvex ultravision faceguard · helmet mounted safety goggles



9301555
Safety Goggle: 9301105



9301317



9301318

uvex ultravision faceguard

- combination of safety goggle with face guard
- protection for eyes and face
- 9301555 or 9301318: Lifting mechanism allows flexible handling during use e.g. communication, drinking, etc.

	Goggles with face protection	Face protection	Face protection
Art. no.	9301555	9301317	9301318
Version	Goggles with uvex supravision excellence (9301105) with faceguard (9301318)	for all models 9301 with PC lens without spectacles uncoated	for all models 9301 with PC lens without spectacles uncoated
Standard	EN 166, EN 170	–	–
Frame	transparent grey W 166 34 BT CE	transparent CE	transparent CE
Lens	PC clear UV400	–	–
	2C-1.2 W1 BTKN CE	–	–
Weight	212 g	64 g	81 g
Order quantity multiples/ Order unit	4 PC	PC	PC



9301544



9924010

Helmet mounted safety goggles uvex ultravision

- safety goggle for combination with helmet and safety earmuffs uvex K1H or uvex K2H (safety earmuffs are not included)
- for attaching the uvex ultravision without safety earmuffs, additional adapters (item no. 9924010) are required

	uvex ultravision	Adapter
Art. no.	9301544	9924010
Replacement lens	–	–
Version	anti-fog on the inside	Adapter for attaching without earmuffs
Standard	EN 166, EN 170	
Frame	transparent grey W 166 34 F CE	
Lens	CA clear UV380	
	2C-1.2 W1 FN CE	
Weight	132 g	–
Order quantity multiples	4 PC	4 PC
Content	–	1 pair

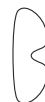

Safety Goggles

uvex 9305 · uvex 9405



9305514



9305714

uvex 9305

- classic safety goggle
- flexible face seal naturally moulds to any facial shape
- internal volume comfortably accommodates prescription spectacles
- indirect ventilation system increases air circulation
- length-adjustable textile or rubber headband for a secure fit and individual adaptability
- cellulose acetate lens with anti-fog performance on the inside and UV380 protection
- metal-free

uvex 9305		
Art. no.	9305514	9305714
Version	anti-fog on the inside with rubber headband	anti-fog on the inside with textile headband
Standard	EN 166, EN 170	EN 166, EN 170
Frame	transparent grey	transparent grey
Lens	W 166 34 F CE	W 166 34 F CE
	CA clear	CA clear
	UV380	UV380
	2C-1.2 W1 FN CE	2C-1.2 W1 FN CE
Weight	95 g	91 g
Order quantity multiples	4 PC	4 PC



9405714

uvex 9405

- classic safety goggle
- flexible face seal naturally moulds to any facial shape
- internal volume comfortably accommodates prescription spectacles
- indirect ventilation system increases air circulation
- length-adjustable textile headband for a secure fit and individual adaptability
- cellulose acetate lens with anti-fog performance on the inside and UV380 protection
- metal-free

uvex 9405	
Art. no.	9405714
Version	anti-fog on the inside
Standard	EN 166, EN 170
Frame	transparent grey
	W 166 34 F CE
Lens	CA clear
	UV380
	2C-1.2 W1 FN CE
Weight	84 g
Order quantity multiples	4 PC

Infrared protection uvex IR-ex safety spectacles

Preventive protection against infrared radiation

Infrared radiation (IR radiation) is also referred to as heat radiation, as it is perceived as such.

Strictly speaking, heat radiation ranges from infrared to visible light (VIS) up to ultraviolet (UV) – depending on the temperature.

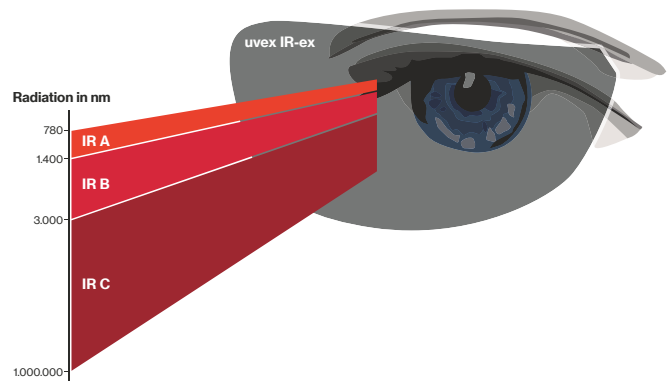
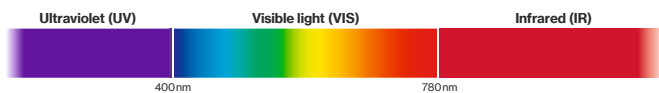

IR radiation cannot be perceived by the human eye. It extends over the electromagnetic spectrum from 780 nm to 1 mm (1,000,000 nm).

IR radiation is divided into three spectra:

- IR A (780 nm–1400 nm)
- IR B (1400 nm–3000 nm)
- IR C (3000 nm–1 mm)

The invisible danger

The effect of infrared radiation on human tissue can be harmful.

Since it is not immediately noticeable, infrared radiation can increase the risk of permanent eye damage, such as cataracts.

Principle: The greater the wavelength, the lower the penetration depth into the tissue.

Caution: For applications requiring prolonged or repeated viewing of glowing objects, it is **essential** that suitable safety eyewear be worn.

uvex IR-ex safety spectacles

100% **UV400** protection

Durable **uvex supravision coating:**
K – extremely scratch-resistant on the outside
N – permanently anti-fog on the inside

Additional T certification on lens and side arm
Mechanical strength F at extreme temperatures



Multi-standard compliant:
EN171, EN169, JIS T8141, ANSI/ISEA Z87.1

Available in **three protection levels 1.7/3/5**



Maximum high transmission in visible spectrum

Levels of infrared protection and recommendations for use according to EN 171

Level of protection	Recommended use in accordance with EN 171
4-1.7	average temperature of the radiation source up to 1090°C*
4-2	average temperature of the radiation source up to 1110°C (forges)
4-3	average temperature of the radiation source 1190°C (glass blowing)*
4-4	average temperature of the radiation source 1290°C (foundries)
4-5	average temperature of the radiation source 1390°C (steel foundries)*
4-6	average temperature of the radiation source 1510°C (iron foundries)



You can find more information at uvex-safety.com/ir-ex



Infrared protection

uvex pheos cx2 · uvex super f OTG



9198171



9198173



9198175

uvex pheos cx2

- sporty-looking safety spectacles with high wearer acceptance
- x-tended eyeshield: soft seal frame technology wraps around the brow providing protection from particle ingress
- ergonomically shaped side arms with soft-grip temple ends provide a comfortable, secure fit without pressure
- soft, flexible nose pad adapts to the wearer, delivering a non-slip and pressure-free fit
- robust polycarbonate lens with uvex's proven infraradur coating technology – permanent anti-fog and scratch-resistant lens
- IR protection according to EN 171 and welding protection according to EN 169 with perfect colour recognition
- UV400 – 100% protection against dangerous UV radiation up to 400 nm
- metal-free

uvex pheos cx2			
Art. no.	9198171	9198173	9198175
Version	uvex infradur plus	uvex infradur plus	uvex infradur plus
Standard	Infrared protection level 1.7	Infrared protection level 3	Infrared protection level 5
Frame	EN 166, EN 171, EN 169, EN 170	EN 166, EN 171, EN 169, EN 170	EN 166, EN 171, EN 169, EN 170
Lens	black, red	black, red	black, red
Weight	W 166 FT CE	W 166 FT CE	W 166 FT CE
Order quantity multiples	PC grey IR-ex 1.7	PC grey IR-ex 3	PC grey IR-ex 5
	UV400 + IR	UV400 + IR	UV400 + IR
	4C-1.7 W1 FTKN CE	4C-3 W1 FTKN CE	4C-5 W1 FTKN CE
	1.7 W1 FTKN CE	3 W1 FTKN CE	5 W1 FTKN CE
	2C-1.7 W1 FTKN CE	2C-3 W1 FTKN CE	2C-5 W1 FTKN CE
	28 g	28 g	28 g
	10 PC	10 PC	10 PC



9169171



9169173



9169175

uvex super f OTG

- classic overspecs for prescription spectacle wearers with a flat lens for a wide field of vision, designed for maximum wearer acceptance
- side arms with soft-grip temple ends provide a comfortable, secure fit without pressure
- nose bridge designed for all-day comfort
- robust polycarbonate lens with uvex's proven infradur coating technology – permanent anti-fog and scratch-resistant lens
- IR protection according to EN 171 and welding protection according to EN 169 with perfect colour recognition
- UV400 – 100% protection against dangerous UV radiation up to 400 nm

uvex super f OTG			
Art. no.	9169171	9169173	9169175
Version	uvex infradur plus	uvex infradur plus	uvex infradur plus
Standard	Infrared protection level 1.7	Infrared protection level 3	Infrared protection level 5
Frame	EN 166, EN 171, EN 169, EN 170	EN 166, EN 171, EN 169, EN 170	EN 166, EN 171, EN 169, EN 170
Lens	black, red	black, red	black, red
Weight	W 166 FT CE	W 166 FT CE	W 166 FT CE
Order quantity multiples	PC grey IR-ex 1.7	PC grey IR-ex 3	PC grey IR-ex 5
	UV400 + IR	UV400 + IR	UV400 + IR
	4C-1.7 W1 FTKN CE	4C-3 W1 FTKN CE	4C-5 W1 FTKN CE
	1.7 W1 FTKN CE	3 W1 FTKN CE	5 W1 FTKN CE
	2C-1.7 W1 FTKN CE	2C-3 W1 FTKN CE	2C-5 W1 FTKN CE
	39 g	39 g	39 g
	8 PC	8 PC	8 PC

Welding Protection

A new generation of welding protection eyewear available with different grey-tint lenses and protection classes. The innovative technology affords protection from UV and infrared light while maintaining perfect colour recognition in line with uvex sunglare filters.

The special uvex infradur plus coating has anti-fog properties which prevents the inside of the lenses misting up and the extreme scratch-resistance on the outside keeps damage from welding sparks to an absolute minimum.

With various welding safety spectacles and goggle solutions, there is something for everyone – enhancing comfort and the wearer experience.

N.B.: Do not use for electric welding.

All welding products have polycarbonate lenses providing protection against impact as well as UV rays, IR rays and visible glare.

The products do not provide protection against laser beams!

For expert advice on safety and in selecting the right laser protection eyewear, talk to our specialists

laservision

Call them on +49 (0)911 9736 8100.

uvex-laservision.com



New grey tint offers increased impact protection than traditional green welding tint products

IR/UV filter for improved safety

Sun/glare protection filters

Perfect colour recognition

Marking K and N for uvex infradur plus coated lenses



Levels of welding protection and recommendations for use according to EN 169

Level of protection	Use
1.7	For welding assistants, protection against UV radiation and bright scattered light
2	Lightweight oxyacetylene cutting
3	Flame derusting, flame cutting, lightweight oxyacetylene cutting
4	Welding and hard soldering with up to 70 l/h of acetylene, flame cutting with up to 900 l/h of oxygen, steel and grey cast iron welding, lightweight oxyacetylene cutting
5	Welding and hard soldering with 70 to 200 l/h of acetylene, flame cutting with 2000 to 4000 l/h of oxygen
6	Welding and hard soldering with 200 to 800 l/h of acetylene, flame cutting with 2000 to 4000 l/h of oxygen



Welding Protection

uvex i-5 · uvex super f OTG



9183041



9183043



9183145

uvex i-5

- sporty premium quality welding safety spectacle with a range of adaptive features
- x-tended eyeshield: soft seal frame technology wraps around the brow providing protection from particle ingress
- x-tended sideshield offers additional protection from hazards
- ergonomically shaped side arms with multi-incline points and length adjustment allow a high level of individualisation to ensure a good fit for all facial shapes and head widths
- soft-grip temple ends provide a comfortable, secure fit without pressure
- soft, flexible nose pad adapts to the wearer, delivering a non-slip and pressure-free fit
- robust polycarbonate lens with uvex's proven infraradur coating technology – permanent anti-fog and scratch-resistant lens
- IR protection according to EN 169 with perfect colour recognition according to EN 172
- UV400 – 100% protection against dangerous UV radiation up to 400 nm
- optional clip-in frame seal provides extra protection against particles, dirt and dust
- metal-free

uvex i-5			
Art. no.	9183041	9183043	9183045
Version	uvex infradur plus welding protection level 1.7	uvex infradur plus welding protection level 3	uvex infradur plus welding protection level 5
Standard	EN 166, EN 169	EN 166, EN 169	EN 166, EN 169
Frame	black, green W 166 FT CE	black, green W 166 FT CE	black, green W 166 FT CE
Lens	PC grey UV400 + IR 1.7 W1 FTKN CE	PC grey UV400 + IR 3 W1 FTKN CE	PC grey UV400 + IR 5 W1 FTKN CE
Weight	29 g	29 g	29 g
Order quantity multiples	10 PC	10 PC	10 PC



9169541



9169543



9169545

uvex super f OTG

- classic welding overspecs for prescription spectacle wearers with a flat lens for wide field of vision, designed for maximum wearer acceptance
- side arms with soft-grip temple ends provide a comfortable, secure fit without pressure
- nose bridge designed for all-day comfort
- robust polycarbonate lens with uvex's proven infradur coating technology – permanent anti-fog and scratch-resistant lens
- IR protection according to EN 169 with perfect colour recognition according to EN 172
- UV400 – 100% protection against dangerous UV radiation up to 400 nm

uvex super f OTG			
Art. no.	9169541	9169543	9169545
Version	uvex infradur plus welding protection level 1.7	uvex infradur plus welding protection level 3	uvex infradur plus welding protection level 5
Standard	EN 166, EN 169	EN 166, EN 169	EN 166, EN 169
Frame	black, green W 166 FT CE	black, green W 166 FT CE	black, green W 166 FT CE
Lens	PC grey UV400 + IR 1.7 W1 FTKN CE	PC grey UV400 + IR 3 W1 FTKN CE	PC grey UV400 + IR 5 W1 FTKN CE
Weight	39 g	39 g	39 g
Order quantity multiples	8 PC	8 PC	8 PC

MADE IN GERMANY

Welding Protection

uvex megasonic · uvex ultrasonic



9320045

uvex megasonic

- functional welding safety goggle in a ski goggle design and a truly panoramic field of vision
- unique frameless lens design for edge-to-edge optical clarity and increased safety
- soft, adaptive face seal providing a universal fit for different head and face shapes as well as a tight fit without pressure points
- generous internal volume to accommodate prescription eyewear and frame recesses to locate the side arms ensuring a comfortable fit
- indirect ventilation system increases air circulation
- length-adjustable 30 mm wide textile headband
- robust polycarbonate lens with uvex's proven infradur coating technology – permanent anti-fog and scratch-resistant lens
- IR protection according to EN 169 with perfect colour recognition according to EN 172
- UV400 – 100% protection against dangerous UV radiation up to 400 nm
- metal-free

uvex megasonic	
Art. no.	9320045
Version	uvex infradur plus welding protection level 5
Standard	EN 166, EN 169
Frame	black
	W 166 34 BT CE
Lens	PC grey UV400 + IR 5 W1 BTKN CE
Weight	96 g
Order quantity multiples	4 PC



9302045

uvex ultrasonic

- functional welding safety goggle with panoramic and flip-up lens for an increased use of applications
- soft, flexible face seal naturally moulds to any facial shape
- generous internal volume to accommodate prescription spectacles and ensure a comfortable fit
- indirect ventilation system increases air circulation
- length-adjustable textile headband for a secure fit and individual adaptability
- robust polycarbonate lens with uvex's proven supravision and infradur coating technology – permanent anti-fog and scratch-resistant lens
- IR protection according to EN 169 with perfect colour recognition according to EN 172
- UV400 – 100% protection against dangerous UV radiation up to 400 nm
- a sustainable benefit: lenses can be replaced when required
- metal-free

uvex ultrasonic	
Art. no.	9302045
Replacement lens flip-up	9302085
Version	uvex supravision excellence with flip-up and easily replaceable filter
Standard	EN 166, EN 169, EN 170
Frame	black, green
Lens	W 166 34 B CE PC clear, UV400
Additional lens	2C-1.2 W1 BKN CE PC grey, UV400 + IR uvex infradur, 5 W1 CE welding protection level 5
Weight	123 g
Order quantity multiples	4 PC



Accessories

uvex cleaning accessories · Presentation



9970005



9972101



9963005

uvex eyewear cleaning station

- including
2 x 9971000
1 x 9972103
1 x 9973101

Plastic pump

- for uvex cleaning fluid 9972103

uvex cleaning fluid

- 500 ml cleaning fluid
- suitable for all uvex lenses

Cleaning paper

- replacement pack silicone-free paper
- approx. 760 sheets
- antistatic
- suitable for all uvex lenses

Magnetic wall bracket

- for easy mounting of the uvex cleaning station (9970005)

uvex eyewear cleaning station	
Art. no.	9970005
Order unit	PC

Plastic pump	
Art. no.	9973101
Order unit	PC

uvex cleaning fluid	
Art. no.	9972103
Content	500 ml
Order unit	PC

Cleaning papers	
Art. no.	9971000
Order unit	PC

Magnetic wall bracket	
Art. no.	9963004
Order unit	PC

uvex cleaning fluid

- 500 ml cleaning fluid
- suitable for all uvex lenses
- Note: does not fit in the cleaning stations (9970005 and 9970002).

uvex cleaning fluid	
Art. no.	9972101
Content	500 ml
Order unit	PC

uvex lens cleaning towelettes

- 100 towelettes per box
- individually packed
- silicone-free
- not antistatic
- suitable for all uvex lenses

uvex cleaning towelettes	
Art. no.	9963005
Order unit	PC



9972130



9957503

uvex microfibre cloth

- suitable for cleaning all uvex lenses

uvex microfibre cloth	
Art. no.	9972130
Order unit	BG
Content	5 PC

uvex display

- with integrated mirror
- for four safety spectacles and one safety goggle

uvex Display	
Art. no.	9957503
Order unit	PC

Accessories

Storage



9954600



9954500



9954501

uvex eyewear case

- extremely robust hard case for protection against external influences
- soft embedded inside
- with belt loop
- practical snap hook
- especially suitable for curved safety eyewear (e.g. uvex i-vo)

uvex eyewear case

- robust case
- additional space for spare lens
- reinforced zipper
- with belt loop
- suitable for all uvex safety spectacles

uvex eyewear case

- large and robust case
- additional space for spare lens
- with belt loop
- suitable for all uvex safety spectacles and goggles

uvex eyewear case			
Art. no.	9954600	9954500	9954501
Order quantity multiples	10 PC	10 PC	10 PC



9954355



9954395



9954360

uvex microfibre bag

- elegant microfibre bag
- suitable for all uvex safety spectacles and safety overspecs

uvex microfibre bag

- elegant microfibre bag
- suitable for all uvex safety spectacles and safety overspecs
- made from 100% recycled PET bottles

uvex microfibre bag

- elegant microfibre bag
- suitable for all uvex safety overspecs and safety goggles

uvex microfibre bag		uvex planet microfibre bag		uvex microfibre bag	
Art. no.	9954355	9954395	9954395	9954360	9954360
Order quantity multiples	10 PC	10 PC	10 PC	10 PC	10 PC



6118002

uvex eyewear case

- flexible case made of robust nylon material
- Velcro fastener individually adjustable
- extendable by zipper on the side
- with belt loop
- suitable for all uvex safety spectacles



9957502

uvex SECU box

- storage box for wall mounting
- for spectacles and goggles: 2 safety goggles or 3 safety spectacles or 1 safety goggles and 2 safety spectacles

uvex eyewear case		uvex SECU box	
Art. no.	6118002	Art. no.	9957502
Order unit	10 PC	Order unit	PC



Accessories

uvex hang-cords · uvex headband



9958017

uvex eyewear cord

- individual length adjustment
- for compatibility with uvex models please see overview on p. 74



9958030

uvex eyewear cord

- individual length adjustment
- for compatibility with uvex models please see overview on p. 74
- made from 100% recycled PET bottles



9959002

uvex eyewear cord

- suitable for all uvex safety spectacles

uvex eyewear cord		uvex planet eyewear cord		uvex eyewear cord	
Art. no.	9958017	9958030		9959002	
Order quantity multiples	10 PC	10 PC		10 PC	

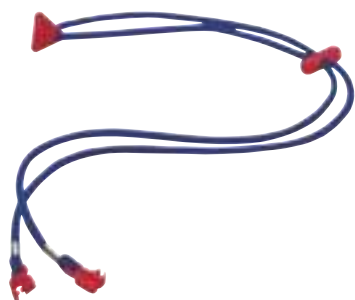

9959003

uvex eyewear cord

- individual length adjustment
- for compatibility with uvex models please see overview on p. 74



9959004

uvex eyewear cord

- individual length adjustment
- metal-free
- for compatibility with uvex models please see overview on p. 74

uvex eyewear cord		uvex eyewear cord	
Art. no.	9959003	9959004	
Order quantity multiples	10 ST	ST	



9958020

uvex pheos headband

- headband for uvex pheos and uvex pheos s (see p. 43, 74)
- individual length adjustment
- metal-free

















9958023

uvex x-fit headband

- headband for uvex x-fit und uvex x-fit pro (see p. 39, 74)
- individual length adjustment
- metal-free

uvex pheos headband		uvex x-fit / uvex x-fit pro headband	
Art. no.	9958020	9958023	
Order quantity multiples	10 PC	PC	

Cord/case matrix

Model	Name	Cords/straps							Cases							
																
		9958017	9958030	9958020 (pheos/ pheos s)	9959003	9959004	9959002	9958023 (x-fit family)	9954600	9954500	9954501	6118002	9954355	9954395	9954360	9957502 SECU-Box
9128	uvex pheos nxt	<input type="checkbox"/>	<input type="checkbox"/>	<input type="checkbox"/>	<input checked="" type="checkbox"/>	<input checked="" type="checkbox"/>	<input checked="" type="checkbox"/>	<input type="checkbox"/>	<input checked="" type="checkbox"/>	<input checked="" type="checkbox"/>	<input checked="" type="checkbox"/>	<input checked="" type="checkbox"/>	<input checked="" type="checkbox"/>	<input checked="" type="checkbox"/>	<input checked="" type="checkbox"/>	<input checked="" type="checkbox"/>
9134	uvex meteor	<input type="checkbox"/>	<input type="checkbox"/>	<input type="checkbox"/>	<input checked="" type="checkbox"/>	<input checked="" type="checkbox"/>	<input checked="" type="checkbox"/>	<input type="checkbox"/>	<input checked="" type="checkbox"/>	<input checked="" type="checkbox"/>	<input checked="" type="checkbox"/>	<input checked="" type="checkbox"/>	<input checked="" type="checkbox"/>	<input checked="" type="checkbox"/>	<input checked="" type="checkbox"/>	<input checked="" type="checkbox"/>
9137	uvex ceramic	<input checked="" type="checkbox"/>	<input checked="" type="checkbox"/>	<input type="checkbox"/>	<input type="checkbox"/>	<input type="checkbox"/>	<input checked="" type="checkbox"/>	<input type="checkbox"/>	<input checked="" type="checkbox"/>	<input checked="" type="checkbox"/>	<input checked="" type="checkbox"/>	<input checked="" type="checkbox"/>	<input checked="" type="checkbox"/>	<input checked="" type="checkbox"/>	<input checked="" type="checkbox"/>	<input checked="" type="checkbox"/>
9143	uvex i-lite	<input checked="" type="checkbox"/>	<input checked="" type="checkbox"/>	<input type="checkbox"/>	<input checked="" type="checkbox"/>	<input checked="" type="checkbox"/>	<input checked="" type="checkbox"/>	<input type="checkbox"/>	<input checked="" type="checkbox"/>	<input checked="" type="checkbox"/>	<input checked="" type="checkbox"/>	<input checked="" type="checkbox"/>	<input checked="" type="checkbox"/>	<input checked="" type="checkbox"/>	<input checked="" type="checkbox"/>	<input checked="" type="checkbox"/>
9143	uvex i-guard	<input checked="" type="checkbox"/>	<input checked="" type="checkbox"/>	<input type="checkbox"/>	<input checked="" type="checkbox"/>	<input checked="" type="checkbox"/>	<input checked="" type="checkbox"/>	<input type="checkbox"/>	<input checked="" type="checkbox"/>	<input checked="" type="checkbox"/>	<input checked="" type="checkbox"/>	<input checked="" type="checkbox"/>	<input checked="" type="checkbox"/>	<input checked="" type="checkbox"/>	<input checked="" type="checkbox"/>	<input checked="" type="checkbox"/>
9143	uvex i-guard+	<input type="checkbox"/>	<input type="checkbox"/>	<input type="checkbox"/>	<input type="checkbox"/>	<input type="checkbox"/>	<input type="checkbox"/>	<input type="checkbox"/>	<input checked="" type="checkbox"/>	<input checked="" type="checkbox"/>	<input checked="" type="checkbox"/>	<input checked="" type="checkbox"/>	<input checked="" type="checkbox"/>	<input checked="" type="checkbox"/>	<input checked="" type="checkbox"/>	<input checked="" type="checkbox"/>
9145	uvex pure-fit	<input checked="" type="checkbox"/>	<input checked="" type="checkbox"/>	<input type="checkbox"/>	<input type="checkbox"/>	<input type="checkbox"/>	<input checked="" type="checkbox"/>	<input type="checkbox"/>	<input type="checkbox"/>	<input checked="" type="checkbox"/>	<input checked="" type="checkbox"/>	<input checked="" type="checkbox"/>	<input checked="" type="checkbox"/>	<input checked="" type="checkbox"/>	<input checked="" type="checkbox"/>	<input checked="" type="checkbox"/>
9155	uvex mercury	<input checked="" type="checkbox"/>	<input checked="" type="checkbox"/>	<input type="checkbox"/>	<input type="checkbox"/>	<input type="checkbox"/>	<input checked="" type="checkbox"/>	<input type="checkbox"/>	<input type="checkbox"/>	<input checked="" type="checkbox"/>	<input checked="" type="checkbox"/>	<input checked="" type="checkbox"/>	<input checked="" type="checkbox"/>	<input checked="" type="checkbox"/>	<input checked="" type="checkbox"/>	<input checked="" type="checkbox"/>
9159	uvex winner	<input checked="" type="checkbox"/>	<input checked="" type="checkbox"/>	<input type="checkbox"/>	<input type="checkbox"/>	<input type="checkbox"/>	<input checked="" type="checkbox"/>	<input type="checkbox"/>	<input checked="" type="checkbox"/>	<input checked="" type="checkbox"/>	<input checked="" type="checkbox"/>	<input checked="" type="checkbox"/>	<input checked="" type="checkbox"/>	<input checked="" type="checkbox"/>	<input checked="" type="checkbox"/>	<input checked="" type="checkbox"/>
9160	uvex i-vo	<input type="checkbox"/>	<input type="checkbox"/>	<input type="checkbox"/>	<input checked="" type="checkbox"/>	<input checked="" type="checkbox"/>	<input checked="" type="checkbox"/>	<input type="checkbox"/>	<input checked="" type="checkbox"/>	<input checked="" type="checkbox"/>	<input checked="" type="checkbox"/>	<input checked="" type="checkbox"/>	<input checked="" type="checkbox"/>	<input checked="" type="checkbox"/>	<input checked="" type="checkbox"/>	<input checked="" type="checkbox"/>
9161	uvex 9161	<input type="checkbox"/>	<input type="checkbox"/>	<input type="checkbox"/>	<input type="checkbox"/>	<input type="checkbox"/>	<input checked="" type="checkbox"/>	<input type="checkbox"/>	<input type="checkbox"/>	<input checked="" type="checkbox"/>	<input checked="" type="checkbox"/>	<input checked="" type="checkbox"/>	<input checked="" type="checkbox"/>	<input checked="" type="checkbox"/>	<input checked="" type="checkbox"/>	<input checked="" type="checkbox"/>
9164	uvex astrospec 2.0	<input checked="" type="checkbox"/>	<input checked="" type="checkbox"/>	<input type="checkbox"/>	<input checked="" type="checkbox"/>	<input checked="" type="checkbox"/>	<input checked="" type="checkbox"/>	<input type="checkbox"/>	<input checked="" type="checkbox"/>	<input checked="" type="checkbox"/>	<input checked="" type="checkbox"/>	<input checked="" type="checkbox"/>	<input checked="" type="checkbox"/>	<input checked="" type="checkbox"/>	<input checked="" type="checkbox"/>	<input checked="" type="checkbox"/>
9169	uvex super OTG	<input checked="" type="checkbox"/>	<input checked="" type="checkbox"/>	<input type="checkbox"/>	<input type="checkbox"/>	<input type="checkbox"/>	<input checked="" type="checkbox"/>	<input type="checkbox"/>	<input type="checkbox"/>	<input checked="" type="checkbox"/>	<input checked="" type="checkbox"/>	<input checked="" type="checkbox"/>	<input checked="" type="checkbox"/>	<input checked="" type="checkbox"/>	<input checked="" type="checkbox"/>	<input checked="" type="checkbox"/>
9169	uvex super f OTG	<input checked="" type="checkbox"/>	<input checked="" type="checkbox"/>	<input type="checkbox"/>	<input type="checkbox"/>	<input type="checkbox"/>	<input checked="" type="checkbox"/>	<input type="checkbox"/>	<input type="checkbox"/>	<input checked="" type="checkbox"/>	<input checked="" type="checkbox"/>	<input checked="" type="checkbox"/>	<input checked="" type="checkbox"/>	<input checked="" type="checkbox"/>	<input checked="" type="checkbox"/>	<input checked="" type="checkbox"/>
9172	uvex super g	<input checked="" type="checkbox"/>	<input checked="" type="checkbox"/>	<input type="checkbox"/>	<input type="checkbox"/>	<input type="checkbox"/>	<input checked="" type="checkbox"/>	<input type="checkbox"/>	<input checked="" type="checkbox"/>	<input checked="" type="checkbox"/>	<input checked="" type="checkbox"/>	<input checked="" type="checkbox"/>	<input checked="" type="checkbox"/>	<input checked="" type="checkbox"/>	<input checked="" type="checkbox"/>	<input checked="" type="checkbox"/>
9178	uvex super fit	<input checked="" type="checkbox"/>	<input checked="" type="checkbox"/>	<input type="checkbox"/>	<input type="checkbox"/>	<input type="checkbox"/>	<input checked="" type="checkbox"/>	<input type="checkbox"/>	<input checked="" type="checkbox"/>	<input checked="" type="checkbox"/>	<input checked="" type="checkbox"/>	<input checked="" type="checkbox"/>	<input checked="" type="checkbox"/>	<input checked="" type="checkbox"/>	<input checked="" type="checkbox"/>	<input checked="" type="checkbox"/>
9181	uvex suXXeed	<input checked="" type="checkbox"/>	<input checked="" type="checkbox"/>	<input type="checkbox"/>	<input type="checkbox"/>	<input type="checkbox"/>	<input checked="" type="checkbox"/>	<input type="checkbox"/>	<input checked="" type="checkbox"/>	<input checked="" type="checkbox"/>	<input checked="" type="checkbox"/>	<input checked="" type="checkbox"/>	<input checked="" type="checkbox"/>	<input checked="" type="checkbox"/>	<input checked="" type="checkbox"/>	<input checked="" type="checkbox"/>
9183	uvex i-5	<input checked="" type="checkbox"/>	<input checked="" type="checkbox"/>	<input type="checkbox"/>	<input type="checkbox"/>	<input type="checkbox"/>	<input checked="" type="checkbox"/>	<input type="checkbox"/>	<input checked="" type="checkbox"/>	<input checked="" type="checkbox"/>	<input checked="" type="checkbox"/>	<input checked="" type="checkbox"/>	<input checked="" type="checkbox"/>	<input checked="" type="checkbox"/>	<input checked="" type="checkbox"/>	<input checked="" type="checkbox"/>
9190	uvex i-3 / i-3 s	<input checked="" type="checkbox"/>	<input checked="" type="checkbox"/>	<input type="checkbox"/>	<input type="checkbox"/>	<input type="checkbox"/>	<input checked="" type="checkbox"/>	<input type="checkbox"/>	<input checked="" type="checkbox"/>	<input checked="" type="checkbox"/>	<input checked="" type="checkbox"/>	<input checked="" type="checkbox"/>	<input checked="" type="checkbox"/>	<input checked="" type="checkbox"/>	<input checked="" type="checkbox"/>	<input checked="" type="checkbox"/>
9192	uvex pheos / pheos s	<input checked="" type="checkbox"/>	<input checked="" type="checkbox"/>	<input checked="" type="checkbox"/>	<input checked="" type="checkbox"/>	<input checked="" type="checkbox"/>	<input checked="" type="checkbox"/>	<input type="checkbox"/>	<input checked="" type="checkbox"/>	<input checked="" type="checkbox"/>	<input checked="" type="checkbox"/>	<input checked="" type="checkbox"/>	<input checked="" type="checkbox"/>	<input checked="" type="checkbox"/>	<input checked="" type="checkbox"/>	<input checked="" type="checkbox"/>
9192	uvex pheos guard / s	<input type="checkbox"/>	<input type="checkbox"/>	<input checked="" type="checkbox"/>	<input type="checkbox"/>	<input type="checkbox"/>	<input type="checkbox"/>	<input type="checkbox"/>	<input checked="" type="checkbox"/>	<input checked="" type="checkbox"/>	<input checked="" type="checkbox"/>	<input checked="" type="checkbox"/>	<input checked="" type="checkbox"/>	<input checked="" type="checkbox"/>	<input checked="" type="checkbox"/>	<input checked="" type="checkbox"/>
9193	uvex sportstyle	<input checked="" type="checkbox"/>	<input checked="" type="checkbox"/>	<input type="checkbox"/>	<input type="checkbox"/>	<input type="checkbox"/>	<input checked="" type="checkbox"/>	<input type="checkbox"/>	<input checked="" type="checkbox"/>	<input checked="" type="checkbox"/>	<input checked="" type="checkbox"/>	<input checked="" type="checkbox"/>	<input checked="" type="checkbox"/>	<input checked="" type="checkbox"/>	<input checked="" type="checkbox"/>	<input checked="" type="checkbox"/>
9194	uvex i-works	<input checked="" type="checkbox"/>	<input checked="" type="checkbox"/>	<input type="checkbox"/>	<input checked="" type="checkbox"/>	<input checked="" type="checkbox"/>	<input checked="" type="checkbox"/>	<input type="checkbox"/>	<input checked="" type="checkbox"/>	<input checked="" type="checkbox"/>	<input checked="" type="checkbox"/>	<input checked="" type="checkbox"/>	<input checked="" type="checkbox"/>	<input checked="" type="checkbox"/>	<input checked="" type="checkbox"/>	<input checked="" type="checkbox"/>
9198	uvex pheos cx2	<input type="checkbox"/>	<input type="checkbox"/>	<input type="checkbox"/>	<input type="checkbox"/>	<input type="checkbox"/>	<input checked="" type="checkbox"/>	<input type="checkbox"/>	<input checked="" type="checkbox"/>	<input checked="" type="checkbox"/>	<input checked="" type="checkbox"/>	<input checked="" type="checkbox"/>	<input checked="" type="checkbox"/>	<input checked="" type="checkbox"/>	<input checked="" type="checkbox"/>	<input checked="" type="checkbox"/>
9199	uvex x-fit	<input checked="" type="checkbox"/>	<input checked="" type="checkbox"/>	<input type="checkbox"/>	<input type="checkbox"/>	<input checked="" type="checkbox"/>	<input checked="" type="checkbox"/>	<input checked="" type="checkbox"/>	<input checked="" type="checkbox"/>	<input checked="" type="checkbox"/>	<input checked="" type="checkbox"/>	<input checked="" type="checkbox"/>	<input checked="" type="checkbox"/>	<input checked="" type="checkbox"/>	<input checked="" type="checkbox"/>	<input checked="" type="checkbox"/>
9199	uvex x-fit pro	<input type="checkbox"/>	<input type="checkbox"/>	<input type="checkbox"/>	<input type="checkbox"/>	<input checked="" type="checkbox"/>	<input checked="" type="checkbox"/>	<input checked="" type="checkbox"/>	<input checked="" type="checkbox"/>	<input checked="" type="checkbox"/>	<input checked="" type="checkbox"/>	<input checked="" type="checkbox"/>	<input checked="" type="checkbox"/>	<input checked="" type="checkbox"/>	<input checked="" type="checkbox"/>	<input checked="" type="checkbox"/>
9231	uvex polavision	<input checked="" type="checkbox"/>	<input checked="" type="checkbox"/>	<input type="checkbox"/>	<input type="checkbox"/>	<input type="checkbox"/>	<input checked="" type="checkbox"/>	<input type="checkbox"/>	<input checked="" type="checkbox"/>	<input checked="" type="checkbox"/>	<input checked="" type="checkbox"/>	<input checked="" type="checkbox"/>	<input checked="" type="checkbox"/>	<input checked="" type="checkbox"/>	<input checked="" type="checkbox"/>	<input checked="" type="checkbox"/>
9301	uvex ultravision	<input type="checkbox"/>	<input type="checkbox"/>	<input type="checkbox"/>	<input type="checkbox"/>	<input type="checkbox"/>	<input type="checkbox"/>	<input type="checkbox"/>	<input type="checkbox"/>	<input type="checkbox"/>	<input checked="" type="checkbox"/>	<input type="checkbox"/>	<input type="checkbox"/>	<input type="checkbox"/>	<input type="checkbox"/>	<input checked="" type="checkbox"/>
9302	uvex ultrasonic	<input type="checkbox"/>	<input type="checkbox"/>	<input type="checkbox"/>	<input type="checkbox"/>	<input type="checkbox"/>	<input type="checkbox"/>	<input type="checkbox"/>	<input type="checkbox"/>	<input type="checkbox"/>	<input checked="" type="checkbox"/>	<input type="checkbox"/>	<input type="checkbox"/>	<input type="checkbox"/>	<input type="checkbox"/>	<input checked="" type="checkbox"/>
9305	uvex 9305	<input type="checkbox"/>	<input type="checkbox"/>	<input type="checkbox"/>	<input type="checkbox"/>	<input type="checkbox"/>	<input type="checkbox"/>	<input type="checkbox"/>	<input type="checkbox"/>	<input type="checkbox"/>	<input checked="" type="checkbox"/>	<input type="checkbox"/>	<input type="checkbox"/>	<input type="checkbox"/>	<input type="checkbox"/>	<input checked="" type="checkbox"/>
9309	uvex pheos cx2 sonic	<input type="checkbox"/>	<input type="checkbox"/>	<input type="checkbox"/>	<input type="checkbox"/>	<input type="checkbox"/>	<input type="checkbox"/>	<input type="checkbox"/>	<input checked="" type="checkbox"/>	<input checked="" type="checkbox"/>	<input checked="" type="checkbox"/>	<input checked="" type="checkbox"/>	<input checked="" type="checkbox"/>	<input checked="" type="checkbox"/>	<input checked="" type="checkbox"/>	<input checked="" type="checkbox"/>
9320	uvex megasonic	<input type="checkbox"/>	<input type="checkbox"/>	<input type="checkbox"/>	<input type="checkbox"/>	<input type="checkbox"/>	<input type="checkbox"/>	<input type="checkbox"/>	<input type="checkbox"/>	<input type="checkbox"/>	<input checked="" type="checkbox"/>	<input type="checkbox"/>	<input type="checkbox"/>	<input type="checkbox"/>	<input type="checkbox"/>	<input checked="" type="checkbox"/>
9405	uvex 9405	<input type="checkbox"/>	<input type="checkbox"/>	<input type="checkbox"/>	<input type="checkbox"/>	<input type="checkbox"/>	<input type="checkbox"/>	<input type="checkbox"/>	<input type="checkbox"/>	<input type="checkbox"/>	<input checked="" type="checkbox"/>	<input type="checkbox"/>	<input type="checkbox"/>	<input type="checkbox"/>	<input type="checkbox"/>	<input checked="" type="checkbox"/>

2 goggles or 3-4 spectacles
or 1 goggles + 2 spectacles

compatible not compatible

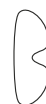

Applications

Always the perfect solution

Working conditions	Eyewear model	Lens material	Lens tint	Lens coating
Light and precision engineering	Spectacles	PC	clear	uvex supravision AR (anti-reflet) uvex supravision excellence
Assembly, maintenance	Spectacles	PC	clear	uvex supravision excellence
Grinding, angle grinding	Spectacles Goggles	PC	clear	uvex supravision excellence uvex supravision extreme
Turning, milling	Spectacles	PC	clear	uvex supravision excellence
Dusty environments	Goggles	PC	clear	uvex supravision excellence uvex supravision extreme
Foundry cleaning	Goggles	PC	clear	uvex supravision excellence uvex supravision extreme
Forestry and agriculture	Spectacles	PC	clear amber grey 23 %	uvex supravision excellence uvex supravision extreme
Laboratory	Spectacles Goggles	PC CA	clear	uvex supravision sapphire uvex supravision excellence
Working with acids and galvanic media	Goggles	PC CA	clear	uvex supravision excellence uvex supravision extreme
Mixed lighting	Spectacles	PC	clear	uvex supravision AR (anti-reflet)
Strong lighting, glare	Spectacles	PC	CBR65 silver mirror 53 %	uvex supravision excellence uvex supravision extreme
Outdoors – sunglare	Spectacles	PC	grey CBR23 silver mirror	uvex supravision excellence uvex supravision extreme
Offshoring / maritime	Spectacles	PC	variomatic polavision	uvex supravision variomatic uvex polavision
Spot welding, soldering oxygene cutting gas welding, braze welding Welders assistant foundries furnaces	Spectacles Goggles	PC	welding shade	uvex infradur uvex infradur plus
Forging Glass blowing Metal melting Working with red-hot media Working with industrial infrared drying Short-term use at a medium distance	Spectacles Overspecs	PC	Infrared protection	uvex infradur plus
Sterile working conditions	Spectacles Overspecs	PC	clear	uvex supravision CR
Oil and gas	Spectacles Overspecs Goggles	PC	clear	uvex supravision plus
Plant visitors	Spectacles Overspecs	PC	clear	uvex supravision excellence uvex supravision sapphire uncoated

Safety Eyewear

Overview

Model	Name	Product	Order quantity multiples/ Order unit	uvex supravision sapphire	uvex supravision plus	uvex supravision excellence	uvex supravision extreme	uvex supravision ETC	uvex supravision clean	uvex supravision AR	Silver mirror, inside anti-fog	uvex supravision variomatic	uvex infradur	uvex infradur plus	CA uncoated	CA anti-fog on the inside	Scratch-resistant on both sides	Scratch-resistant + anti-fog	Uncoated	Page
9128	uvex pheos nxt	Plastic safety spectacles	10 PC			■														29
9134	uvex meteor	Plastic safety spectacles	5 PC	■															■	54
9137	uvex ceramic	Metal safety spectacles	5 PC														■			54
9143	uvex i-lite	Plastic safety spectacles	10 PC			■														31
9143	uvex i-guard	Plastic safety spectacles	8 PC			■														31
9143	uvex i-guard+	Safety goggles	8 PC			■														31
9143	uvex i-range	Replacement lenses	15 PC			■														31
9143	uvex i-range	Headband	8 PC																	31
9145	uvex pure-fit	Plastic safety spectacles	75 PC			■													■	33
9155	uvex mercury	Metal safety spectacles	5 PC	■																54
9159	uvex winner	Metal safety spectacles	5 PC														■	■		55
9160	uvex i-vo	Plastic safety spectacles	10 PC	■		■														52
9161	uvex 9161	Plastic safety spectacles	5 PC	■	■														■	55
9164	uvex astrospec 2.0/astrospec 2.0 CB	Plastic safety spectacles	10 PC	■	■	■	■													49
9169	uvex super OTG	Plastic safety spectacles	8 PC	■		■														56
9169	uvex super f OTG	Plastic safety spectacles	8 PC	■		■														57
9169	uvex super f OTG CR	Plastic safety spectacles	8 PC						■											57
9169	uvex super f OTG	Plastic safety spectacles	PC									■								57
9169	uvex super f OTG	Plastic safety spectacles UV525	8 PC	■																57
9169	uvex super f OTG	Infrared protection spectacles	8 PC											■						67
9169	uvex super f OTG	Safety spectacles - welding protection	8 PC				■							■						69
9169	uvex super OTG/super f OTG	Replacement lenses	10 PC			■														56/57
9172	uvex super g	Plastic safety spectacles	10 PC	■	■	■														50
9172	uvex super g	Replacement lenses	20 PC			■														50
9178	uvex super fit	Plastic safety spectacles	10 PC	■	■	■		■												51
9178	uvex super fit	Replacement lenses	20 PC			■														51
9181	uvex suXxeed	Plastic safety spectacles	10 PC			■														35
9181	uvex suXxeed	Replacement lenses	20 PC			■														35
9181	uvex suXxeed	Clip-in frame	20 PC																	35
9183	uvex i-5	Plastic safety spectacles	10 PC	■		■		■												37
9183	uvex i-5	Clip-in frame	20 PC																	37
9183	uvex i-5	Safety spectacles - welding protection	10 PC											■						37
9190	uvex i-3/uvex i-3s	Plastic safety spectacles	10 PC	■	■	■				■	■									44/45
9190	uvex i-3	Plastic safety spectacles	PC							■		■								44
9190	uvex i-3/uvex i-3s	Replacement lenses	20 PC			■														44/45
9190	uvex i-3/uvex i-3s	Clip-in frame	20 PC																	44/45
9192	uvex pheos/uvex pheos CB/uvex pheos s	Plastic safety spectacles	10 PC		■	■	■	■			■									42/43
9192	uvex pheos guard/uvex pheos s guard	uvex pheos headband version	10 PC				■													43
9192	uvex pheos/uvex pheos s	Clip-in frame	20 PC																	43
9193	uvex sportstyle	Plastic safety spectacles	10 PC		■	■	■	■		■	■									40
9193	uvex sportstyle	Plastic safety spectacles	PC									■								40
9193	uvex sportstyle	Replacement lenses	20 PC				■													40

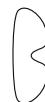

Model	Name	Product	Order quantity multiples/ Order unit	uvex supravision sapphire	uvex supravision plus	uvex supravision excellence	uvex supravision extreme	uvex supravision ETC	uvex supravision clean	uvex supravision AR	Silver mirror, inside anti-fog	uvex supravision variomatic	uvex infradur	uvex infradur plus	CA uncoated	CA anti-fog on the inside	Scratch-resistant on both sides	Scratch-resistant + anti-fog	Uncoated	Page
9194	uvex i-works	Plastic safety spectacles	10 PC			■					■									47
9194	uvex i-works	Replacement lenses	20 PC			■														47
9198	uvex pheos cx2	Plastic safety spectacles	10 PC	■		■	■	■			■									41
9198	uvex pheos cx2	Infrared protection spectacles	10 PC											■						67
9199	uvex x-fit	Plastic safety spectacles	10 PC	■		■		■												39
9199	uvex x-fit pro	Plastic safety spectacles	10 PC			■														38
9199	uvex x-fit pro (ohne Slider)	Plastic safety spectacles	10 PC			■														38
9199	uvex x-fit/uvex x-fit pro	Clip-in frame	20 PC																	39
9231	uvex polavision	Plastic safety spectacles	PC															■		54
9301	uvex ultravision	Safety goggles	4 PC		■	■										■				62/63
9301	uvex ultravision	Replacement lenses	30/50 PC			■										■				62/63
9300	uvex ultravision	Tear-off films	10 PC																	62/63
9301	uvex ultravision faceguard	Safety goggles	18 PC			■														64
9301	uvex ultravision	Goggles with helmet attachment	4 PC													■				64
9301	uvex ultravision	Mouth shield	PC																■	64
9302	uvex ultrasonic	Safety goggles	4 PC			■	■													61
9302	uvex ultrasonic CR	Safety goggles	4 PC						■											60/61
9302	uvex ultrasonic	Replacement lenses	15 PC			■	■		■											61
9302	uvex ultrasonic flip-up	Safety goggles - welding protection	4 PC			■							■							70
9302	uvex ultrasonic flip-up	Replacement lenses	15 PC										■							70
9305	uvex 9305	Safety goggles	4 PC													■				65
9309	uvex pheos cx2 sonic	Safety goggles	10 PC					■												59
9320	uvex megasonic	Safety goggles	4 PC			■	■	■												58
9320	uvex megasonic CR	Safety goggles	4 PC						■											60
9320	uvex megasonic	Replacement lenses	15 PC			■		■	■											58/70
9320	uvex megasonic	Headband	4 PC																	58
9320	uvex megasonic	Safety goggles - welding protection	4 PC											■						70
9405	uvex 9405	Safety goggles	4 PC													■				65
6109		RX insert astrospec 2.0	PC																	49
9972		Microfibre cloth	10 PC																	71
9954		Eyewear case	10 PC																	72
9954		Microfibre bag	10 PC																	72
9957		Display	PC																	71
9957		SECU-Box	PC																	72
9958	uvex pheos/uvex pheos s	Headband	10 PC																	73
9958	uvex x-fit/x-fit pro	Headband	10 PC																	73
9959		Neck hang cord	10 PC																	73
9963		Cleaning towelettes	PC																	71
9970		Cleaning station	PC																	71
9971		Replacement cleaning papers	PC																	71
9972		Cleaning fluid	PC																	71
9973		Plastic pump	PC																	71

Innovative laser protection products

At laservision, an integral part of uvex, we protect one of the most sensitive organs from laser beams: the eye.

For more than 35 years, we have been committed worldwide to protecting eyes with customer-oriented, innovative products. Whether in industry, research and development or in the medical sector – laservision laser protection products stand for standards-compliant quality and safety.

We offer a diverse portfolio: Our eyewear, windows, curtains/blinds and screens provide optimal protection because our products are in line with the uvex safety group's DNA and motto: **protecting people.**



Laser protection for optical tables

Large area laser protection such as: curtains, blinds, screens, roll-ups

Active laser protection windows

Laser protection eyewear made of plastic, glass or with reflective coating, laser protection visors

Patient protection, magnifying glasses, IPL glasses

Laser protection windows made of glass and plastic

laservision

laservision

LASERVISION GmbH & Co. KG
 T: +49 911 9736-8100
 E: info@lvg.com
 I: uvex-laservision.de

uvexlaservision

uvex-laservision

laservision gmbh

uvexlaservision

laservision_de



You can find more information at uvex-laservision.de/en/



Hearing Protection

Product system planet series › Hearing Protection

uvex has developed the **protecting planet** icon, to help raise awareness of its commitment to achieving increased sustainability. Based on the brand claim, **protecting people**, our sustainable approach integrates three core interlinked pillars – **ecology, economy** and **social responsibility**, that are incorporated throughout the business to improve our sustainability performance.

This explains the comprehensive audit, measurement and evaluation management process uvex undertakes along the entire value chain to ensure its products are as sustainable as possible.

uvex xact-fit planet

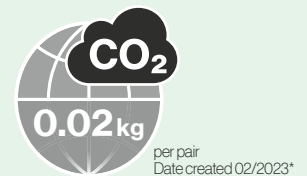

MADE IN SWEDEN 

 **protecting planet**
by using recycled material //
by maximum reduction of pollutants

Ergonomically shaped stems

› 100 percent recycled polypropylene (PP)

Oval-shaped foam earplugs

› production is subject to strict controls
› contain as few harmful substances as possible



Packaging

100%

made from recycled cardboard

Electricity required in production

100%

comes from renewable energy sources



Ergonomic stems

100%

recycled polypropylene



protecting planet

by using environmentally-friendly packaging

Packaging

› made from 100 percent recycled cardboard



protecting planet

by reducing CO₂ emissions

Production at SwedSafe, Sweden

- › SwedSafe is part of the uvex group
- › leaves only a small carbon footprint
- › no consumption of fossil fuels
- › electricity comes from 100 percent renewable energy sources
- › certified in accordance with Environmental Management ISO 14001
- › promoting biodiversity at the site: creation of insect habitats by planting natural grass landscapes and sowing additional flowering plants

Hearing Protection

All ears when it comes to safety

Noise-induced hearing loss is still one of the most common occupational hazards of all.

It develops painlessly, is progressive and generally goes unnoticed. It is the fact that it's irreversible which makes it so serious. The risk to hearing and the importance of hearing protection are often recognised too late.

What is noise?

Loud sounds which comprise noise not only pose a risk to hearing but can also be distracting and debilitating.

Persistent low-grade sounds such as a clock ticking or a dripping tap can also affect concentration levels.

Adverse health effects caused by harmful noise levels

Listed below are the maximum periods of time a person should be exposed to harmful noise per day without wearing hearing protection.

85 dB	8 hours	103 dB	7.5 minutes
88 dB	4 hours	106 dB	4 minutes
91 dB	2 hours	109 dB	2 minutes
94 dB	1 hour	112 dB	1 minute
97 dB	30 minutes	115 dB	30 seconds
100 dB	15 minutes		



Only those who suffer from hearing loss really understand just how essential a good sense of hearing is and that protecting it should be a top priority.

What are the consequences of noise?

We use our hearing continuously, it never gets a break and cannot be "switched off". We are exposed to noise every day, all day, from multiple sources so our hearing is under constant stress.

These daily demands on our ears can lead to irreversible noise-induced hearing loss. But, it's not just our hearing that is affected; noise means stress for the entire body. Noise affects us subconsciously and can lead to difficulty concentrating, gastrointestinal illness, elevated blood pressure and increased risk of a heart attack.





Tests and standards

All uvex hearing protection products comply with the requirements of current EU legislation, including the PPE regulation (EU) 2016/425, which ensures CE conformity. The products have been tested in accordance with the applicable European standards and additional international standards. As category III products, they are subject to Module D inspections by a notified body, as indicated by the code printed on the product after the CE mark.

Continuous quality assurance with ISO 9001/2015, I ISO 14001:2015 ISO 45001.

Applicable DIN EN norms are:

- EN 352: Part 1 Earmuffs
- EN 352: Part 2 Ear plugs
- EN 352: Part 3 Earmuffs attached to a safety helmet
- EN 352: Part 4 Level-dependent hearing protection earmuffs
- EN 352: Part 6 Earmuffs with communication equipment
- EN 352: Part 8 Audio earmuffs for entertainment

Abbreviations for protection values with explanations

SNR	Single Number Rating/average protection capacity
f/Hz	Frequency given as a unit of Hertz
(MA) Mean Attenuation	Mean attenuation
(SD)	Standard Deviation
(APV) Assumed Protection Value	Assumed protection value
HML value	H: Attenuation value at high frequencies
	M: Attenuation value at medium frequencies
	L: Attenuation value at low frequencies

Hearing protection

Size and fit

Everyone's ear canal is unique – much like a fingerprint. Which is why it's all the more important that you choose adequate and suitable hearing protection that is the correct size to achieve a good fit. uvex offers a complete range of hearing protection to ensure all wearers are able to achieve a fit that's right for them.

Choosing the wrong size can severely reduce the protection value, exposing wearers to harmful noise, and makes the ear plugs uncomfortable to wear.

Only way to find out is to measure your personal attenuation (PAR) with a fit test system, we introduce uvex xact-fit test.

This will secure you choose the right protection based on your need.

It is best to try different sizes to find the one that gives you the best protection and fit. With the uvex com4-fit and uvex x-fit, we offer something for the majority of ear canal shapes.

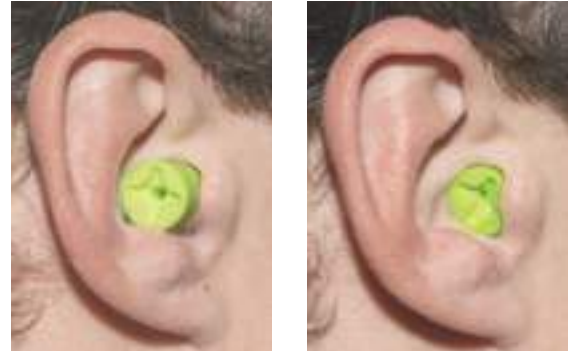

Just wearing earplugs is not a guarantee for proper hearing protection. Without measure we don't know. **xact-fit test measure the Personal Attenuation Rating for any user, with unmodified earplugs.**

uvex xact-fit test

Hearing Protection Fit-Testing System

uvex xact-fit delivers one of the most robust and efficient fit-testing systems on the market – helping you understand exactly how much protection you're receiving from your Hearing Protection Device, regardless of brand or model. This innovative portable kit comes with Bluetooth headphones and tablet for a cordless, quick set-up that can be used anywhere, complete with a carrying case.



Pre-installed software and cloud storage on the tablet allow for automatic upload of information and results, easy access to files on multiple devices, and increased security. Fit-testing workers for proper hearing protection has never been so easy.



How uvex xact-fit works

The uvex xact-fit System was created with the user's experience in mind – as the most portable and easy-to-use system on the market.

Using the Real Ear Attenuation at Threshold (REAT), users undergo a series of tests where they must determine their Hearing Threshold score, both with and without hearing protection.

This is the lowest volume at which a sound can be detected, and it is different for every person.

The difference between the two scores determines their Personal Attenuation Rating (PAR), which represents the amount of protection they are receiving based on how they fit their earplug.

Hearing Protection

Different situations, different ears



Look out for the different sizes

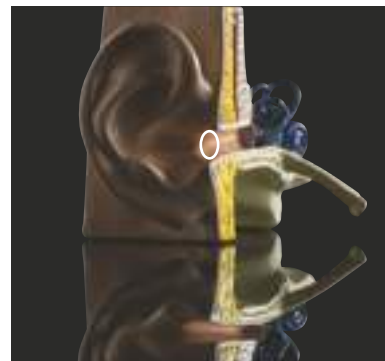

The cross-section of an ear canal is oval shaped

Anyone can get used to wearing hearing protection; you just need to choose the right type of protection for you.

- wearing time
- noise levels
- choose earplugs according to the size of your ear canal
- earmuffs are not recommended for hot workplaces
- fitting accuracy (glasses wearers)

- for earmuff wearers, the weight should be taken into consideration
- handling (dirty hands, gloves, disabilities)
- compatibility with other PPE (helmet, glasses, respiratory protection)

The right hearing protection can make even the loudest noises more comfortable.

Hearing protection for every situation

There are many types of uvex hearing protection which are suitable for different situations and if you work in or are passing through high noise level areas you need the right level of protection.

It is important to strike the right balance between the need to adequately protect your hearing from dangerous noise while not compromising your ability to hear and communicate.

The below chart gives you an overview of which uvex hearing protection may be suitable based on the noise level.

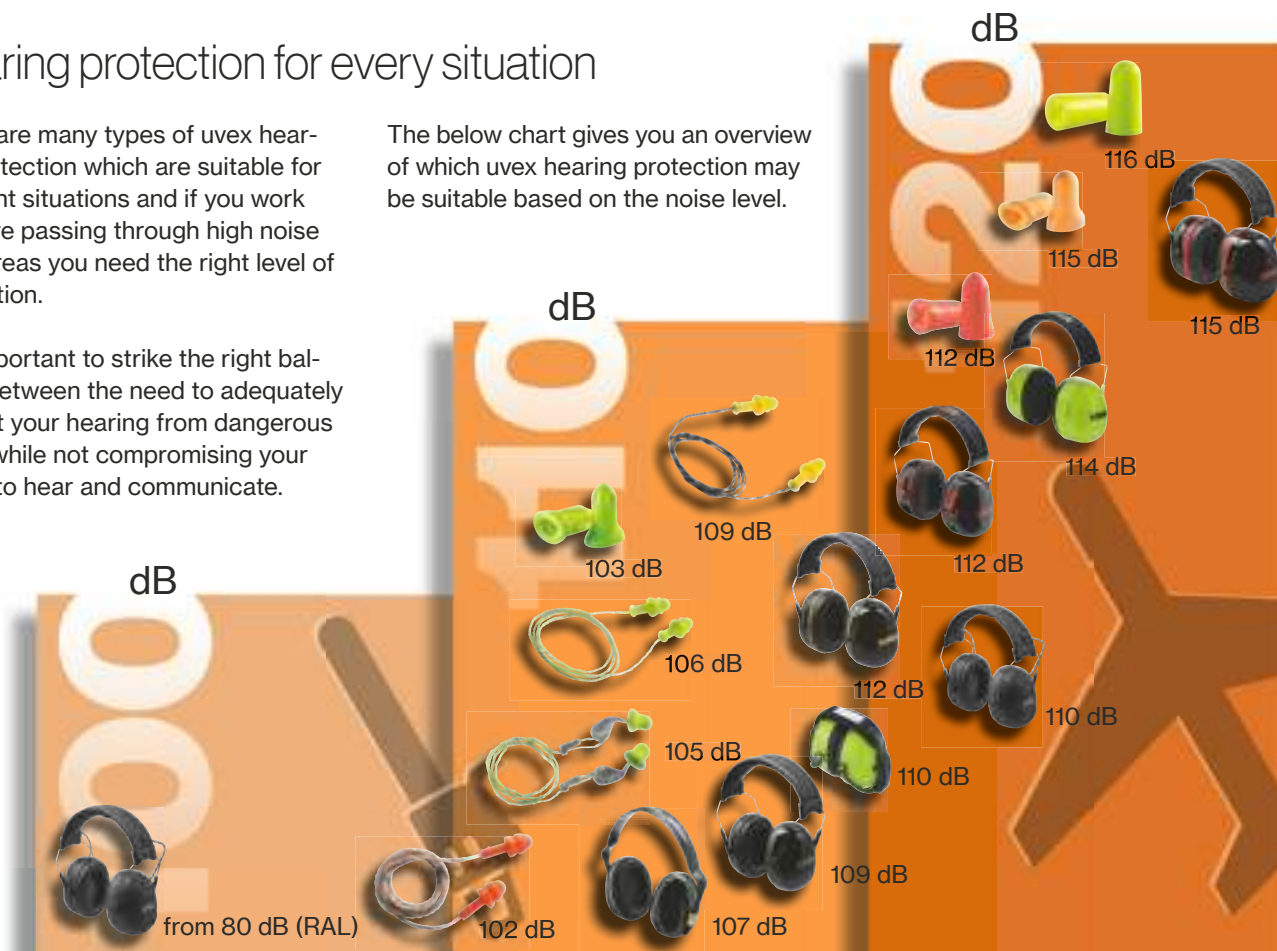

Hearing protection

The uvex xact-fit family

Using earplugs has never been easier



Easy, fast and accurate insertion

Medium protection capacity for excellent speech and signal recognition for easy communication

Replacement earplugs are available, for a cost-effective and environmentally conscious choice

No rolling required, so they can be used with dirty hands or while wearing gloves

Ergonomically shaped stems make fitting easy, hygienic, accurate and achieves a high level of wearer comfort

Thumb indentations with left and right marking ensures correct insertion and easy fitting

The shape means it fits most ear canals securely and comfortably

The uvex xact-fit family



uvex xact-fit

Catalogue page 92



uvex xact-fit detec

Catalogue page 94



uvex xact-fit multi reusable

Catalogue page 92



uvex xact-band

Catalogue page 96

Hearing protection

The uvex xact-fit family



uvex xact-fit – intelligent ergonomics

A new dimension of wearer comfort

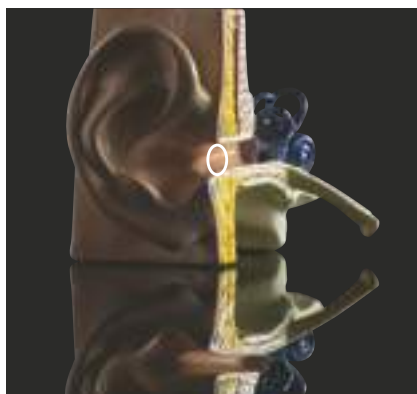

The cross-section of an ear canal is oval shaped

The stem is ergonomically shaped to fit either the left or right ear to increase wearer comfort and make the earplugs easier to insert and remove.

The design is easily identifiable from a distance, making it easier to monitor usage in accordance with your company's regulations.

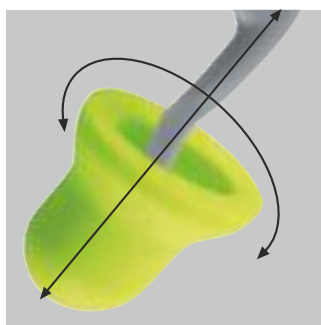

Perfect fit

Oval-shaped foam earplugs mimic the natural shape of the ear canal for low pressure fit and enhanced comfort

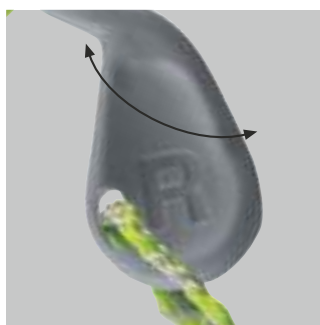

Ergonomic thumb indentations

The ergonomic thumb indentations with left and right marking ensures correct insertion and easy fitting

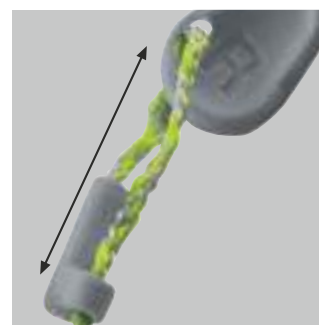

Adjustable cord

Hearing Protection

Disposable ear plugs

uvex hi-com

A unique design – even on the inside

Patented

Designed to minimise pressure in the ear canal

Reduced risk of over protection and feelings of isolation

Intricate recess design for long-term wearer comfort

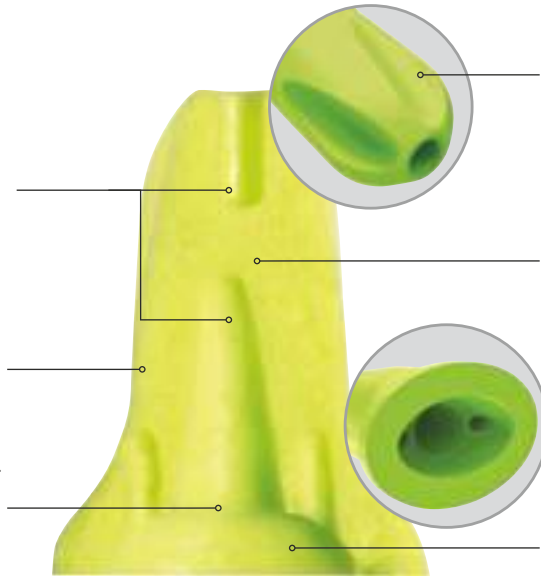

Large surface area delivers softer acoustics and absorbs inner ear sounds which can become obvious when wearing hearing protection in quieter areas

Defined protection zone for controlled noise reduction, resulting in excellent speech and signal recognition and good communication

Grip recess for easy removal



2112100
2112095



2112106



2112095
Table-top dispenser box



2112101

uvex hi-com

- delivers low, flat attenuation allowing for excellent speech and sound recognition
- large surface area delivers softer acoustics and absorbs inner ear sounds which can become obvious when wearing hearing protection in quieter areas
- available in two colours

uvex hi-com		
Art. no.	2112100	2112101
Design	without cord	with cord
Standard	EN 352-2:2020	EN 352-2:2020
Colour	lime	lime
Order unit	CT	CT
Content	200 PR, packed in pairs in CT	100 PR, packed in pairs in CT

uvex hi-com		
Art. no.	2112095	2112106
Design	without cord	without cord
Standard	EN 352-2:2020	EN 352-2:2020
Colour	lime	beige
Order unit	CT	CT
Content	100 PR, packed in pairs in CT	200 PR, packed in pairs in CT

f/Hz	125	250	500	1000	2000	4000	8000	SNR	26 dB H	30 dB M	33 dB L	18 dB
MA dB	17,6	19,0	25,4	29,6	34,5	39,0	43,8	SNRm	30,1 dB Hm	34,4 dB Mm	27,3 dB Lm	21,9 dB
SD dB	4,2	3,7	5,0	5,2	3,8	5,5	4,1	SNRs	3,7 dB Hs	3,9 dB Ms	3,9 dB Ls	3,7 dB
APV dB	13,5	15,3	20,3	24,5	30,6	33,5	39,6					

Refill boxes for uvex "one2click" dispenser on page 90

MADE IN SWEDEN

Hearing Protection

Disposable ear plugs



2112012



2112004
2112096
2112131

uvex com4-fit

- disposable earplugs with a compact, ergonomic design
- perfect for narrow and smaller ear canals
- suitable for use in high noise environments
- patented x-grip technology reduces pressure on the ear canal and aids easy, hygienic removal
- increased wearing comfort, when worn for extended periods

uvex com4-fit				
Art. no.	2112004	2112096	2112131	2112012
Design	without cord	without cord	without cord	with cord
Standard	EN 352-2:2020	EN 352-2:2020	EN 352-2:2020	EN 352-2:2020
Colour	light orange	light orange	light orange	light orange
Order unit	CT	CT	CT	CT
Content	200 PR, packed in pairs in CT	100 PR, packed in pairs in CT	15 PR, loose in CT	100 PR, packed in pairs in CT

f/Hz	63	125	250	500	1000	2000	4000	8000	SNR	33 dB H	34 dB M	31 dB L	29 dB
MA dB	28.9	31.0	33.6	33.8	33.6	36.2	40.6	44.3	SNRm	36.3 dB Hm	36.6 dB Mm	33.9 dB Lm	33.1 dB
SD dB	3.4	5.2	5.4	5.4	4.0	4.2	3.7	2.9	SNRs	2.9 dB Hs	2.8 dB Ms	3.3 dB Ls	4.2 dB
APV dB	25.5	25.8	28.2	28.4	29.6	32.0	36.9	41.4					



2112010



2112001
2112094
2112133
2112087

uvex x-fit

- tapered plug shape ensures natural, pressure free fit – maximising comfort and protection levels
- suitable for use in high noise environments
- patented x-grip technology reduces pressure on the ear canal and aids easy, hygienic removal

uvex x-fit						
Art. no.	2112001	2112094	2112013	2112133	2112010	2112087
Design	without cord	without cord	without cord	without cord	with cord	without cord
Standard	EN 352-2:2020	EN 352-2:2020	EN 352-2:2020	EN 352-2:2020	EN 352-2:2020	EN 352-2:2020
Colour	lime	lime	lime	lime	lime	lime
Order unit	CT	CT	CT	CT	CT	CT
Content	200 PR, packed in pairs in CT	100 PR, packed in pairs in CT	50 PR, loose in CT	15 PR, loose in CT	100 PR, packed in pairs in CT	100 PR, packed in pairs in CT

f/Hz	63	125	250	500	1000	2000	4000	8000	SNR	37 dB H	36 dB M	35 dB L	34 dB
MA dB	35.3	38.4	39.3	40.8	38.9	37.8	45.9	45.1	SNRm	40.0 dB Hm	39.1 dB Mm	38.1 dB Lm	38.0 dB
SD dB	4.2	6.3	5.3	5.5	5.5	4.3	3.9	4.6	SNRs	2.8 dB Hs	3.1 dB Ms	3.2 dB Ls	3.6 dB
APV dB	31.1	32.1	34.0	35.3	33.4	33.5	42.0	40.5					



2112060
2112093

uvex xtra-fit

- disposable earplugs ideal for larger ear canals
- adapts to the shape and size of the ear canal, thereby optimising fit and protection
- very soft and comfortable to wear

uvex xtra-fit	
Art. no.	2112060 2112093
Design	without cord
Standard	EN 352-2:2020
Colour	orange
Order unit	BG CT
Content	200 PR, packed in pairs in BG 100 PR, packed in pairs in CT

f/Hz	63	125	250	500	1000	2000	4000	8000	SNR	35 dB H	34 dB M	33 dB L	32 dB
MA dB	32.7	34.8	36.8	38.9	36.9	36.2	44.0	41.5	SNRm	38.1 dB Hm	37.1 dB Mm	36.5 dB Lm	36.4 dB
SD dB	4.6	4.4	5.6	5.2	4.7	3.7	4.0	5.0	SNRs	2.9 dB Hs	2.7 dB Ms	3.2 dB Ls	3.9 dB
APV dB	28.1	30.4	31.2	33.7	32.2	32.5	40.0	36.5					

Hearing Protection

Disposable ear plugs · Earplug dispenser · Refill packs



2111990

2111991

2111992

uvex dispenser “one2click”

- easy-to-use and robust hearing protection dispenser with two different mounting options
- earplugs available to hand with just one click
- ensures hygienic dispensing whenever it's needed
- magnetic wall mount requires no drilling
- can be refilled even if the container is not empty
- collecting tray prevents earplugs from falling on the floor
- suitable for all uvex disposable earplugs
- quantities: 600 pairs (extra-fit 500 pairs)
- magnetic variant for flexible use on all magnetic surfaces (2112988)
- stationary wall mounting using screws (2112000)
- magnetic wall mount can be retrofitted individually (2112989)

uvex dispenser "one2click"		
Art. no.	2112000	2111988
Mounting	empty, screw mounting	empty, magnetic mounting
Order unit	CT	CT

uvex magnetic bracket for dispenser	
Art. no.	2111989
Mounting	retrofit kit for dispenser for magnetic mounting
Material	polished steel
Order unit	CT

uvex dispenser "one2click"			
Art. no.	2111990	2111991	2111992
Type	ready to use (filled), screw mounting	ready to use (filled), screw mounting	ready to use (filled), screw mounting
	600 pairs of x-fit	600 pairs of com4-fit	600 pairs of hi-com
Order unit	CT	CT	CT

► For the ready-to-use magnetic version, the magnetic plate (2112989) must be ordered separately

uvex dispenser “one2click” – Refill packs

	uvex x-fit	uvex com4-fit	uvex xact-fit
Art. no.	2112022	2112023	2124003
Design	without cord	without cord	replacement earplugs
Standard	EN 352-2:2020	EN 352-2:2020	EN 352-2:2020
	additional requirement: S, V, W, E,	additional requirement: S, V, W, E,	additional requirement: W
SNR	37 dB (see page 89)	33 dB (see page 89)	26 dB (see page 92)
Colour	lime	light orange	lime
Size	M	S	M
Order unit	CT	CT	CT
Content	300 PR, loose in CT	300 PR, loose in CT	400 PR, loose in CT

	uvex hi-com	uvex hi-com	uvex xtra-fit
Art. no.	2112118	2112119	2112061
Design	without cord	without cord	without cord
Standard	EN 352-2:2020	EN 352-2:2020	EN 352-2:2020
	additional requirement: W	additional requirement: W	additional requirement: S, V, W, E,
SNR	26 dB (see page 88)	26 dB (see page 88)	35 dB (see page 89)
Colour	lime	beige	orange
Size	M	M	L
Order unit	CT	CT	BG
Content	300 PR, loose in CT	300 PR, loose in CT	250 PR, loose in BG



Hearing protection

uvex xact-fit test



2124099



uvex xact-fit test

- Bluetooth-capable headphones allows for mobile, cordless testing
- earmuff design allows all kinds of earplugs to fit underneath and be tested
- cloud storage use for easy access to files on multiple devices
- automatic upload of information and test results
- open system gives the ability to test any brand of earplug
- provides full report of the test to help user choose earplug
- portable, cordless tablet for ease of use
- pre-installed software with quick set-up process
- fast and easy set-up compared to competitive systems



2124097



2124098

uvex xact-fit test	
Art. no.	2124099
Type	uvex xact-fit test system
Order unit	PC

uvex xact-fit test travel suitcase for xact-fit test earmuff	
Art. no.	2124097
Type	accessories for uvex xact-fit test
Colour	black
Order unit	PC

uvex hygiene kit, spare sealing cushions	
Art. no.	2124098
Type	accessories for uvex xact-fit test earmuffs
Colour	black
Order unit	PC

Hearing Protection

Disposable earplugs · Reusable earplugs · uvex xact-fit



2124001



2124002



2124026

minibox

uvex xact-fit planet

- ergonomically shaped pins made from 100% recycled material
- left/right pod carriers simplify fitting and ensure accurate fit everytime
- tapered plug shape ensures natural, pressure free fit – maximizing comfort and protections level
- adjustable neck cord can be altered to wearers for increased safety
- all packaging is made of recycled cardboard

uvex xact-fit planet		uvex xact-fit planet replacement earplugs	
Art. no.	2124001	2124026	2124002
Design	with reusable pin, in minibox	with reusable pin in earplug box	replacement earplugs, in minibox
Standard	EN 352-2:2020	EN 352-2:2020	EN 352-2:2020
Colour	lime	lime	lime
Order unit	CT	CT	CT
Content	50 PR, packed in pairs in CT	50 PR, packed in pairs in CT	250 PR, CT of 5 pairs

f/Hz	63	125	250	500	1000	2000	4000	8000	SNR	26 dB H	28 dB M	23 dB L	20 dB
MA dB	16.6	19.4	22.0	25.6	27.5	31.8	34.4	36.9	SNRm	29.7 dB Hm	31.3 dB Mm	27.2 dB Lm	23.9 dB
SD dB	5.4	4.9	4.2	4.9	4.7	3.8	4.4	6.0	SNRs	3.6 dB Hs	3.2 dB Ms	3.9 dB Ls	4.0 dB
APV dB	11.2	14.5	17.8	20.7	22.8	28.0	30.0	30.9					



2124019



2124017

uvex xact-fit multi reusable

- reusable earplugs with thumb indentations
- oval-shaped earplugs mimics the natural shape of the ear canal for optimum fit and comfort
- interchangeable replacement earplugs
- can be handled with dirty hands or while wearing gloves
- available in two sizes

uvex xact-fit multi reusable S		2124017	
Art. no.	2124019	2124017	
Design	with oval-shaped reusable earplugs, in minibox	with oval-shaped reusable earplugs, in earplug box	
Standard	EN 352-2:2020	EN 352-2:2020	
Colour	grey, transparent	grey, transparent	
Size	S	S	
Order unit	CT	CT	
Content	50 PR, packed in pairs in CT	50 PR, packed in pairs in CT	



2124020



2124018

uvex xact-fit multi reusable M/L		2124018	
Art. no.	2124020	2124018	
Design	with oval-shaped reusable earplugs, in minibox	with oval-shaped reusable earplugs, in earplug box	
Standard	EN 352-2:2020	EN 352-2:2020	
Colour	grey, transparent	grey, transparent	
Size	M/L	M/L	
Order unit	CT	CT	
Content	50 PR, packed in pairs in CT	50 PR, packed in pairs in CT	

f/Hz	125	250	500	1000	2000	4000	8000	SNR	26 dB H	26 dB M	24 dB L	22 dB
MA dB	26.9	25.4	26.1	28.3	31.9	32.8	37.2	SNRm	29.6 dB Hm	30.6 dB Mm	27.5 dB Lm	26.3 dB
SD dB	4.4	4.5	5.4	5.5	4	6.9	6.7	SNRs	3.7 dB Hs	4.4 dB Ms	3.8 dB Ls	3.9 dB
APV dB	22.5	20.9	20.7	22.8	27.9	25.9	30.5					

Hearing Protection

Reusable ear plugs



minibox
2111201



2111237

uvex whisper

- easy-to-clean reusable corded earplugs
- smooth, dirt-repellent surface can be easily cleaned using soap and water
- earplug box for hygienic storage when not in use
- with the cord, the earplugs are conveniently to hand – in low-noise areas, the earplugs can be worn comfortably around the neck

uvex whisper	
Art. no.	2111201 2111237
Design	with cord, in minibox with cord, in earplug box
Standard	EN 352-2:2020 EN 352-2:2020
Colour	orange orange
Order unit	CT CT
Content	50 PR, in pairs in CT 50 PR, in pairs in CT

f/Hz	63	125	250	500	1000	2000	4000	8000	SNR	22 dB H	23 dB M	19 dB L	17 dB
MA dB	23.7	23.2	21.1	22.6	24.8	31.7	33.4	39.4	SNRm	27.1 dB Hm	29.6 dB Mm	24.3 dB Lm	22.4 dB
SD dB	5.6	5.8	6.8	5.2	5.7	6.0	9.5	8.2	SNRs	5.6 dB Hs	6.3 dB Ms	5.2 dB Ls	5.7 dB
APV dB	18.1	17.4	14.3	17.4	19.1	25.7	23.9	31.2					

uvex whisper +

- easy-to-clean reusable corded earplugs
- smooth, dirt-repellent surface can be easily cleaned using soap and water
- earplug box for hygienic storage when not in use
- with the cord, the earplugs are conveniently to hand – in low-noise areas, the earplugs can be worn comfortably around the neck



minibox
2111212



2111238

uvex whisper +	
Art. no.	2111212 2111238
Design	with cord, in minibox with cord, in earplug box
Standard	EN 352-2:2020 EN 352-2:2020
Colour	lime lime
Order unit	CT CT
Content	50 PR, in pairs in CT 50 PR, in pairs in CT

f/Hz	63	125	250	500	1000	2000	4000	8000	SNR	27 dB H	27 dB M	24 dB L	22 dB
MA dB	26.6	26.9	24.3	26.1	28.8	32.8	32.6	38.1	SNRm	30.3 dB Hm	31.4 dB Mm	28.0 dB Lm	26.0 dB
SD dB	6.1	6.1	4.1	5.1	5.1	5.0	6.5	5.3	SNRs	3.8 dB Hs	4.0 dB Ms	4.1 dB Ls	4.0 dB
APV dB	20.5	20.8	20.2	21.0	23.7	27.8	26.1	32.8					

uvex whisper supreme

- easy-to-clean reusable corded earplugs
- smooth, dirt-repellent surface can be easily cleaned using soap and water
- earplug box for hygienic storage when not in use
- with the cord, the earplugs are conveniently to hand – in low-noise areas, the earplugs can be worn comfortably around the neck



2111235

uvex whisper supreme	
Art. no.	2111235
Design	with cord, in earplug box
Standard	EN 352-2:2020
Colour	yellow
Order unit	CT
Content	50 PR, in pairs in CT

f/Hz	125	250	500	1000	2000	4000	8000	SNR	30 dB H	31 dB M	27 dB L	27 dB
MA dB	33.8	29.2	32.7	30.0	36.0	34.3	41.0	SNRm	33.4 dB Hm	33.9 dB Mm	31.0 dB Lm	30.4 dB
SD dB	5.1	4.6	4.9	5.0	4.0	3.6	4.4	SNRs	2.9 dB Hs	2.7 dB Ms	3.6 dB Ls	3.6 dB
APV dB	28.7	24.5	27.8	25.0	32.0	30.6	36.6					

Hearing Protection

Detectable ear plugs



211214

uvex hi-com detec

- metal powder in cord allows full detection even if the cord is shredded, coloured blue for easy recognition
- oval pods match the shape of the outer ear ensuring pressure free, comfortable fit
- delivers low, flat attenuation allowing for excellent speech and sound recognition
- large surface area delivers softer acoustics and absorbs inner ear sounds which can become obvious when wearing hearing protection in quieter areas

uvex hi-com detec												
Art. no.	211214											
Design	with cord, detectable											
Standard	EN 352-2:2020											
Colour	blue											
Order unit	CT											
Content	100 PR, in pairs in CT											

f/Hz	125	250	500	1000	2000	4000	8000	SNR	26 dB H	30 dB M	23 dB L	18 dB
MA dB	17.6	19.0	25.4	29.6	34.5	39	43.8	SNRm	30.1 dB Hm	34.4 dB Mm	27.3 dB Lm	21.9 dB
SD dB	4.2	3.7	5.0	5.2	3.8	5.5	4.1	SNRs	3.7 dB Hs	3.9 dB Ms	3.9 dB Ls	3.7 dB
APV dB	13.5	15.3	20.3	24.5	30.6	33.5	39.6					



2112011

uvex x-fit detec

- disposable earplugs coloured blue with metal component for easy detection
- suitable for use in high noise environments
- tapered shape matches the ear canal anatomy for comfortable and secure fit
- patented x-grip technology reduces pressure on the ear canal and aids easy, hygienic removal
- sealed PU foam reduces the potential for contamination

uvex x-fit detec												
Art. no.	2112011											
Design	with cord, detectable											
Standard	EN 352-2:2020											
Colour	blue											
Order unit	CT											
Content	100 PR, in pairs in CT											

f/Hz	63	125	250	500	1000	2000	4000	8000	SNR	37 dB H	36 dB M	35 dB L	34 dB
MA dB	35.3	38.4	39.3	40.8	38.9	37.8	45.9	45.1	SNRm	40.0 dB Hm	39.1 dB Mm	38.1 dB Lm	38.0 dB
SD dB	4.2	6.3	5.3	5.5	5.5	4.3	3.9	4.6	SNRs	2.8 dB Hs	3.1 dB Ms	3.2 dB Ls	3.6 dB
APV dB	31.1	32.1	34.0	35.3	33.4	33.5	42.0	40.5					



2124011

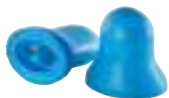

2124013



minibox

uvex xact-fit detec

- disposable plugs with integrated metal elements makes both earplugs and cord detectable
- tapered plug shape ensures natural, pressure free fit – maximising comfort and protection levels
- left / right pod carriers simplify fitting and ensure accurate fit every-time
- adjustable neck cord can be altered to wearers requirements
- sealed PU foam reduces the potential for contamination for increased hygiene
- replacement pods prolong the life of the product

uvex xact-fit detec												
Art. no.	2124011						2124013					
Design	with reusable pin, detectable						replacement earplugs					
Standard	EN 352-2:2020						EN 352-2:2020					
Colour	blue						blue					
Order unit	CT						CT					
Content	50 PR, in pairs in CT						400 PR, loose in CT					

f/Hz	63	125	250	500	1000	2000	4000	8000	SNR	26 dB H	28 dB M	23 dB L	20 dB
MA dB	16.6	19.4	22.0	25.6	27.5	31.8	34.4	36.9	SNRm	29.7 dB Hm	31.3 dB Mm	27.2 dB Lm	23.9 dB
SD dB	5.4	4.9	4.2	4.9	4.7	3.8	4.4	6.0	SNRs	3.6 dB Hs	3.2 dB Ms	3.9 dB Ls	4.0 dB
APV dB	11.2	14.5	17.8	20.7	22.8	28.0	30.0	30.9					

Hearing Protection

Detectable ear plugs



SNR
dB
22



minibox
2111261



2111262

uvex whisper detec

- easy-to-clean reusable corded earplugs
- smooth, dirt-repellent surface can be easily cleaned using mild soap and water
- earplug box for hygienic storage when not in use
- integrated metal parts and the blue colour ensure the earplugs can be detected in a production environment
- thanks to the cord, the earplugs are always conveniently to hand – in low-noise areas, the earplugs can be worn around the neck

uvex whisper detec	
Art. no.	2111261
Design	with cord detectable, in minibox
Standard	EN 352-2:2020
Colour	blue
Order unit	CT
Content	50 PR, in pairs in CT

f/Hz	63	125	250	500	1000	2000	4000	8000	SNR	22 dB H	23 dB M	19 dB L	17 dB
MA dB	23.7	23.2	21.1	22.6	24.8	31.7	33.4	39.4	SNRm	27.1 dB Hm	29.6 dB Mm	24.3 dB Lm	22.4 dB
SD dB	5.6	5.8	6.8	5.2	5.7	6.0	9.5	8.2	SNRs	5.6 dB Hs	6.3 dB Ms	5.2 dB Ls	5.7 dB
APV dB	18.1	17.4	14.3	17.4	19.1	25.7	23.9	31.2					

SNR
dB
27



minibox
2111260



2111239

uvex whisper+ detec

- easy-to-clean reusable corded earplugs
- smooth, dirt-repellent surface can be easily cleaned using mild soap and water
- earplug box for hygienic storage when not in use
- integrated metal parts and the blue colour ensure the earplugs can be detected in a production environment
- thanks to the cord, the earplugs are always conveniently to hand – in low-noise areas, the earplugs can be worn around the neck

uvex whisper+ detec	
Art. no.	2111260
Design	with cord detectable, in minibox
Standard	EN 352-2:2020
Colour	blue
Order unit	CT
Content	50 PR, in pairs in CT

f/Hz	63	125	250	500	1000	2000	4000	8000	SNR	27 dB H	27 dB M	24 dB L	22 dB
MA dB	26.6	26.9	24.3	26.1	28.8	32.8	32.6	38.1	SNRm	30.3 dB Hm	31.4 dB Mm	28.0 dB Lm	26.0 dB
SD dB	6.1	6.1	4.1	5.1	5.1	5.0	6.5	5.3	SNRs	3.8 dB Hs	4.0 dB Ms	4.1 dB Ls	4.0 dB
APV dB	20.5	20.8	20.2	21.0	23.7	27.8	26.1	32.8					

MADE IN SWEDEN

Hearing Protection

Banded hearing protection



2125361

2125351

uvex x-cap

- ergonomically shaped banded ear protector for optimal positioning in front of the chin
- ergonomically shaped earplugs provide a high level of wearer comfort
- replaceable earplugs
- seal forms at the opening of the ear canal meaning there is no pressure in the ear

uvex x-cap			
Art. no.	2125361		2125351
Design	with band		replacement earplugs
Standard	EN 352-2:2020		
Colour	grey, sky blue, lime		sky blue, lime
Order unit	CT		CT
Content	15 PC, individually packed in CT		60 PR, CT of 5 pairs

f/Hz	63	125	250	500	1000	2000	4000	8000	SNR	23 dB H	27 dB M	20 dB L	18 dB
MA dB	23.7	22.0	21.6	19.0	23.8	31.9	39.6	39.6	SNRm	26.7 dB Hm	30.4 dB Mm	23.1 dB Lm	21.4 dB
SD dB	4.0	2.9	4.7	4.3	3.6	4.0	2.7	3.7	SNRs	3.4 dB Hs	3.0 dB Ms	3.5 dB Ls	3.8 dB
APV dB	19.7	19.1	16.9	14.7	20.2	27.9	36.9	35.9					



2125344

uvex x-fold

- ergonomically shaped banded ear protector for optimal positioning in front of the chin which eliminates noise transfer on contact
- ergonomically shaped replacement earplugs for optimal wearer comfort
- foldable banded ear protectors make storage easy

uvex x-fold			
Art. no.	2125344		2125351
Design	with foldable band		replacement earplugs
Standard	EN 352-2:2020		
Colour	grey, sky blue, lime		sky blue, lime
Order unit	CT		CT
Content	5 PC, individually packed in CT		60 PR, CT of 5 pairs

f/Hz	125	250	500	1000	2000	4000	8000	SNR	26 dB H	30 dB M	23 dB L	21 dB
MA dB	27.1	23.0	24.1	26.2	35.1	39.6	40.4	SNRm	30.1 dB Hm	33.1 dB Mm	26.7 dB Lm	24.7 dB
SD dB	5.1	4.2	4.3	4.2	3.1	3.4	4.4	SNRs	3.6 dB Hs	3.0 dB Ms	3.8 dB Ls	3.8 dB
APV dB	22.0	18.8	19.8	22.0	31.9	36.2	36.0					



2125372

2124002
2124003

uvex xact-band

- extremely low weight – just 4 grams
- seal forms inside the ear canal, just like disposable plugs
- integrated sound absorbers reduce noise transmission through the band
- replacement earplugs can be dispensed through the standard uvex wall mounted dispenser unit
- banded ear protector
- thumb indentations on the stems for quick and easy fitting

uvex xact-band				
Art. no.	2125372		2124002	2124003
Design	with band		replacement earplugs	replacement earplugs
Standard	EN 352-2:2020			
Colour	grey, sky-blue, lime		lime	lime
Order unit	CT		CT	CT
Content	5 PC, individually packed in CT		250 PR, CT of 5 pairs	400 PR, loose in CT

f/Hz	63	125	250	500	1000	2000	4000	8000	SNR	26 dB H	29 dB M	22 dB L	21 dB
MA dB	21.5	23.3	24.7	25.3	27.1	33.0	37.3	38.5	SNRm	30.4 dB Hm	32.4 dB Mm	27.4 dB Lm	25.5 dB
SD dB	3.6	3.6	4.7	6.0	5.5	2.7	4.3	4.9	SNRs	4.5 dB Hs	3.6 dB Ms	5.1 dB Ls	4.6 dB
APV dB	17.9	19.7	20.0	19.3	21.5	30.3	33.0	33.6					



Earmuffs

uvex aXess one

safe. active. connected.



RAL – real active listening

Active listening function with the ability to individually adjust the volume of ambient noise. Safe application thanks to integrated sound level limiter. No over-protection or isolation from the working environment.

Bluetooth® 5.2

Good sound quality, fast data transfer and a large range with optimised energy consumption.

Dual connection mode

The hearing protection can be paired with two Bluetooth devices at the same time.

Certified hearing protection

Attenuation value with SNR 31 dB

Audio streaming

Ideal for monotonous work.

Two surround-sound microphones

For reliable transmission of ambient noise.

Voice microphone

Ensures optimal voice quality.

Status messages

The audio assistant provides you information through voice prompts (“Bluetooth connected”), so there’s no need to remove the hearing protection in hazardous areas.

External audio input

Connects wireless devices or media players via a cable.

Charging socket USB Type-C

Fast charging time thanks to higher performance. Easy handling thanks to rotationally symmetrical connectors.

IP 54 Protection class

Suitable for outdoor use or dusty and damp working areas thanks to sealing caps.

Hands-free telephony

Make calls without interrupting your work thanks to Bluetooth connectivity.



LED display

Signals your current work mode, e.g. whether you are making a phone call or are available.

Unique function keys

Can be felt easily and can also be operated even when wearing gloves.

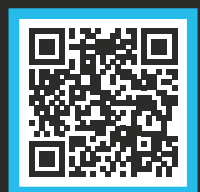

Hear what's important

The smart hearing protection for greater occupational safety



Outdoor microphones for secure communication

uvex aXess one are active electronic earmuffs with RAL function (real active listening). This function gives the user the feeling of not wearing hearing protection and of actively participating in the environment with hearing protection. This makes communication possible and warning signals can be perceived better. The volume of the ambient sounds can be set individually.

For safe hearing protection, the maximum output level is limited. The level gain below the sound level limiter is very helpful, for example when adjusting machines or performing diagnostic work.

Conveniently answer calls via Bluetooth®

uvex aXess one connects to your smartphone via Bluetooth 5.2, meaning you no longer miss important calls and can make them without interrupting your work. Dual mode allows you to add another device if needed.

Calls can be answered quickly and easily using the function keys on the earmuffs, so both hands are free when you make calls. The large radio range ensures that paired devices can remain in a protected location rather than at the workplace.



2640001



Protection against dust and moisture

Closure caps seal connector sockets.



uvex aXess hygiene kit

2592641
(catalogue page 111)



uvex aXess one

- active Bluetooth® earmuffs with foldable headband
- communication, telephony and streaming
- attenuation of harmful impulse noise
- real active listening function for clear perception of ambient noise
- buttons with a shape that corresponds to their function
- IP54 water and dust protected ideal for outdoor applications
- battery status indicator and battery warning message
- continuous length adjustment for the perfect positioning
- padded headband for a comfortable fit
- microphone covers can be used to minimise wind noise or provide additional protection

uvex aXess one	
Art. no.	2640001
Design	Active earmuffs with Bluetooth
SNR protection value	31 dB
H-M-L value	H: 37 dB, M: 29 dB, L: 21 dB
Weight	360 g
Colour	matt black, grey
Order unit	PC

Hearing Protection

Earmuffs – Tested in accordance with DIN EN 352-1



2000002



SNR
dB
30

2630010



SNR
dB
33

2630020



SNR
dB
36

2630030

Note: Order earmuff bag separately



uvex K10 · uvex K20 · uvex K30

- earmuffs with foldable headband
- variable length adjustment for easy positioning
- optimal earmuff shape for pressure-free protection of the outer ear
- padded headband for wearer comfort

- wearer comfort guaranteed thanks to extra-soft memory foam earmuff cushions, even when worn for long periods
- replaceable earmuff cushions for high hygiene requirements

Art. no.	uvex K10 2630010	uvex K20 2630020	uvex K30 2630030	uvex earmuff bag 2000002
Design	with foldable headband	with foldable headband	with foldable headband	with belt loop and hook-and-loop fastener
SNR protection value	30 dB	33 dB	36 dB	
H-M-L value	H: 35 dB, M: 28 dB, L: 19 dB	H: 36 dB, M: 32 dB, L: 22 dB	H: 37 dB, M: 34 dB, L: 26 dB	
Weight	185 g	230 g	385 g	
Colour	black, green	black, yellow	black, red	
Order unit	PC	PC	PC	PC

Hearing Protection

Earmuffs – Tested in accordance with DIN EN 352-1



2630011



uvex KX10

- earmuffs with rubberised surface
- increased grip and secure fit, ideal for oily or damp environments
- foldable headband
- variable length adjustment for easy positioning
- optimal earmuff shape for pressure-free protection of the outer ear
- padded headband for wearer comfort
- comfortable fit guaranteed thanks to extra-soft memory foam earmuff cushions, even when worn for long periods
- replaceable earmuff cushions for high hygiene requirements

uvex KX10	
Art. no.	2630011
Design	Hearing protection earmuffs with rubberised surface
SNR protection value	30 dB
H-M-L value	H: 35 dB, M: 28 dB, L: 19 dB
Weight	185 g
Colour	mat black, green
Order unit	PC



2630021



uvex K20 hi-viz

- earmuffs in fluorescent colours thanks to the high-visibility design
- foldable headband
- variable length adjustment for easy positioning
- optimal earmuff shape for pressure-free protection of the outer ear
- padded headband for wearer comfort
- comfortable fit guaranteed thanks to extra-soft memory foam earmuff cushions, even when worn for long periods
- replaceable earmuff cushions for high hygiene requirements

uvex K20 hi-viz	
Art. no.	2630021
Design	with foldable headband
SNR protection value	33 dB
H-M-L value	H: 36 dB, M: 32 dB, L: 22 dB
Weight	230 g
Colour	hi-viz
Order unit	PC

Hearing Protection

Earmuffs – Tested in accordance with DIN EN 352-1



2600001



2600002



2600003



2600004

uvex K1 · uvex K2 · uvex K3 · uvex K4

- earmuffs with length adjustment
- lightweight with a small cup
- easily adjustable for a perfect fit

- padded headband for optimum wearer comfort
- wearer comfort guaranteed thanks to extra-soft memory foam ear cushions, even when worn for long periods (excluding uvex K1)

	uvex K1	uvex K2	uvex K3	uvex K4
Art. no.	2600001	2600002	2600003	2600004
Design	with headband	with headband	with headband	with headband
SNR protection value	28 dB	32 dB	33 dB	35 dB
H-M-L value	H: 35 dB; M: 24 dB; L: 17 dB	H: 37 dB; M: 29 dB; L: 21 dB	H: 36 dB; M: 30 dB; L: 22 dB	H: 38 dB; M: 33 dB; L: 24 dB
Weight	180 g	217 g	297 g	356 g
Colour	black, green	black, yellow	black, red	neon lime
Order unit	PC	PC	PC	PC

Hearing Protection

Earmuffs – Tested in accordance with DIN EN 352-1



2600012

SNR
dB
31



SNR
dB
28



possible wearing styles



2600200

uvex K2 foldable

- dielectric earmuffs with length adjustment and foldable headband
- lightweight with a small cup
- extra-soft memory foam ear cushions for wearer comfort
- hi-vis design for improved wearer visibility

uvex K2 foldable	
Art. no.	2600012
Design	with foldable headband
SNR protection value	31 dB
H-M-L value	H: 35 dB, M: 29 dB, L: 21 dB
Weight	229 g
Colour	neon lime
Order unit	PC

uvex K200

- dielectric ear muffs with length adjustment
- suitable for use in workplace environments with exposure to electrical voltage
- adjustable headband for a perfect fit and optimum protection
- easily adjustable for a customised fit
- range of positions possible with 360° capsule rotation

uvex K200	
Art. no.	2600200
Design	with 360° headband rotatable
SNR protection value	28 dB
H-M-L value	H: 33 dB, M: 25 dB, L: 18 dB
Weight	173 g
Colour	black, ochre
Order unit	PC



2600000



2600010



2600011



2600013

SNR
dB
29

uvex K Junior

- earmuffs with shorter headband
- suitable for head widths up to 145 mm, equivalent to sizes S/M
- padded headband and soft cushions for optimum wearer comfort

uvex K Junior				
Art. no.	2600000	2600010	2600011	2600013
Design	with shorter headband	with shorter headband	with shorter headband	with shorter headband
SNR protection value	29 dB	EN 352-1	EN 352-1	EN 352-1
H-M-L value	H: 34 dB, M: 26 dB, L: 18 dB	H: 34 dB, M: 26 dB, L: 18 dB	H: 34 dB, M: 26 dB, L: 18 dB	H: 34 dB, M: 26 dB, L: 18 dB
Weight	167 g	167 g	167 g	167 g
Colour	yellow	blue	lime	pink
Order unit	PC	PC	PC	PC

Hearing Protection

Helmet earmuffs for 30-mm Euroslot – Tested in accordance with DIN EN 352-3



uvex K10H · uvex K20H · uvex K30H

- hearing protection earmuffs that can be attached to a safety helmet using the 30-mm Euroslot
- dielectric design
- soft, variable length adjustment
- sound isolation thanks to the rubber-cushioned earmuffs
- length is easily adjustable for a perfect fit on the helmet
- 360° rotation for standby and resting positions
- wearer comfort guaranteed thanks to extra-soft memory foam earmuff cushions, even when worn for long periods
- not compatible with the uvex pheos visor system

	uvex K10H	uvex K20H	uvex K30H
Art. no.	2630210	2630220	2630230
Design	dielectric helmet earmuffs for 30-mm Euroslot	dielectric helmet earmuffs for 30-mm Euroslot	dielectric helmet earmuffs for 30-mm Euroslot
SNR protection value	28 dB	30 dB	34 dB
H-M-L value	H: 34 dB; M: 26 dB; L: 18 dB	H: 34 dB; M: 28 dB; L: 20 dB	H: 36 dB; M: 32 dB; L: 24 dB
Weight	216 g	263 g	420 g
Colour	black, green	black, yellow	black, red
Order unit	PR	PR	PR

Hearing Protection

Helmet earmuffs for 30-mm Euroslot - Tested in accordance with DIN EN 352-3



2600201

SNR
dB
27



2600202

SNR
dB
30



uvex K1H · uvex K2H

- not compatible with the uvex pheos visor system
- length is easily adjustable for a perfect fit on the helmet
- 360° rotation for standby and resting positions
- soft ear cushions adapt to surface and head shape to ensure optimum wearer comfort (uvex K1H)

- wearer comfort guaranteed thanks to extra-soft memory foam ear cushions, even when worn for long periods (uvex K2H)

Art. no.	uvex K1H 2600201	uvex K2H 2600202
Design	helmet earmuffs for 30-mm Euroslot	helmet earmuffs for 30-mm Euroslot
SNR protection value	27 dB	30 dB
H-M-L value	H: 32 dB; M: 24 dB; L: 17 dB	H: 35 dB; M: 27 dB; L: 20 dB
Weight	210 g	251 g
Colour	black, green	black, yellow
Order unit	PR	PR

Customisation

All uvex earmuffs can be printed with your company logo and can also be colour-coded to suit your needs. Minimum order quantities apply.



uvex pheos alpine

uvex aXess one

Active Bluetooth helmet earmuffs

Tested in accordance with DIN EN 352-3, EN 352-4, EN 352-6, EN 352-8



Status messages

The audio assistant provides information via voice announcement ("Bluetooth connected")

RAL – real active listening

Active listening function with the ability to individually adjust the volume of ambient noise, no over-protection and no isolation from the environment



Hands-free telephony

Make calls without interrupting your work



Bluetooth® 5.2

Good sound quality, fast data transfer and a large range



Flexible spiral cable

Earmuffs can be moved to the resting position, regardless of the width of the helmet



uvex aXess one hygiene kit
2592641

LED display

Indicates the current work mode

Unique function keys

Easy to use, even when wearing gloves

IP54 protection class (dust-tight and water-proof)

Suitable for use in dusty and damp working conditions thanks to sealing caps.



External audio input

3.5 mm audio input, for example, for wireless devices

USB Type-C charging socket

Fast charging time, easy handling, flexible charging options



External microphones for reliable communication

uvex aXess one are active electronic earmuffs with RAL function (real active listening). This function makes the user feel like they are not wearing hearing protection, which in turn allows them to actively participate in the environment despite wearing earmuffs. Users are still able to communicate with others and can react effectively to warning signals. The volume of the transmitted ambient noise can be individually adjusted in 5 increments. This means that there is no over-protection, even in low-noise environments from 85 dB. Low noise levels below 82 dB can even be amplified. To ensure safe hearing protection, the maximum output level is limited.

Conveniently answer calls via Bluetooth®

uvex aXess one connects to your smartphone via Bluetooth 5.2, meaning you no longer miss important calls and can make them without interrupting your work. Dual mode allows you to add another device if needed.

Calls can be answered quickly and easily using the function keys on the earmuffs, leaving both hands free when you make calls.



uvex aXess one — system combinations

Perceive ambient noise while still being protected

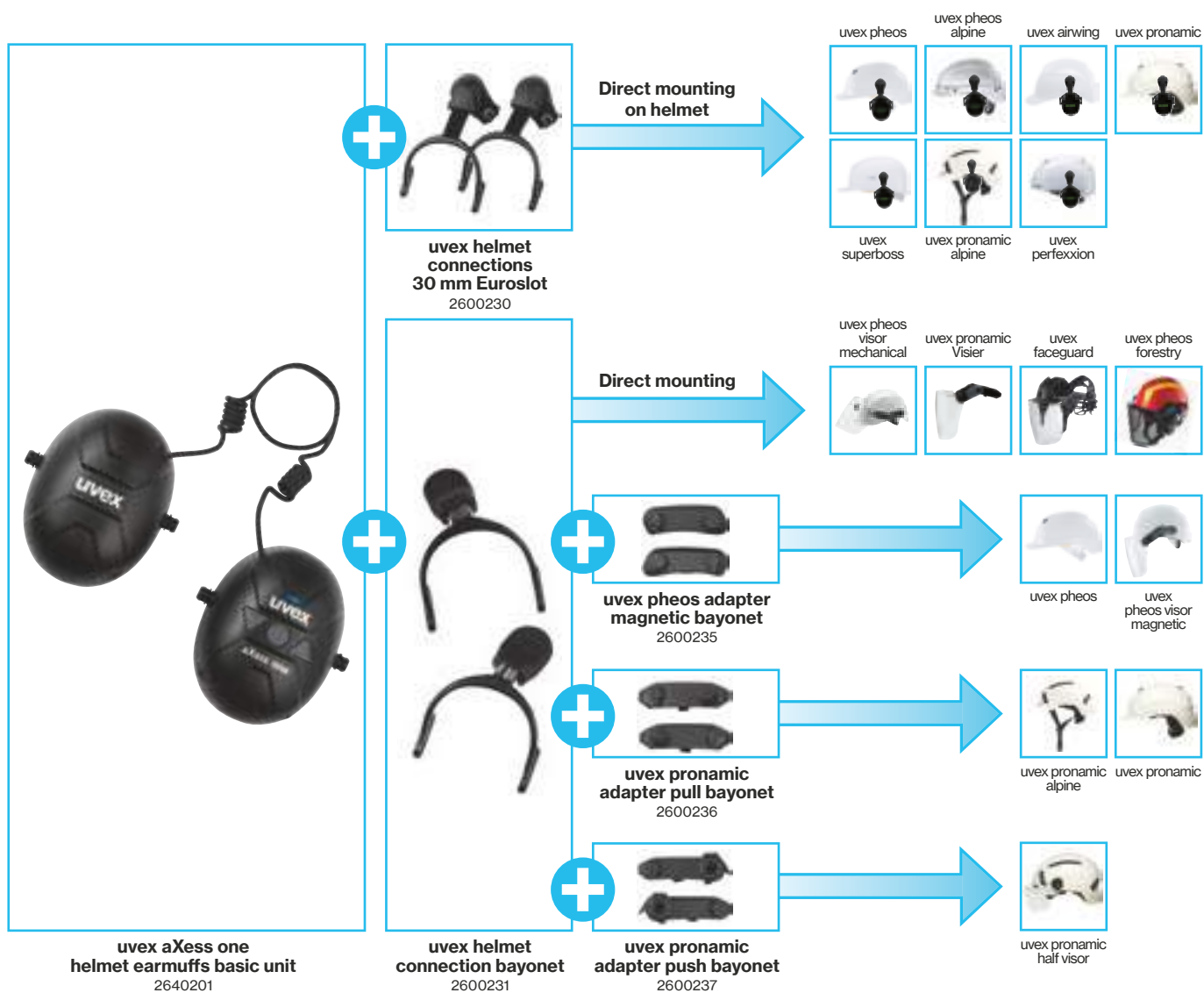

uvex aXess one helmet earmuffs

- active Bluetooth® earmuffs for attaching to the helmet
- two helmet connections available, uvex bayonet/30 mm Euroslot
- noise insulation thanks to the rubber-cushioned earmuffs
- communication, telephony and audio streaming
- attenuation of harmful impulse noise
- no over-protection, can be used from 80 dB
- real active listening function for clear perception of ambient noise. Low noise levels can be amplified

- buttons with a shape that corresponds to their function
- IP54 water and dust protection, ideal for outdoor applications
- battery status indicator and battery warning message
- continuous length adjustment for perfect positioning
- microphone covers can be used to minimise wind noise or provide additional protection

	uvex aXess one helmet earmuffs Basic unit	Earmuffs Helmet connection	Earmuffs Helmet connection bayonet	uvex pheos adapter Magnetic bayonet	uvex pronamic adapter Pull bayonet	uvex pronamic adapter Push bayonet
Art. no.	2640201	2600230	2600231	2600235	2600236	2600237
Design	Active helmet earmuffs basic unit	30 mm Euroslot helmet connection	uvex bayonet helmet connection	For use with the magnetic pheos visors and the uvex earmuffs with bayonet connection	Helmet connection for use with full visors and the uvex earmuffs with bayonet connection	Helmet connection for use with half visors and the uvex earmuffs with bayonet connection
Weight	309 g	99 g	69 g			
Colour	black, grey					
Order unit	PC	PR	PR	PR	PR	PR

Hearing Protection

uvex helmet earmuffs for uvex system combinations – Tested in accordance with DIN EN 352-3



SNR
dB
28

2600216



SNR
dB
30

2600214
2600215

uvex K1P · uvex K2P

- for use only with uvex helmets in combination with uvex helmet adapters or a pre-mounted visor system
- the soft foam ear cushion of the K1P adapts to the wearer's head shape to ensure optimum wearer comfort
- the K2P guarantees a comfortable fit thanks to extra-soft memory foam earmuff cushions, even when worn for long periods
- 360° rotation for standby and resting positions

- both variants are available in a bayonet version and can be attached and removed quickly and easily without tools
- K2P available as a magnetic variant so the earmuffs can be quickly and easily attached and removed without having to take off the helmet
- easy, convenient height adjustment of earmuffs
- dielectric

Art. no.	uvex K1P bayonet 2600216	uvex K2P bayonet 2600214	uvex K2P magnetic 2600215
Design	bayonet connection	bayonet connection	magnetic connection
SNR protection value	28 dB	30 dB	30 dB
H-M-L value	H: 34 dB, M: 25 dB, L: 18 dB	H: 35 dB, M: 27 dB, L: 20 dB	H: 35 dB, M: 27 dB, L: 20 dB
Weight	191 g	235 g	240 g
Colour	black, grey	black, yellow	black, yellow
Order unit	PR	PR	PR



Magnetic locking system
for visor and earmuffs

uvex magnetic connection system

The unique magnetic locking system allows the earmuffs and visor to be attached or removed without tools. This allows the helmet to conveniently stay on your head and means you remain protected. Easily and quickly adjust your system to your requirements.

uvex bayonet connection system

The bayonet connection allows the earmuffs to be attached or removed without tools. Easily and quickly adjust your system to your requirements.

Hearing Protection

Helmet earmuffs – Assembly matrix

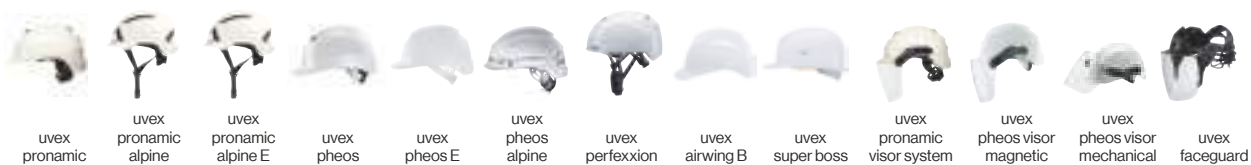

	uvex pronamic	uvex pronamic alpine	uvex pronamic alpine E	uvex pheos	uvex pheos E	uvex pheos alpine	uvex perfoxion	uvex airwing B	uvex super boss	uvex pronamic visor system	uvex pheos visor magnetic	uvex pheos visor mechanical	uvex faceguard
uvex K1H (2600201)	■	■	–* ⁽¹⁾	■	–* ⁽¹⁾	■	■	■	■	–	–	–	–
uvex K2H (2600202)	■	■	–* ⁽¹⁾	■	–* ⁽¹⁾	■	■	■	■	–	–	–	–
uvex K10H (2630210)	■	■	■	■	■	■	■	■	■	–	–	–	–
uvex K20H (2630220)	■	■	■	■	■	■	■	■	■	–	–	–	–
uvex K30H (2630230)	■	■	■	■	■	■	■	■	■	–	–	–	–
uvex K1P bayonet (2600216)	■	■ With pronamic adapter pull bayonet 2600236 or pronamic visor	■	■	■ With pheos adapter magnetic bayonet 2600235 or mechanical visor	■	–	–	–	■	–	■	■
uvex K2P bayonet (2600214)	■	■ With pronamic adapter pull bayonet 2600236 or pronamic visor	■	■	■ With pheos adapter magnetic bayonet 2600235 or mechanical visor	■	–	–	–	■	–	■	■
uvex K2P magnet (2600215)	–	–	–	■	■ With pheos helmet adapter magnetic 9790078	■	–	–	–	–	■	–	–
uvex aXess one Helmet earmuffs (2640201)	■	■ With helmet connection 30 mm slot 2600230	■	■	■ With helmet connection 30 mm slot 2600230	■	■	■ With helmet connection 30 mm slot 2600230	■	■ With helmet connection bayonet 2600231 and pronamic adapter pull bayonet 2600236 or pronamic visor	■ With helmet connection bayonet 2600231 and pheos adapter magnetic bayonet 2600235	■	■ With helmet connection bayonet 2600231

*⁽¹⁾ non-dielectric

- 9790078 uvex pheos adapter magnetic
- 2600235 uvex pheos adapter magnetic bayonet
- 2600236 uvex pronamic adapter pull bayonet
- 2600230 Earmuffs helmet connection 30 mm slot
- 2600231 Earmuffs helmet connection bayonet



Example:

uvex pronamic B-WR (9731030) + uvex K2P bayonet (2600214) + uvex pronamic mesh visor (9916100) = uvex pronamic system

Hearing Protection

Earplug accessories



6177116

uvex clear otoplastics

- silicone-free towelettes for quick and easy cleaning of reusable ear plugs

uvex clear otoplastics	
Art. no.	6177116
Content	30 towelettes per PC
Order unit	PC



2111404

uvex earplug box

- box for hygienic earplug storage
- compact and dirt-resistant design
- for one pair of reusable earplugs with cord
- or two pairs of reusable earplugs without cord

uvex earplug box	
Art. no.	2111404
Design	earplugs not included
Colour	transparent
Content	50 PC per Box
Order unit	CT



2134000

Wall bracket for dispenser box

- plexiglas wall-mounted dispenser, suitable for uvex x-fit (2112001, 2112010, 2112011), uvex com4-fit (2112004, 2112012), uvex one-fit (2112045), uvex xtra-fit (2112060), uvex hi-com (2112100, 2112101, 2112106, 2112114).

Wall bracket for dispenser box	
Art. no.	2134000
Material	PMMA
Colour	transparent
Order unit	PC



Hearing protection tester box

- Find the perfect hearing protection for you:
- box containing selection of uvex disposable/reusable and detectable hearing protection earplugs plus uvex xact-band banded ear protectors
 - article number: 1000929



Usage poster

- Article numbers
- 1001.165 (German)
 - 1001.166 (English)
 - Size: A2



Hearing protection guide

- 25 pages
- with Euro holes
- includes all essential information about hearing protection
- art. no.: 1001.214 (German)
- art. no.: 1001.215 (English)

Hearing protection

Earmuff accessories



2592641

uvex aXess series hygiene kit

uvex aXess series hygiene kit	
Art. no.	2592641
Design	for uvex aXess earmuff series
Order unit	BG
Content	2 earmuff cushions, 2 absorber cushions, 2 inner cushions, 3 microphone covers



2599978

uvex K series comfort pads "uvex dry pads"

- accessories for all models in the uvex K series
- the comfort pads can be attached to the sealing cushions to absorb moisture and sweat

uvex K series comfort pads "uvex dry pads"	
Art. no.	2599978
Design	self-adhesive, suitable for all models in the uvex K series
Content	10 Pads in BG
Order unit	BG



2599971
2599972

uvex K series · Hygiene kits

	uvex K series hygienekit standard	uvex K series hygienekit-premium
Art. no.	2599971	2599972
Design	accessories for uvex K1, uvex K1H, uvex K1P, uvex K200, uvex K junior	accessories for uvex K2, uvex K2 foldable, uvex K3, uvex K4, uvex K10, uvex KX10, uvex K20, uvex K30, uvex K2H, uvex K2P, uvex K10H, uvex K20H, uvex K30H, uvex aXess one
Content	2 ear pads and 2 muffling pads in BG	in BG
Order unit	BG	BG

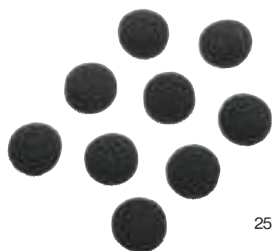

2592640

uvex microphone cover

uvex microphone cover	
Art. no.	2599978
Design	Set of nine, self-adhesive, suitable for the uvex aXess series
Order unit	BG



2000002

uvex earmuff bag

uvex earmuff bag	
Art. no.	2000002
Design	with belt loop and hook-and-loop fastener
Size	150x120x120 mm
Order unit	PC



2000000

Storage box for earmuffs

Storage box for earmuffs	
Art. no.	2000000
Design	Plastic storage box
Size	236x225x125 mm
Order unit	PC

Hearing Protection

Overview

Art. no.	Name	Product	Colour	Content	Page
2000000		Storage box	blue	PC	111
2000002		Earmuff bag		PC	100/111
2111201	uvex whisper	Reusable earplugs with cord in a mini box	orange	50 PR, in pairs in CT	93
2111212	uvex whisper+	Reusable earplugs with cord in a mini box	lime	50 PR, in pairs in CT	93
2111235	uvex whisper supreme	Reusable earplugs with cord in earplug box	yellow	50 PR, in pairs in CT	93
2111237	uvex whisper	Reusable earplugs with cord in earplug box	orange	50 PR, in pairs in CT	93
2111238	uvex whisper+	Reusable earplugs with cord in earplug box	lime	50 PR, in pairs in CT	93
2111239	uvex whisper+ detec	Detectable reusable earplugs with cord in earplug box	blue	50 PR, in pairs in CT	95
2111260	uvex whisper+ detec	Reusable earplugs with cord in a mini box		50 PR, in pairs in CT	95
2111261	uvex whisper detec	Reusable earplugs with cord in a mini box		50 PR, in pairs in CT	95
2111262	uvex whisper detec	Reusable earplugs with cord in a mini box		50 PR, in pairs in CT	95
2111404		uvex earplug box	transparent	CT	110
2111988	one 2 click	dispenser, empty, magnetic		CT	90
2111989		Magnetic wall bracket for dispenser		CT	90
2111990	one 2 click	Dispenser filled with 600 pairs of x-fit earplugs		600 PR, x-fit	90
2111991	one 2 click	Dispenser filled with 600 pairs of com4-fit earplugs		600 PR, xcom4-fit	90
2111992	one 2 click	Dispenser filled with 600 pairs of hi-com earplugs		600 PR, hi-com	90
2112000	one 2 click	Dispenser for 600 pairs of earplugs, empty		CT	90
2112001	uvex x-fit	Disposable earplugs without cord	lime	200 PR, packed in pairs in CT	89
2112004	uvex com4-fit	Disposable earplugs without cord	light orange	200 PR, packed in pairs in CT	89
2112010	uvex x-fit	Disposable earplugs with cord	lime	100 PR, packed in pairs in CT	89
2112011	uvex x-fit detec	Detectable disposable earplugs with cord	blue	100 PR, in pairs in CT	94
2112012	uvex com4-fit	Disposable earplugs with cord	light orange	100 PR, packed in pairs in CT	89
2112013	uvex x-fit	Disposable earplugs without cord		50 PR, loose in CT	89
2112022	uvex x-fit	Refill box	lime	300 PR, loose in CT	90
2112023	uvex com4-fit	Refill box	light orange	300 PR, loose in CT	90
2112060	uvex xtra-fit	Disposable earplugs without cord	orange	200 PR, packed in pairs in BG	89
2112061	uvex xtra-fit	Refill box	orange	250 PR, loose in BG	90
2112087	uvex x-fit	Disposable earplugs without cord	lime	100 PR, packed in pairs in CT	89
2112093	uvex xtra-fit	Minidispenser Box	orange	100 PR, packed in pairs in CT	89
2112094	uvex x-fit	Minidispenser Box	lime	100 PR, packed in pairs in CT	89
2112095	uvex hi-com	Minidispenser Box	lime	100 PR, packed in pairs in CT	88
2112096	uvex com4-fit	Minidispenser Box	light orange	100 PR, packed in pairs in CT	89
2112100	uvex hi-com	Disposable earplugs without cord	lime	200 PR, packed in pairs in CT	88
2112101	uvex hi-com	Disposable earplugs with cord	lime	100 PR, packed in pairs in CT	88
2112106	uvex hi-com	Disposable earplugs without cord	beige	200 PR, packed in pairs in CT	88
2112114	uvex hi-com detec	Detectable disposable earplugs with cord	blue	100 PR, in pairs in CT	88
2112118	uvex hi-com	Refill box	lime	300 PR, loose in CT	90
2112119	uvex hi-com	Refill box	beige	300 PR, loose in CT	90
2112131	uvex com4-fit	Disposable earplugs without cord	light orange	15 PR, loose in CT	89
2112133	uvex x-fit	Disposable earplugs without cord		15 PR, loose in CT	89
2124001	uvex xact-fit	Earplugs with cord and pin	lime, grey	50 PR, packed in pairs in CT	92
2124002	uvex xact-fit	Replacement earplugs	lime	250 PR, CT of 5 pairs	92/96
2124003	uvex xact-fit	Refill box	lime	400 PR, loose in CT	92/96
2124011	uvex xact-fit detec	Detectable earplugs with pin	blue	50 PR, in pairs in CT	94
2124013	uvex xact-fit detec	Replacement earplugs	blue	400 PR, loose in CT	94
2124017	uvex xact-fit multi reusable S	Reusable earplugs with oval-shaped reusable plugs	grey, transparent	50 PR, packed in pairs in CT	92
2124018	uvex xact-fit multi reusable M/L	Reusable earplugs with oval-shaped reusable plugs	grey, transparent	50 PR, packed in pairs in CT	92
2124019	uvex xact-fit multi reusable S	Reusable earplugs with oval-shaped reusable plugs	grey, transparent	50 PR, packed in pairs in CT	92
2124020	uvex xact-fit multi reusable M/L	Reusable earplugs with oval-shaped reusable plugs	grey, transparent	50 PR, packed in pairs in CT	92
2124026	uvex xact-fit planet	Earplugs with pin	lime	50 PR, packed in pairs in CT	92
2124099	uvex xact-fit test	Bluetooth-capable headphones		PC	91
2124097	uvex xact-fit travel suitcase	accessories for uvex xact-fit test		PC	91
2124098	uvex hygiene kit	accessories for uvex xact-fit test earmuffs		PC	91
2125344	uvex x-fold	Folding banded ear protector	grey, sky blue, lime	5 PC, individually packed in CT	96
2125351		Replacement earplugs for uvex x-cap and uvex x-fold	sky blue, lime	60 PR, CT of 5 pairs	96
2125361	uvex x-cap	Banded ear protector	grey, sky blue, lime	15 PC, individually packed in CT	96
2125372	uvex xact-band	Banded ear protector	grey, sky blue, lime	5 PC, individually packed in CT	96
2134000		Wall-mounted dispenser		PC	110
2592640		Microphone cover	black	BG	111
2599971		Hygiene kit uvex K series standard		2 ear pads and 2 muffling pads in BG	111
2599972		Hygiene kit uvex K series premium		2 ear pads and 2 muffling pads in BG	111
2599978		Comfort pads		10 Pads in BTL	111
2600000	uvex K junior yellow	Passive earmuffs	yellow, black	PC	103
2600001	uvex K1	Passive earmuffs	black, green	PC	102
2600002	uvex K2	Passive earmuffs	black, yellow	PC	102
2600003	uvex K3	Passive earmuffs	black, red	PC	102
2600004	uvex K4	Passive earmuffs	neon lime	PC	102
2600010	uvex K junior blue	Passive earmuffs	blue	PC	103
2600011	uvex K junior green	Passive earmuffs	lime	PC	103
2600012	uvex K2 foldable	Passive earmuffs	neon lime	PC	103
2600013	uvex K junior pink	Passive earmuffs	pink	PC	103
2600200	uvex K200	Passive earmuffs	black, ochre	PC	103
2600201	uvex K1H	Earmuffs with helmet attachment	black, green	PR	105
2600202	uvex K2H	Earmuffs with helmet attachment	black, yellow	PR	105
2600214	uvex K2P bayonet	Earmuffs with helmet attachment	black, yellow	PR	108
2600215	uvex K2P magnet	Earmuffs with helmet attachment	black, yellow	PR	108
2600216	uvex K1P bayonet	Earmuffs with helmet attachment	black, grey	PR	108
2600230	Helmet connection 30 mm slot	30 mm Euroslot helmet connection		PR	107
2600231	Helmet connection bayonet	uvex bayonet helmet connection		PR	107
2600235	uvex pheos adapter	uvex adapter magnetic bayonet		PR	107
2600236	uvex pronamic adapter	uvex adapter pull bayonet		PR	107
2600237	uvex pronamic adapter	uvex adapter push bayonet		PR	107
2630010	uvex K10	Earmuffs with helmet attachment	black, green	PC	100
2630011	uvex KX10	Earmuffs with helmet attachment	matt black, green	PC	101
2630020	uvex K20	Earmuffs with helmet attachment	black, yellow	PC	100
2630021	uvex K20 hi-viz	Earmuffs with helmet attachment	hi-viz	PC	101
2630030	uvex K30	Earmuffs with helmet attachment	black, red	PC	100
2630210	uvex K10H	Earmuffs with helmet attachment	black, green	PC	104
2630220	uvex K20H	Earmuffs with helmet attachment	black, yellow	PC	104
2630230	uvex K30H	Earmuffs with helmet attachment	black, red	PC	104
2640001	uvex aXess one	Active earmuffs	matt black, grey	PC	99
2640201	uvex aXess one helmet earmuffs	Active helmet earmuffs basic unit	black, grey	PC	107
6177116	uvex clear otoplastics	silicone-free towelettes		30 towelettes, PC	110
9790078		Helmet adapter	black	PR	109



Safety Helmets

Product system planet series › Visors

uvex has developed the **protecting planet** icon, to help raise awareness of its commitment to achieving increased sustainability. Based on the brand claim, **protecting people**, our sustainable approach integrates three core interlinked pillars – **ecology, economy** and **social responsibility**, that are incorporated throughout the business to improve our sustainability performance.

This explains the comprehensive audit, measurement and evaluation management process uvex undertakes along the entire value chain to ensure its products are as sustainable as possible.

uvex pronamic

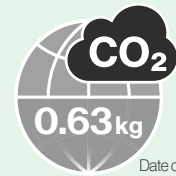

Date created 06/2023*

MADE IN GERMANY

protecting planet
by using recycled material

Visor system

- › visor lens made of up to 100 percent mass-balanced** polycarbonate
- › visor arms made of up to 85 percent recycled plastic (made of high-quality post-industrial and post-consumer materials)
- › reduction in CO₂ emissions by over 50 percent

protecting planet
by using environmentally-friendly packaging

Instructions for use

- › made from waste paper

Packaging

- › CO₂-offset polybag
- › clean disposal and return to the recycling process possible

CO₂ emissions

50%
saving

100%

mass-balanced**
polycarbonate
per lens



9916000

85%

recycled plastic in the
visor arms

** Mass-balanced products are products where **traceable** bio-based raw materials or primary products **have been used in the production process** within a specified scope **without** biogenic carbon **being reliably detectable in the final product**. Mass balancing is a bookkeeping method (e.g. for the proportion of recycled materials) used to record and track mass flows of plastics along the entire value creation chain. This allows sources of fossil-based raw materials to be removed from the production process, for example by removing CO₂, biomass or secondary raw materials from chemical recycling. As the mass balancing approach is a bookkeeping method, the exact percentage of recycled material in the product cannot be determined precisely.

Standards at a glance

EN 397 · EN 50365

EN 397 – Industrial safety helmets















Protection against falling objects and the consequences thereof, such as brain damage and skull fracture

Binding requirements: all helmets certified according to EN 397 must meet these requirements.

- shock absorption, vertical
- penetration resistance (against sharp and pointed objects)
- flame resistance
- chin strap attachment: chin strap releases at minimum 150 N and maximum 250 N

Optional requirements: a helmet certified in accordance with EN 397 may meet these requirements; they are, however, not mandatory requirements.

- very low temperatures (-20°C or -30°C)
- very high temperatures (+150°C)
- electrical insulation (440 V)
- molten metal (MM)
- lateral deformation (LD)

very low temperatures (-20°C or -30°C)	 uvex airwing	 uvex super boss	 uvex pheos	 uvex pheos alpine	 uvex perfexxion	 uvex pronamic alpine	 uvex pronamic
very high temperatures (+150°C)		 uvex thermo boss					
electrical insulation (440 V)	 uvex airwing E	 uvex thermo boss					
molten metal (MM)			 uvex pheos			 uvex pronamic alpine	 uvex pronamic
lateral deformation					 uvex perfexxion	 uvex pronamic alpine	

EN 50365 – Insulating helmets for use on low voltage installations

Protection against electric shocks and prevention of dangerous electric current passing through the head

Requirements:

- All helmets must also meet the requirements in accordance with EN 397.
- Protection against alternating voltage of up to 1000 V (AC) or direct voltage up to 1500 V (DC)
- Insulating helmets must not contain any conductive parts.
- Air vents (if available) must not allow any accidental contact with live parts.



uvex pheos E



uvex pronamic alpine E

Overview of standards

EN 12492 · EN 1078

EN 12492 – Helmets for mountaineers

Protection against hazards that may occur during activities undertaken by mountaineers

Requirements:

- Shock absorption, vertical, frontal, lateral, dorsal
- Penetration resistance
- Carrier element (chin strap releases at min. 500 N)
- Strength of carrier element: Chin strap may exhibit maximum elongation of 25 mm
- Carrier element effectiveness: Helmet must not slide from the head



uvex pheos alpine

uvex perffxion

uvex pronamic alpine



EN 1078: Cycling helmet

Helmets for pedal cyclists and for users of skateboards and roller skates

Requirements:

- absorbs impact from vertical force
- the effectiveness of the retention system must be ensured via a retention test
- the mechanical strength of the chin strap must be ensured – the maximum permissible elongation is 35 mm



uvex perffxion



uvex pronamic

The innovative multi-functional helmet

Perfect interplay of protection and dynamic

The modern, sporty uvex pronamic has a unique, innovative helmet structure. Taking inspiration from bionics (namely, the lily pad), a completely new helmet design has been brought to life – for increased performance, better ergonomics and a more sustainable use of materials. The uvex pronamic offers maximum protection: It meets both the requirements of necessary standards (shock absorption, penetration, flammability) and optional requirements (" -30°C", MM).

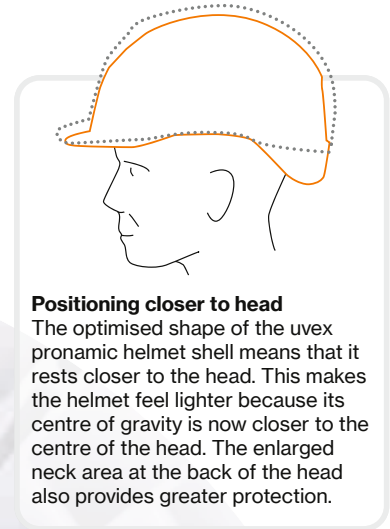

Positioning closer to head

The optimised shape of the uvex pronamic helmet shell means that it rests closer to the head. This makes the helmet feel lighter because its centre of gravity is now closer to the centre of the head. The enlarged neck area at the back of the head also provides greater protection.

Maximum ventilation

The fully integrated ventilation sliders are easy to operate even when wearing gloves.



brim long brim short

Optimal vision

The long brim protects against sunlight, while the short brim expands the field of vision.



Space for accessories

There is a wide range of accessories available for the uvex pronamic, such as a half visor.



IES system – Now as standard

Safety spectacles can be conveniently stored in the resting position in the helmet – now integrated as standard. Spectacle clip (9772002) required.

Integrated neck piece

The ergonomic spiderneck neck piece enlarges the contact surface at the back of the head and provides increased wearer comfort, especially when carrying out work above head height.

Extended size range

Variable size adjustment from 51 to 65 cm.



Integrated neck piece

The ergonomic spiderneck neck piece enlarges the contact surface at the back of the head and provides increased wearer comfort, especially when carrying out work above head height.



Robust, lightweight structure

The newly developed design of the inside of the helmet saves material without sacrificing stability.



uvex pronamic

uvex pronamic B-WR · pronamic B-S-WR · pronamic S-KR



9731030



9731130



9731330



9731530

uvex pronamic B-WR

- side Euroslot adapters (30 mm) for attaching earmuffs and visor
- additional elements allow a wide range of accessories to be attached to the helmet
- adjustable air vents for maximum ventilation
- suspension harness (9790310) fitted with wheel ratchet system for variable width adjustment
- fitted with sweatband (9790311)
- six-point textile band attachment ensures an optimal fit and maximum comfort
- adapter for the IES spectacle clip (9772002) included as standard

uvex pronamic B-WR				
Art. no.	9731030	9731130	9731330	9731530
Colour	white	yellow	red	blue
Version	with long brim			
Material	HDPE	HDPE	HDPE	HDPE
Standard	EN 397	EN 397	EN 397	EN 397
	-30 °C, MM	-30 °C, MM	-30 °C, MM	-30 °C, MM
Sizes	51 to 65 cm	51 to 65 cm	51 to 65 cm	51 to 65 cm
Order unit	PC	PC	PC	PC
Outer packaging	25 PC per CT	25 PC per CT	25 PC per CT	25 PC per CT



9731031



9731131



9731331



9731531

uvex pronamic B-S-WR

- shorter brim for a wider field of vision
- side Euroslot adapters (30 mm) for attaching earmuffs and visor
- additional elements allow a wide range of accessories to be attached to the helmet
- adjustable air vents for maximum ventilation
- suspension harness (9790310) fitted with wheel ratchet system for variable width adjustment
- fitted with sweatband (9790311)
- six-point textile band attachment ensures an optimal fit and maximum comfort
- adapter for the IES spectacle clip (9772002) included as standard

uvex pronamic B-S-WR				
Art. no.	9731031	9731131	9731331	9731531
Colour	white	yellow	red	blue
Version	with short brim			
Material	HDPE	HDPE	HDPE	HDPE
Standard	EN 397	EN 397	EN 397	EN 397
	-30 °C, MM	-30 °C, MM	-30 °C, MM	-30 °C, MM
Sizes	51 to 65 cm	51 to 65 cm	51 to 65 cm	51 to 65 cm
Order unit	PC	PC	PC	PC
Outer packaging	25 PC per CT	25 PC per CT	25 PC per CT	25 PC per CT



9731033



9731133



9731333



9731533

uvex pronamic S-KR

- pre-mounted four-point forked chin strap (9790021)
- attachment clip (9790022) for positioning the forked chin strap in the resting position
- shorter brim for a wider field of vision
- side Euroslot adapters (30 mm) for attaching earmuffs and visor
- additional elements allow a wide range of accessories to be attached to the helmet
- adjustable air vents for maximum ventilation
- suspension harness (9790310) fitted with wheel ratchet system for variable width adjustment
- fitted with sweatband (9790311)
- six-point textile band attachment ensures an optimal fit and maximum comfort
- adapter for the IES spectacle clip (9772002) included as standard

uvex pronamic S-KR				
Art. no.	9731033	9731133	9731333	9731533
Colour	white	yellow	red	blue
Version	with short brim			
Material	HDPE	HDPE	HDPE	HDPE
Standard	EN 397	EN 397	EN 397	EN 397
	-30 °C, MM	-30 °C, MM	-30 °C, MM	-30 °C, MM
Sizes	51 to 65 cm	51 to 65 cm	51 to 65 cm	51 to 65 cm
Order unit	PC	PC	PC	PC
Outer packaging	25 PC per CT	25 PC per CT	25 PC per CT	25 PC per CT

MADE IN GERMANY



Safety Helmets

uvex pronamic alpine



Generous ventilation

The side air vents significantly improve the temperature inside the helmet.



Closed version

This version also offers optimal protection for work in low-voltage areas. It fully complies with EN 397, EN 50365 and EN 12492 except point 4.1.4 (ventilation).



Optimal adjustment

The wheel ratchet system provides plenty of scope for adjustments and the suspension harness inside the helmet can be adjusted as desired to provide the perfect fit for the wearer's head shape



EN 12492 and EN 397

The best equipment for various applications. Whether used while working at height or as an industrial safety helmet, the helmet's chin strap system is quick and easy to change, enabling the helmet to fulfil the safety standards for both applications and offer optimum protection at all times



MIPS included

An additional MIPS inner shell can be integrated as an option to absorb rotational energy, reducing the force transferred to the wearer's head. A detailed description of how the MIPS safety system works can be found on page 123.



Accessories can be fitted easily and quickly

The four stylistic retaining clips guarantee an optimal fit of the helmet accessories. This ensures that the user has access to any necessary application-related products, such as helmet torches or goggles, and that these are in the perfect position at all times.



Further information can be found at uvex-safety.com/en/uvex-pronamic-alpine (or scan the QR code).

Safety Helmets

uvex pronamic alpine · pronamic alpine E



9735030



9735130



9735230

LD-tested



uvex pronamic alpine

- multi-standard helmet that meets the requirements of EN 397 and EN 12492
- patented MIPS inner shell available as an option
- side Euroslot adapters (30 mm) for attaching earmuffs and visor
- four retaining clips for fitting head torches or goggles
- additional elements allow our wide range of accessories to be attached to the helmet
- air vents for maximum ventilation

- versatile and adjustable suspension harness with variable wheel ratchet system
- EPS inner shell ensures excellent fit and comfort
- EN 12492 forked chin strap (art. no. 9790351) included in the standard scope of delivery, EN 397 version (art. no. 9790021) sold separately as an accessory
- replaceable hygiene kits 9790350 and 9790352 (MIPS)



uvex pronamic alpine						
Art. no.	9735030	9735130	9735230	9735031	9735131	9735231
Colour	white	hi-viz yellow	hi-viz orange	white	hi-viz yellow	hi-viz orange
Version				Mips	Mips	Mips
Material	ABS	ABS	ABS	ABS	ABS	ABS
Standard	EN 12492, EN 397 -30°C, MM, LD	EN 12492, EN 397 -30°C, MM, LD	EN 12492, EN 397 -30°C, MM, LD	EN 12492, EN 397 -30°C, MM, LD	EN 12492, EN 397 -30°C, MM, LD	EN 12492, EN 397 -30°C, MM, LD
Sizes	51 to 63 cm	51 to 63 cm	51 to 63 cm	51 to 63 cm	51 to 63 cm	51 to 63 cm
Order unit	PC	PC	PC	PC	PC	PC
Outer packaging	8 PC per CT	8 PC per CT	8 PC per CT	8 PC per CT	8 PC per CT	8 PC per CT



9736030



9736130



9736230

LD-tested

uvex pronamic alpine E

- multi-standard helmet that meets the requirements of EN 397, EN 50365 and EN 12492 (except ventilation 4.1.4)
- patented MIPS inner shell available as an option
- side Euroslot adapters (30 mm) for attaching earmuffs and visor
- four retaining clips for fitting head torches or goggles
- additional elements allow our wide range of accessories to be attached to the helmet

- versatile and adjustable suspension harness with variable wheel ratchet system
- EPS inner shell ensures excellent fit and comfort
- forked chin strap EN 12492 (art. no. 9790351) included in the standard scope of delivery, EN 397 version (art. no. 9790021) sold separately as an accessory
- replaceable hygiene kits 9790350 and 9790352 (MIPS)

uvex pronamic alpine E						
Art. no.	9736030	9736130	9736230	9736031	9736131	9736231
Colour	white	hi-viz yellow	hi-viz orange	white	hi-viz yellow	hi-viz orange
Version				Mips	Mips	Mips
Material	ABS	ABS	ABS	ABS	ABS	ABS
Standard	EN 50365 EN 12492 (except 4.1.4) EN 397	EN 50365 EN 12492 (except 4.1.4) EN 397	EN 50365 EN 12492 (except 4.1.4) EN 397	EN 50365 EN 12492 (except 4.1.4) EN 397	EN 50365 EN 12492 (except 4.1.4) EN 397	EN 50365 EN 12492 (except 4.1.4) EN 397
	-30 °C, MM, LD	-30 °C, MM, LD	-30 °C, MM, LD	-30 °C, MM, LD	-30 °C, MM, LD	-30 °C, MM, LD
Sizes	51 to 63 cm	51 to 63 cm	51 to 63 cm	51 to 63 cm	51 to 63 cm	51 to 63 cm
Order unit	PC	PC	PC	PC	PC	PC
Outer packaging	8 PC per CT	8 PC per CT	8 PC per CT	8 PC per CT	8 PC per CT	8 PC per CT

Safety Helmets

uvex pheos S-KR Mips



MIPS inner shell

The additional MIPS safety system is integrated into the suspension harness.



Large neck piece

The additional neck piece increases the contact surface, reducing pressure on the back of the wearer's head. This improves the wearing comfort.



Pre-mounted forked chin strap

The comfortable forked chin strap secures the helmet and guarantees optimum protection, especially when carrying out overhead work

Safety Helmets

uvex pheos S-KR Mips

What is MIPS?

The MIPS safety system is designed to provide additional protection for helmets during a wide variety of accidents. In certain impact situations, the MIPS system can reduce dangerous forces that might otherwise be transferred to the helmet wearer's head.

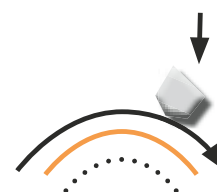
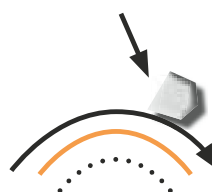
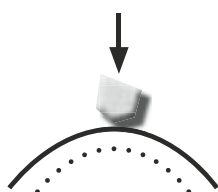

Linear impacts

Conventional helmets are designed and tested for linear impacts. In most cases, however, impacts occur at an angle and lead to a rotational movement of the head.

Angled impacts

The low-friction inner shell is designed to help reduce the rotational forces acting on the head in certain cases of an angled impact.



Further information can be found at uvex-safety.com/en/mips/ (or scan the QR code).



9772090



9772190



9772260

uvex pheos S-KR Mips

- safety helmet with slots for uvex visors, helmet earmuffs and helmet torches
- MIPS inner shell absorbs rotational forces
- three adjustable air vents for maximum ventilation
- suspension harness with wheel ratchet system for variable width adjustment
- six-point textile band attachment ensures excellent fit and comfort
- pre-mounted forked chin strap (9790021)
- large neck piece (9790149) increases wearing comfort
- fitted with a sweatband (9760260)
- also available as a planet version, see page 129

uvex pheos S-KR Mips			
Art. no.	9772090	9772190	9772260
Colour	white	yellow	hi-viz orange
Version	with short brim	with short brim	with short brim
Material	HDPE	HDPE	HDPE
Standard	EN 397	EN 397	EN 397
	-30°C, MM	-30°C, MM	-30°C, MM
Sizes	52 to 61 cm	52 to 61 cm	52 to 61 cm
Order unit	PC	PC	PC
Outer packaging	20 PC per CT	20 PC per CT	20 PC per CT

Safety Helmets

uvex airwing B · uvex airwing B-WR · uvex super boss



uvex airwing B · uvex airwing B-WR

- safety helmet with slots for uvex visors and earmuffs
- side Euroslot adapters (30 mm) for attaching earmuffs
- meets standard EN 397 and additional requirement for very low temperatures (-30 °C)
- three variable air vents for maximum ventilation
- conventional suspension harness for comfortable adjustable fit (uvex airwing B)
- suspension harness with wheel ratchet for variable width adjustment (uvex airwing B-WR)
- fitted with the 9760005 sweatband
- six-point textile band attachment ensures optimal fit and comfort

uvex airwing B with conventional suspension harness							
Art. no.	9762020	9762120	9762220	9762320	9762420	9762520	9762920
Colour	white	yellow	orange	red	green	blue	black
Version	with long brim	with long brim	with long brim	with long brim	with long brim	with long brim	with long brim
Material	HDPE	HDPE	HDPE	HDPE	HDPE	HDPE	HDPE
Standard	EN 397, -30 °C	EN 397, -30 °C	EN 397, -30 °C	EN 397, -30 °C	EN 397, -30 °C	EN 397, -30 °C	EN 397, -30 °C
Sizes	51 to 61 cm	51 to 61 cm	51 to 61 cm	51 to 61 cm	51 to 61 cm	51 to 61 cm	51 to 61 cm
Order unit	PC	PC	PC	PC	PC	PC	PC
Outer packaging	25 PC per CT	25 PC per CT	25 PC per CT	25 PC per CT	25 PC per CT	25 PC per CT	25 PC per CT

uvex airwing B-WR with wheel ratchet system						
Art. no.	9762030	9762130	9762230	9762330	9762430	9762530
Colour	white	yellow	orange	red	green	blue
Version	with long brim	with long brim	with long brim	with long brim	with long brim	with long brim
Material	HDPE	HDPE	HDPE	HDPE	HDPE	HDPE
Standard	EN 397, -30 °C	EN 397, -30 °C	EN 397, -30 °C	EN 397, -30 °C	EN 397, -30 °C	EN 397, -30 °C
Sizes	52 to 61 cm	52 to 61 cm	52 to 61 cm	52 to 61 cm	52 to 61 cm	52 to 61 cm
Order unit	PC	PC	PC	PC	PC	PC
Outer packaging	25 PC per CT	25 PC per CT	25 PC per CT	25 PC per CT	25 PC per CT	25 PC per CT



uvex super boss

- safety helmet with slots for uvex visors and earmuffs
- side Euroslot adapters (30 mm) for attaching earmuffs
- meets standard EN 397 and additional requirement for very low temperatures (-20 °C)
- conventional suspension harness for comfortable adjustable fit
- fitted with the 9790004 sweatband
- adjustable side ventilation slits
- six-point textile band attachment ensures optimal fit and comfort

uvex super boss with conventional suspension harness			
Art. no.	9750020	9750120	9750520
Colour	white	yellow	blue
Version	with long brim	with long brim	with long brim
Material	HDPE	HDPE	HDPE
Standard	EN 397, -20 °C	EN 397, -20 °C	EN 397, -20 °C
Sizes	52 to 61 cm	52 to 61 cm	52 to 61 cm
Order unit	PC	PC	PC
Outer packaging	25 PC per CT	25 PC per CT	25 PC per CT

Safety Helmets

uvex airwing B-S · uvex airwing B-S-WR · uvex thermo boss



uvex airwing B-S · uvex airwing B-S-WR

- safety helmet with slots for uvex visors and earmuffs
- side Euroslot adapters (30 mm) for attaching earmuffs
- meets standard EN 397 and additional requirement for very low temperatures (-30 °C)
- three variable air vents for maximum ventilation
- conventional suspension harness for comfortable adjustable fit (uvex airwing B-S)

- suspension harness with wheel ratchet for variable width adjustment (uvex airwing B-S-WR)
- fitted with the 9760005 sweatband
- shorter brim for a wider field of upward vision
- six-point textile band attachment ensures optimal fit and comfort

uvex airwing B-S with conventional suspension harness

Art. no.	9762021	9762121	9762221	9762321	9762421	9762521
Colour	white	yellow	orange	red	green	blue
Version	with short brim	with short brim	with short brim	with short brim	with short brim	with short brim
Material	HDPE	HDPE	HDPE	HDPE	HDPE	HDPE
Standard	EN 397, -30 °C	EN 397, -30 °C	EN 397, -30 °C	EN 397, -30 °C	EN 397, -30 °C	EN 397, -30 °C
Sizes	51 to 61 cm	51 to 61 cm	51 to 61 cm	51 to 61 cm	51 to 61 cm	51 to 61 cm
Order unit	PC	PC	PC	PC	PC	PC
Outer packaging	25 PC per CT	25 PC per CT	25 PC per CT	25 PC per CT	25 PC per CT	25 PC per CT

uvex airwing B-S-WR with wheel ratchet system

Art. no.	9762031	9762131	9762231	9762331	9762431	9762531
Colour	white	yellow	orange	red	green	blue
Version	with short brim	with short brim	with short brim	with short brim	with short brim	with short brim
Material	HDPE	HDPE	HDPE	HDPE	HDPE	HDPE
Standard	EN 397, -30 °C	EN 397, -30 °C	EN 397, -30 °C	EN 397, -30 °C	EN 397, -30 °C	EN 397, -30 °C
Sizes	52 to 61 cm	52 to 61 cm	52 to 61 cm	52 to 61 cm	52 to 61 cm	52 to 61 cm
Order unit	PC	PC	PC	PC	PC	PC
Outer packaging	25 PC per CT	25 PC per CT	25 PC per CT	25 PC per CT	25 PC per CT	25 PC per CT



uvex thermo boss

- safety helmet with slots for uvex visors and earmuffs
- the helmet shell is made from heat-resistant polycarbonate and is suitable for use in high ambient temperatures.
- side Euroslot adapters (30 mm) for attaching earmuffs
- meets standard EN 397 and additional requirement (440 V AC) +150 °C
- conventional suspension harness for comfortable adjustable fit
- fitted with the 9790004 sweatband
- six-point textile band attachment ensures optimal fit and comfort

uvex thermo boss

Art. no.	9754000	9754100	9754300
Colour	white	yellow	red
Version	with long brim	with long brim	with long brim
Material	PC reinforced with fibreglass		
Standard	EN 397	EN 397	EN 397
	+150 °C, 440 V AC	+150 °C, 440 V AC	+150 °C, 440 V AC
Sizes	52 to 61 cm	52 to 61 cm	52 to 61 cm
Order unit	PC	PC	PC
Outer packaging	25 PC per CT	25 PC per CT	25 PC per CT

MADE IN GERMANY



Safety Helmets

uvex pheos alpine



uvex pheos alpine

- multifunctional helmet for working at heights and rescue operations
- combines the features of an industrial protection helmet (EN 397) with the requirements for a climbing helmet (EN 12492)
- light ABS helmet shell offers a high level of protection and durability
- shorter brim for a wider field of upward vision
- side Euroslot adapters (30 mm) for attaching earmuffs and visor
- options for attaching head torches and goggles
- permanently opened air vents
- meets standard EN 397 and additional requirements for very low temperatures (-30°C)
- firmly riveted chin strap for use in accordance with EN 12492

- six-point textile band attachment ensures ideal fit and great comfort
- suspension harness with wheel ratchet system for variable width adjustment
- the helmet is delivered as standard with a black PU sweatband (art. no. 9760009); there is also an option of a light sweatband made of synthetic leather (art. no. 9760005)



product design award

2013

uvex pheos alpine with wheel ratchet system

Art. no.	9773050	9773150	9773250	9773350	9773450	9773550	9773950
Colour	white	yellow	orange	red	green	blue	black
Version	with short brim	with short brim	with short brim	with short brim	with short brim	with short brim	with short brim
Material	ABS	ABS	ABS	ABS	ABS	ABS	ABS
Standard	EN 397, -30 °C EN 12492	EN 397, -30 °C EN 12492	EN 397, -30 °C EN 12492	EN 397, -30 °C EN 12492	EN 397, -30 °C EN 12492	EN 397, -30 °C EN 12492	EN 397, -30 °C EN 12492
Sizes	52 to 61 cm	52 to 61 cm	52 to 61 cm	52 to 61 cm	52 to 61 cm	52 to 61 cm	52 to 61 cm
Order unit	PC,	PC,	PC,	PC,	PC,	PC,	PC,
Outer packaging	individually packed in CT 6 PC per CT	individually packed in CT 6 PC per CT	individually packed in CT 6 PC per CT	individually packed in CT 6 PC per CT	individually packed in CT 6 PC per CT	individually packed in CT 6 PC per CT	individually packed in CT 6 PC per CT

LD-tested



uvex perffxion

- unique combination of the standards EN 397 (meets partly), EN 12492 and EN 1078
- side Euroslot adapters (30 mm) for attaching earmuffs
- additional slots allow for a wide variety of accessories to be attached
- complies with the following standards:
 - EN 397 (in part) – Industrial safety helmet standard
 - optional requirements: LD, -30°C
 - EN 12492 – Mountaineering helmet standard
 - EN 1078 – Cycling helmet standard

- increased resistance to lateral deformation (LD) provides additional protection
- adjustable and convenient air vents for maximum ventilation
- suspension harness with wheel ratchet system for variable width adjustment and height adjustment
- suspension harness with convenient inner mesh for added wearer comfort
- optimal fit thanks to two different sizes (M and L)
- additional clip-on brim included in the scope of delivery

uvex perffxion

Art. no.	9720940	9720950	9720040	9720050
Colour	black	black	white	white
Version	with short brim	with short brim	with short brim	with short brim
Material	ABS	ABS	ABS	ABS
Standard	EN 397, -30 °C, LD EN 12492, EN 1078	EN 397, -30 °C, LD EN 12492, EN 1078	EN 397, -30 °C, LD EN 12492, EN 1078	EN 397, -30 °C, LD EN 12492, EN 1078
Sizes	M (52 to 58 cm)	L (59 to 63 cm)	M (52 to 58 cm)	L (59 to 63 cm)
Order unit	PC	PC	PC	PC
Outer packaging	6 PC per CT	6 PC per CT	6 PC per CT	6 PC per CT

Safety Helmets

uvex pheos forestry · uvex pheos ABS



Further information can be found at uvex-safety.com/en/forestryset (or scan the QR code).



9774236



9774237



9774238



uvex pheos forestry

- set specially developed to meet the needs of forestry workers, consisting of the uvex pheos ABS B-S-WR, uvex pheos forestry visor and uvex pheos K2P mechanical
- labelled with label set, including pre-attached chin strap and signal whistle
- meets standards EN 166, 1731, 352-1 and 397 and additional requirement for very low temperatures (-30 °C)
- fully integrated metal mesh visor with high transmission (transparency) protects against foreign objects and ensures a clear view
- high-insulation earmuffs (SNR: 30 dB) round off the system perfectly and reliably protect against noise produced by chainsaws and brush cutters
- three variable air vents for maximum ventilation, offering ventilation in the direction of movement
- suspension harness with wheel ratchet system enables the width to be variably adjusted with just one hand

uvex pheos forestry - pre-assembled set			
Art. no.	9774236	9774237	9774238
Colour	yellow	orange	red
Version	with short brim	with short brim	with short brim
Material	ABS	ABS	ABS
Standard	EN 397, -30 °C, MM	EN 397, -30 °C, MM	EN 397, -30 °C, MM
	EN 1731:2006-F	EN 1731:2006-F	EN 1731:2006-F
	EN 352-3	EN 352-3	EN 352-3
Sizes	52 to 61 cm	52 to 61 cm	52 to 61 cm
Order unit	PC	PC	PC
Outer packaging	15 PC per CT	15 PC per CT	15 PC per CT

uvex pheos forestry - spare parts		
Art. no.		Order unit
9790210	Replacement visor (metal)	PC
2600214	uvex K2P mechanical	PR
9760106	Replacement suspension harness pheos ABS	PC
9760009	Sweatband pheos ABS	PC
9790021	Four-point chin strap	PC
9790146	Signal whistle	PC



9772071



9772171



9772271



9772371

uvex pheos ABS

- ABS safety helmet with slots for uvex visors, earmuffs and helmet lamps
- side Euroslot adapters (30 mm) for attaching earmuffs
- meets EN 397 standards and additional requirements for very low temperatures (-30°C)
- high lateral rigidity
- three variable air vents for maximum ventilation
- conventional suspension harness for comfortable adjustable fit (uvex pheos B)
- suspension harness with wheel ratchet system (9760106) and sweatband (9760009)
- six-point textile band attachment ensures optimum fit and comfort

uvex pheos ABS B-S-WR with wheel ratchet system				
Art. no.	9772071	9772171	9772271	9772371
Colour	white	yellow	orange	red
Version	with short brim	with short brim	with short brim	with short brim
Material	ABS	ABS	ABS	ABS
Standard	EN 397	EN 397	EN 397	EN 397
	-30 °C, MM	-30 °C, MM	-30 °C, MM	-30 °C, MM
Sizes	52 to 61 cm	52 to 61 cm	52 to 61 cm	52 to 61 cm
Order unit	PC	PC	PC	PC
Outer packaging	24 PC per CT	24 PC per CT	24 PC per CT	24 PC per CT

MADE IN GERMANY



Safety Helmets

uvex pheos E · uvex pheos E-WR · uvex pheos E-S-WR



uvex pheos B · uvex pheos B-WR

- safety helmet with slots for uvex visors, earmuffs and lamps
- side Euroslot adapters (30 mm) for attaching earmuffs
- meets standard EN 397 and additional requirements for very low temperatures (-30 °C) and molten metal (MM) splash
- three variable air vents for maximum ventilation
- conventional suspension harness for comfortable adjustable fit (uvex pheos B)
- suspension harness with wheel ratchet for variable width adjustment (uvex pheos B-WR)
- fitted with the 9760005 sweatband
- six-point textile band attachment ensures optimal fit and comfort

uvex pheos B with conventional suspension harness						
Art. no.	9772020	9772120	9772220	9772320	9772520	9772920
Colour	white	yellow	orange	red	blue	black
Version	with long brim					
Material	HDPE	HDPE	HDPE	HDPE	HDPE	HDPE
Standard	EN 397	EN 397	EN 397	EN 397	EN 397	EN 397
	-30 °C, MM	-30 °C, MM	-30 °C, MM	-30 °C, MM	-30 °C, MM	-30 °C, MM
Sizes	51 to 61 cm	51 to 61 cm	51 to 61 cm	51 to 61 cm	51 to 61 cm	51 to 61 cm
Order unit	PC	PC	PC	PC	PC	PC
Outer packaging	25 PC per CT	25 PC per CT	25 PC per CT	25 PC per CT	25 PC per CT	25 PC per CT

uvex pheos B-WR with wheel ratchet system							
Art. no.	9772030	9772130	9772230	9772330	9772430	9772530	9772930
Colour	white	yellow	orange	red	green	blue	black
Version	with long brim	with long brim	with long brim	with long brim	with long brim	with long brim	with long brim
Material	HDPE	HDPE	HDPE	HDPE	HDPE	HDPE	HDPE
Standard	EN 397	EN 397	EN 397	EN 397	EN 397	EN 397	EN 397
	-30 °C, MM	-30 °C, MM	-30 °C, MM	-30 °C, MM	-30 °C, MM	-30 °C, MM	-30 °C, MM
Sizes	52 to 61 cm	52 to 61 cm	52 to 61 cm	52 to 61 cm	52 to 61 cm	52 to 61 cm	52 to 61 cm
Order unit	PC	PC	PC	PC	PC	PC	PC
Outer packaging	25 PC per CT	25 PC per CT	25 PC per CT	25 PC per CT	25 PC per CT	25 PC per CT	25 PC per CT



uvex pheos B-S-WR

- safety helmet with slots for uvex visors, earmuffs and lamps
- side Euroslot adapters (30 mm) for attaching earmuffs
- meets standard EN 397 and additional requirements for very low temperatures (-30 °C) and molten metal (MM) splash
- three variable air vents for maximum ventilation
- suspension harness with wheel ratchet for variable width adjustment

- fitted with the 9760005 sweatband
- shorter brim for a wider field of upward vision
- six-point textile band attachment ensures optimal fit and comfort

uvex pheos B-S-WR with wheel ratchet system							
Art. no.	9772031	9772131	9772231	9772332	9772531	9772832	9772932
Colour	white	yellow	orange	red	blue	dark grey	black
Version	with short brim	with short brim	with short brim	with short brim	with short brim	with short brim	with short brim
Material	HDPE	HDPE	HDPE	HDPE	HDPE	HDPE	HDPE
Standard	EN 397	EN 397	EN 397	EN 397	EN 397	EN 397	EN 397
	-30 °C, MM	-30 °C, MM	-30 °C, MM	-30 °C, MM	-30 °C, MM	-30 °C, MM	-30 °C, MM
Sizes	52 to 61 cm	52 to 61 cm	52 to 61 cm	52 to 61 cm	52 to 61 cm	52 to 61 cm	52 to 61 cm
Order unit	PC	PC	PC	PC	PC	PC	PC
Outer packaging	25 PC per CT	25 PC per CT	25 PC per CT	25 PC per CT	25 PC per CT	25 PC per CT	25 PC per CT



protecting planet

To help raise awareness of its commitment to achieving increased sustainability, uvex has developed the **protecting planet** icon.

For uvex, **protecting planet** is more than a label. Based on the brand claim, **protecting people**, our sustainable approach integrates three core interlinked pillars – **ecology, economy** and **social responsibility**, that are incorporated throughout the business to improve our sustainability performance.

This explains the comprehensive audit, measurement and evaluation management process uvex undertakes along the entire value chain to ensure its products are as sustainable as possible.



Creation date 05/2022



9772042

The **uvex pheos planet** is an example of the **planet series** product system.

protecting planet
by using recycled material //
by using bio-based material

The helmet shell is made of up to 30 percent bioplastic. The organic raw material, sugar cane, is converted using a process that complies with the strictest quality requirements and achieves high stability and strength. 50 percent of the material for the headband is made of helmet shells. This significantly reduces process-related waste during production.

protecting planet
by using environmentally-
friendly packaging

All individual packaging is made of regranulated material and has been taken from the recycling economy. The packaging is single-grade and can be returned to the recycling chain after use. This also saves fossil resources. The user instructions are printed on 100 percent recycled paper.

uvex pheos planet B-WR · pheos planet B-S-WR · pheos planet S-KR Mips

- safety helmet with slots for uvex visors, helmet earmuffs and helmet torches
- helmet shell partially made of bio-based plastic
- head rings made of regranulated helmet shells
- MIPS inner shell absorbs rotational forces on the uvex pheos planet S-KR MIPS
- three adjustable air vents for maximum ventilation
- suspension harness with wheel ratchet system for variable width adjustment
- six-point textile band attachment ensures excellent fit and comfort
- pre-assembled four-point forked chin strap (9790021) for uvex pheos planet S-KR MIPS
- large neck piece (9790149) increases the wearer comfort of the uvex pheos planet S-KR MIPS
- equipped with sweatband 9760005 or 9760260 in the case of uvex pheos planet S-KR MIPS

	uvex pheos planet B-WR	uvex pheos planet B-S-WR	uvex pheos planet S-KR Mips
Art. no.	9772042	9772043	9772092
Colour	white	white	white
Version	with long brim	with short brim	with short brim and Mips-Technology
Material	HDPE	HDPE	HDPE
Standard	EN 397	EN 397	EN 397
	-30 °C, MM	-30 °C, MM	-30°C, MM
Sizes	52 to 61 cm	52 to 61 cm	52 to 61cm
Order unit	PC	PC	PC
Outer packaging	25 PC per CT	25 PC per CT	25 PC per CT

Safety Helmets

uvex pheos E · uvex pheos E-WR · uvex pheos E-S-WR



uvex pheos E · uvex pheos E-WR

- safety helmet with slots for uvex visors, earmuffs and lamps
- side Euroslot adapters (30 mm) for attaching earmuffs
- suitable for use by electricians as helmet shell is fully enclosed
- meets standard EN 397 and additional requirements for very low temperatures (-30 °C) and molten metal (MM) splash and is approved in accordance with EN 50365 (1000 V AC)
- conventional suspension harness for comfortable adjustable fit (uvex pheos E)
- suspension harness with wheel ratchet for variable width adjustment (uvex pheos E-WR)
- fitted with the 9760005 (uvex pheos E) or 9760009 (uvex pheos E-WR) sweatband
- six-point textile band attachment ensures optimal fit and comfort

uvex pheos E with conventional suspension harness		
Art. no.	9770020	9770120
Colour	white	yellow
Version	with long brim	with long brim
Material	HDPE	HDPE
Standard	EN 397	EN 397
	-30 °C, MM	-30 °C, MM
	EN 50365, 1000 V AC	EN 50365, 1000 V AC
Sizes	51 to 61 cm	51 to 61 cm
Order unit	PC	PC
Outer packaging	25 PC per CT	25 PC per CT

uvex pheos E-WR with wheel ratchet system							
Art. no.	9770030	9770130	9770230	9770330	9770430	9770530	9770830
Colour	white	yellow	orange	red	green	blue	dark grey
Version	with long brim	with long brim	with long brim	with long brim	with long brim	with long brim	with long brim
Material	HDPE	HDPE	HDPE	HDPE	HDPE	HDPE	HDPE
Standard	EN 397	EN 397	EN 397	EN 397	EN 397	EN 397	EN 397
	-30 °C, MM	-30 °C, MM	-30 °C, MM	-30 °C, MM	-30 °C, MM	-30 °C, MM	-30 °C, MM
	EN 50365, 1000 V AC	EN 50365, 1000 V AC	EN 50365, 1000 V AC	EN 50365, 1000 V AC	EN 50365, 1000 V AC	EN 50365, 1000 V AC	EN 50365, 1000 V AC
Sizes	52 to 61 cm	52 to 61 cm	52 to 61 cm	52 to 61 cm	52 to 61 cm	52 to 61 cm	52 to 61 cm
Order unit	PC	PC	PC	PC	PC	PC	PC
Outer packaging	25 PC per CT	25 PC per CT	25 PC per CT	25 PC per CT	25 PC per CT	25 PC per CT	25 PC per CT



uvex pheos E-S-WR

- safety helmet with slots for uvex visors, earmuffs and lamps
- side Euroslot adapters (30 mm) for attaching earmuffs
- suitable for use by electricians as helmet shell is fully enclosed
- meets standard EN 397 and additional requirements for very low temperatures (-30 °C) and molten metal (MM) splash and is approved in accordance with EN 50365 (1000 V AC)
- suspension harness with wheel ratchet for variable width adjustment
- fitted with the 9760009 sweatband
- shorter brim for a wider field of upward vision
- six-point textile band attachment ensures optimal fit and comfort

uvex pheos E-S-WR with wheel ratchet system								
Art. no.	9770031	9770131	9770231	9770331	9770431	9770531	9770832	9770931
Colour	white	yellow	orange	red	green	blue	dark grey	black
Version	with short brim	with short brim	with short brim	with short brim	with short brim	with short brim	with short brim	with short brim
Material	HDPE	HDPE	HDPE	HDPE	HDPE	HDPE	HDPE	HDPE
Standard	EN 397	EN 397	EN 397	EN 397	EN 397	EN 397	EN 397	EN 397
	-30 °C, MM	-30 °C, MM	-30 °C, MM	-30 °C, MM	-30 °C, MM	-30 °C, MM	-30 °C, MM	-30 °C, MM
	EN 50365	EN 50365	EN 50365	EN 50365	EN 50365	EN 50365	EN 50365	EN 50365
	1000 V AC	1000 V AC	1000 V AC	1000 V AC	1000 V AC	1000 V AC	1000 V AC	1000 V AC
Sizes	52 to 61 cm	52 to 61 cm	52 to 61 cm	52 to 61 cm	52 to 61 cm	52 to 61 cm	52 to 61 cm	52 to 61 cm
Order unit	PC	PC	PC	PC	PC	PC	PC	PC
Outer packaging	25 PC per CT	25 PC per CT	25 PC per CT	25 PC per CT	25 PC per CT	25 PC per CT	25 PC per CT	25 PC per CT





uvex

Safety Helmets

uvex pheos IES · uvex pheos S-KR · reflex set



uvex pheos IES

- safety helmet with slots for uvex visors, earmuffs, lamps and Integrated Eyewear System (IES)
- side Euroslot adapters (30 mm) for attaching earmuffs
- meets standard EN 397 and additional requirements for very low temperatures (-30 °C) and molten metal (MM) splash
- three variable air vents for maximum ventilation
- suspension harness with wheel ratchet for variable width adjustment – also has the option to mount uvex pheos, uvex pheos or uvex i-works safety spectacles
- fitted with the 9760007 sweatband
- six-point textile band attachment ensures optimal fit and comfort

uvex pheos IES with wheel ratchet system					
Art. no.	9772040	9772140	9772240	9772340	9772540
Colour	white	yellow	orange	red	blue
Version	with long brim				
Material	HDPE	HDPE	HDPE	HDPE	HDPE
Standard	EN 397	EN 397	EN 397	EN 397	EN 397
	-30 °C, MM	-30 °C, MM	-30 °C, MM	-30 °C, MM	-30 °C, MM
Sizes	55 to 61 cm	55 to 61 cm	55 to 61 cm	55 to 61 cm	55 to 61 cm
Order unit	PC	PC	PC	PC	PC
Outer packaging	25 PC per CT	25 PC per CT	25 PC per CT	25 PC per CT	25 PC per CT

MADE IN GERMANY



uvex pheos S-KR

- safety helmet with slots for uvex visors, helmet earmuffs and helmet torches
- side Euroslot adapters (30 mm) for attaching earmuffs
- three adjustable air vents for maximum ventilation
- fitted with the sweatband 9760005
- suspension harness with wheel ratchet system for variable width adjustment
- six-point textile band attachment ensures excellent fit and comfort
- pre-fitted four-point forked chin strap
- attachment clip (9790022) for positioning the forked chin strap in the resting position or as a holder for goggles
- products that are eligible according to BG-Bau (German employer's liability insurance association for the construction industry) are available on request

uvex pheos S-KR					
Art. no.	9772034	9772134	9772234	9772335	9772534
Colour	white	yellow	orange	red	blue
Version	with short brim				
Material	HDPE	HDPE	HDPE	HDPE	HDPE
Standard	EN 397	EN 397	EN 397	EN 397	EN 397
	-30 °C, MM	-30 °C, MM	-30 °C, MM	-30 °C, MM	-30 °C, MM
Sizes	52 to 61 cm	52 to 61 cm	52 to 61 cm	52 to 61 cm	52 to 61 cm
Order unit	PC	PC	PC	PC	PC
Outer packaging	25 PC per CT	25 PC per CT	25 PC per CT	25 PC per CT	25 PC per CT

MADE IN GERMANY



uvex pheos reflex set L

- safety helmet with highly reflective sticker set
- helmets are delivered with the stickers already applied



uvex pheos reflex set L
(select preferred helmet colour)

uvex pheos reflex set L					
Art. no.	Colour	Version	Art. no.	Colour	Version
9770026	white	uvex pheos E with reflective sticker	9772526	blue	uvex pheos B with reflective sticker
9770126	yellow	uvex pheos E with reflective sticker	9772035	white	uvex pheos B-WR with reflective sticker
9770036	white	uvex pheos E-WR with reflective sticker	9772138	yellow	uvex pheos B-WR with reflective sticker
9770136	yellow	uvex pheos E-WR with reflective sticker	9772236	orange	uvex pheos B-WR with reflective sticker
9770536	blue	uvex pheos E-WR with reflective sticker	9772437	green	uvex pheos B-WR with reflective sticker
9772045	white	uvex pheos IES with reflective sticker	9772538	blue	uvex pheos B-WR with reflective sticker
9772246	orange	uvex pheos IES with reflective sticker	9772936	black	uvex pheos B-WR with reflective sticker
9772343	red	uvex pheos IES with reflective sticker	9772038	white	uvex pheos B-S-WR with reflective sticker
9772046	white	uvex pheos S-KR with reflective sticker	9772137	yellow	uvex pheos B-S-WR with reflective sticker
9772541	blue	uvex pheos S-KR with reflective sticker	9772334	red	uvex pheos B-S-WR with reflective sticker
9772026	white	uvex pheos B with reflective sticker	9772433	green	uvex pheos B-S-WR with reflective sticker
9772126	yellow	uvex pheos B with reflective sticker	9772537	blue	uvex pheos B-S-WR with reflective sticker
9772226	orange	uvex pheos B with reflective sticker	9772937	black	uvex pheos B-S-WR with reflective sticker
9772326	red	uvex pheos B with reflective sticker			
Order quantity multiples/ Order unit 25 PC					

► Please contact our service hotline on +49 911 9736-0.

Safety Helmets

Accessories



9790065
with safety helmet
(helmet not included)



9790075
with safety helmet
(helmet not included)



9790076
with safety helmet
(helmet not included)



9790068



9790066



9790086
with safety helmet
(helmet not included)



9790086

uvex winter cap

- winter cap for use in all uvex helmets
- windproof and waterproof outer material
- all-around reflective strip
- side mesh to increase the wearer's attention to environmental influences (ear area)
- warming fleece lining

uvex balaclava

- uvex balaclava is the ideal addition to the winter cap – with continuous size adjustment through hinged Velcro fastening

uvex neck protection

- uvex neck protection for protection against rain, dust, splinters and solar radiation
- for use with all uvex helmets
- fitted with mount 9790022 to attach the neck protection in the uvex pheos helmet shell

uvex cooling neck protection

- with unique cooling function – up to 8 hours cooling effect, protection from sunlight

	uvex winter cap		uvex balaclava	uvex neck protection		uvex cooling neck protection
Art. no.	9790065	9790068	9790066	9790075	9790076	9790086
Version	100% polyester	100% polyester	100% polyester	100% polyester	100% polyester	100% polyester
Colour	hi-viz yellow	hi-viz orange	black	orange	yellow	yellow
Sizes	unysize	unysize	unysize	unysize	unysize	unysize
Order unit	PC	PC	PC	PC	PC	PC



9790006



9790010



9790015



9790016



9790012

Hygienic caps · Winter caps

	Hygienic cap	Winter caps			
Art. no.	9790006	9790010	9790015	9790016	9790012
Version	100% fleece	50% cotton 50% wool	50% cotton 50% virgin wool	60% polyester, 30% wool 8% nylon, 2% elastane	60% polyester, 30% wool 8% nylon, 2% elastane
Colour	white	navy blue	black	black	navy blue
Sizes	unysize	unysize	S to M	L to XL	unysize
Order unit	80 PC	PC	PC	PC	PC

Safety Helmets

Accessories



9790000

9790004

Accessories for uvex super boss and uvex thermo boss

	Suspension harness for uvex super boss and uvex thermo boss	Sweatband for uvex super boss and uvex thermo boss
Art. no.	9790000	9790004
Version	Six-point textile attachment with sweatband	Artificial leather (leatherette)
Order unit	PC	10 PC



9772001

9760007

Accessories for uvex pheos IES

	Suspension harness for IES For uvex pheos (Not pheos E and pheos alpine)	Sweatband for pheos IES
Art. no.	9772001	9760007
Version	Six-point textile suspension with textile sweatband with uvex pheos glasses clip	textile/foam material
Order unit	PC	10 PC



9760012

9760011

9760009

9760014

Accessories for uvex pheos E-WR and uvex pheos alpine

	Suspension harness for uvex pheos E-WR	Suspension harness for uvex pheos alpine
Art. no.	9760012	9760011
Version	Six-point textile attachment with sweatband	Six-point textile attachment with sweatband
Order unit	PC	PC
	Sweatband for uvex pheos alpine and uvex pheos E-WR	Wheel ratchet padding
Art. no.	9760009	9760014
Version	PU, leather	polyester
Order unit	10 PC	10 PC

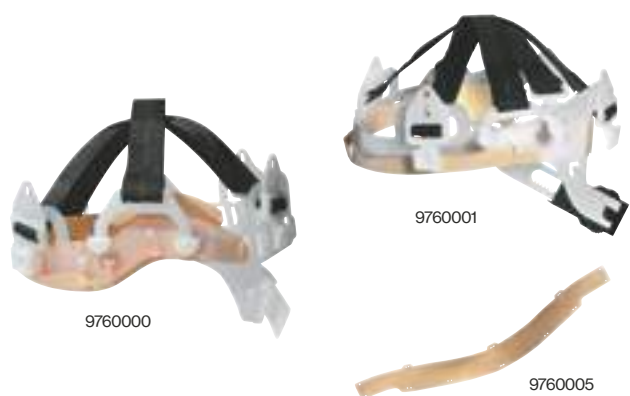

9760000

9760001

9760005

Accessories for uvex pheos and uvex airwing

	Conventional suspension harness for uvex pheos and uvex airwing	Suspension harness for uvex pheos and uvex airwing (not for uvex pheos E) with wheel ratchet
Art. no.	9760000	9760001
Version	Six-point textile attachment with sweatband	Six-point textile attachment with sweatband
Order unit	PC	PC
	Sweatband for uvex pheos, uvex airwing and uvex pheos alpine	
Art. no.	9760005	
Version	Artificial leather (leatherette) with sweatband	
Order unit	10 PC	

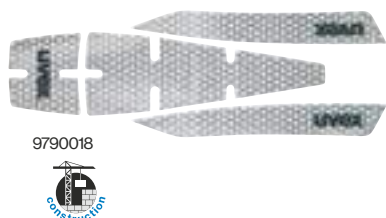

9790018

uvex pheos reflex set M

- highly reflective sticker set
- extremely high brightness with prism film
- easy to affix
- suitable for all uvex pheos and uvex pheos alpine safety helmets

	uvex pheos reflex set M
Art. no.	9790018
Order unit	PC



Safety Helmets

Accessories



Accessories for uvex pheos, uvex pheos alpine, uvex airwing, uvex super boss and uvex thermo boss

	Leather chin straps for uvex pheos (not for pheos IES and pheos E), uvex pheos alpine, uvex airwing, uvex superboss and uvex thermo boss	
Art. no.	9790005	
Version	Robust leather design with plastic eyelets with metal rivets, adjustable length	
Order unit	PC	
	Forked chin straps for uvex airwing	Leather chin strap for uvex pheos (not uvex pheos alpine)
Art. no.	9790007	9790035
Version	textile band with push-button quick-action fastener plastic eyelets and chin pad, length can be adjusted	Robust leather design with plastic eyelets with metal rivets, length can be adjusted
Order unit	PC	PC
	Forked chin straps for uvex pheos and uvex pheos E (not for uvex pheos alpine)	
Art. no.	9790021	
Version	Textile strap with quick-release push-button fastening, plastic hooks and chin pad, adjustable length	
Order unit	PC	
	IES mount with sliding element for uvex pheos IES System	Penholder for uvex pheos and uvex pheos E
Art. no.	9772002	9790023
Version	plastic	plastic
Order unit	PC	PC
	Goggles clip for uvex pheos/ chin strap clip for uvex pheos alpine	
Art. no.	9790022	
Version	Plastic clip for fixing the goggles band or the chin strap on the helmet	
Order unit	PC	
	uvex spiderneck neck support	
Art. no.	9790149	
Version	Kunststoffclip zur Fixierung des Vollsichtbrillenbandes bzw. des Kinnriemens am Helm for use with the uvex pheos alpine increases neck support, improves comfort, improved weight distribution across the helmet easy installation: is threaded over the wheel ratchet	
Order unit	PC	
	Business card holder	
Art. no.	9790166	
Content	10 holders + 20 PVC cards	
Order quantity multiples	10 PC	
	uvex helmet bag for storing and transporting the uvex safety helmet	Helmet slot sealing plug set
Art. no.	9790071	9790077
Version	polyester	plastic
Order unit	PC	PC

uvex pheos helmet sticker

- ideal for identifying different trades
- durable and weather-resistant high-performance PVC film

uvex pheos helmet sticker							
Art. no.	9790150	9790151	9790152	9790153	9790154	9790155	9790156
Colour	silver	yellow	orange	red	green	blue	black
Material	PVC film	PVC film	PVC film	PVC film	PVC film	PVC film	PVC film
Order unit	PC	PC	PC	PC	PC	PC	PC

Safety Helmets

Accessories: Head torches

► All torches fit in the front slot of our uvex helmets.

9790062
9790063



uvex head torch pheos Lights · pheos Lights EX

- LED helmet torch with two separate reflectors for distance and area lighting
- compact design, very low weight (80 g), extremely robust
- power source: 1.7 Ah-Li-Ion battery
- illuminance: max. 6500 lux
- operating temperature: -20 °C to + 60 °C
- charge adapter and micro-USB charger included
- protection class IP 67 (dust-tight and waterproof)
- 9790063: ATEX certification II 2G Ex ib IIC T4

Press switch	Modes	Lumen	Range	Light duration
Area light	low	55	5 m	11 h
	high	115	10 m	5.5 h
Distance light	low	55	50 m	11 h
	high	115	100 m	5.5 h

	LED head torch pheos Lights	LED head torch pheos Lights EX
Art. no.	9790062	9790063
Version	for uvex pheos helmets	for uvex pheos helmets – ATEX
Order unit	PC	PC

9790029



KS-6003-DUO

- LED helmet torch with two separate precision lenses for distance and area lighting
- boost mode (420 lumen) by pressing and holding the button for 5 seconds
- compact design
- Beam can be infinitely adjusted to suit the area to be lit
- power source: lithium-Ion battery, 3.7 V, 1.7 Ah
- operating temperature: -20°C to +60°C
- protection class: IP 68 (dust-tight and waterproof)
- charger included
- charging time: approx. 3 hours

Press switch	Modes	Lumen	Range	Light duration
Area light	normal	70	5 m	10 h
	strong	260	10 m	2.5 h
Distance light	normal	130	100 m	10 h
	strong	260	200 m	2.5 h

	LED head torch KS-6003-DUO
Art. no.	9790029
Version	for uvex pheos helmets
Order unit	PC

9790069



9790064



LED head torch u-cap sport · uvex pheos helmet adapter

- LED head torch with two separate reflectors for distance and area lighting
- sturdy design, with very low weight (55 g without batteries)
- power source: 3 x AAA batteries (not included)
- illuminance: approx. 4000 lux
- operating temperature: -20 °C to +45 °C
- protection class IP 66 (complete protection against dust and powerful water jets)
- Adapter for the LED head torch u-cap sport for combining with the uvex pheos and uvex pheos alpine helmets

Press switch for 1 s	Modes	Lumen	Range	Light duration
Area light	high	30	7 m	80 h
	low	10	3 m	150 h
	medium	40	80 m	70 h
Distance light	high	100	110 m	30 h
	low	5	10 m	150 h

	LED head torch uvex u-cap sport	uvex pheos helmet adapter
Art. no.	9790064	9790069
Version	for uvex u-cap sport	for LED head torch uvex u-cap sport for combining with the uvex pheos and uvex pheos alpine helmets
Order unit	PC	PC

9790028



KS-7630-MCII

- compact design
- protection class IP 67 (dust-tight and waterproof)
- operating temperature -15 °C to 50 °C
- power source: lithium-ion battery
- charging time: approx. 9 hours
- >80% capacity after 500 charging cycles
- ATEX approval (Directive 2014/34/EU)

Mode	Lumen	Strength**	Range	Light duration
Emergency light	70 lm	≥ 3000 lx	80 m	≥ 30 h
Work light	180 lm	≥ 5500 lx	140 m	≥ 14 h
Strong light*	230 lm	≥ 10000 lx	190 m	≥ 6 h

	KS-7630-MCII
Art. no.	9790028
Version	for uvex pheos helmets
Order unit	PC



Accessories

uvex pronamic · uvex perffexion



		uvex pronamic B-WJR	uvex pronamic B-S-WJR	uvex pronamic S-KR	uvex pronamic alpine	uvex pronamic alpine Mlips	uvex pronamic alpine E	uvex pronamic alpine E Mlips	uvex perffexion
9790310	Suspension harness for pronamic	■	■	■	-	-	-	-	-
9790311	Sweatband for pronamic	■	■	■	-	-	-	-	-
9790350	Hygiene kit for pronamic alpine	-	-	-	■	-	■	-	-
9790352	MIPS hygiene kit for pronamic alpine	-	-	-	-	■	-	■	-
9790109	Hygiene kit for perffexion	-	-	-	-	-	-	-	■
9790021	Forked chin strap	■	■	■	■	■	■	■	-
9790351	Forked chin strap EN 12492 for pronamic alpine	-	-	-	■	■	■	■	-
9790035	Leather chin strap IES	■	■	■	■	■	■	■	-
9772002	IES spectacle clip	■	■	■	-	-	-	-	-
9790022	Goggle clip	■	■	■	■	■	■	■	-
9790065	Winter cap, yellow	■	■	■	-	-	-	-	-
9790068	Winter cap, orange	■	■	■	-	-	-	-	-
9790066	Balaclava	■	■	■	■	■	■	■	■
9790075	Neck protection, orange	■	■	■	-	-	-	-	-
9790076	Neck protection, yellow	■	■	■	-	-	-	-	-
9790086	Cooling neck protection	■	■	■	-	-	-	-	-
9790166	Business card holder	■	■	■	■	■	■	■	■
2600201	Earmuffs K1H/K2H	■	■	■	■	■	■	■	■
2600202									
2630210	Earmuffs K10H/K20H/K30H	■	■	■	■	■	■	■	■
2630220									
2630230									
2600214	Earmuffs K1P/K2P bayonet (in combination with 2600236 or pronamic visor)	■	■	■	■	■	■	■	-
2600216									
2600236	uvex pronamic helmet adapter pull bayonet	■	■	■	■	■	■	■	-
9916000	uvex pronamic visor clear sv exc	■	■	■	■	■	-	-	-
9916001	uvex pronamic visor with chin guard	■	■	■	■	■	-	-	-
9916002	uvex pronamic visor clear sv exc. SLB 1	-	-	-	-	-	■	■	-
9916003	uvex pronamic visor sv exc. SLB 2	-	-	-	-	-	■	■	-
9916100	uvex pronamic mesh visor	■	■	■	■	■	-	-	-
9916200	uvex pronamic half visor clear	-	■	■	■	■	-	-	-
9916201	uvex pronamic half visor grey	-	■	■	■	■	-	-	-
9920001	uvex vimox visor	■	■	■	■	■	-	-	-
9790062	LED head torch pheos Lights	■	■	■	■	■	■	■	■
9790063	LED head torch pheos Lights EX	■	■	■	■	■	■	■	■
9790028	KS 7630 MC II	■	■	■	■	■	■	■	■
9790029	LED head torch KS-6003 Duo	■	■	■	■	■	■	■	■
9790064	LED head torch for u-cap sport	■	■	■	■	■	■	■	■
9790069	uvex pheos helmet adapter for u-cap LED	■	■	■	■	■	■	■	■

■ supplied as standard ■ compatible - not compatible

Accessories

uvex pheos



	uvex pheos B	uvex pheos B-WPR	uvex pheos B-S-WPR	uvex pheos E	uvex pheos E-WPR	uvex pheos E-S-WPR	uvex pheos IES	uvex pheos S-KR	uvex pheos S-KR Miips	uvex pheos alpine
9760000	Conventional suspension harness	■	■	■	■	■	■	■	■	-
9760001	Suspension harness with rotating size adjusters	■	■	■	-	-	■	■	■	-
9760011	Suspension harness for pheos alpine	-	-	-	-	-	-	-	-	■
9760012	Suspension harness for uvex pheos E-WR	■	■	■	■	■	■	■	■	-
9772001	Suspension harness IES	■	■	■	-	-	■	■	■	-
9760009	Sweatband uvex pheos alpine and uvex pheos E-WR	■	■	■	■	■	■	■	■	■
9760007	Sweatband IES	-	-	-	-	-	■	-	-	-
9760005	Sweatband, synthetic leather	■	■	■	■	■	-	■	-	-
9760260	Sweatband pheos S-KR Miips	-	-	-	-	-	-	-	■	-
9790035	Leather chin straps IES	■	■	■	-	-	■	■	-	-
9790005	Leather chin straps	■	■	■	-	-	-	■	-	■
9790021	Forked chin straps	■	■	■	■	■	■	■	■	-
9790023	Pen holder	■	■	■	■	■	■	■	■	-
9772002	Mount	-	-	-	-	-	■	-	-	-
9790022	Goggles clip, chin strap clip	■	■	■	■	■	■	■	■	■
9790065	Winter cap, hi-viz yellow	■	■	■	■	■	■	■	■	■
9790066	Balaclava	■	■	■	■	■	■	■	■	■
9790068	Winter cap, hi-viz orange	■	■	■	■	■	■	■	■	■
9790075	Neck protection, orange	■	■	■	■	■	■	■	■	■
9790076	Neck protection, yellow	■	■	■	■	■	■	■	■	■
9790086	uvex cooling neck protection	■	■	■	■	■	■	■	■	■
9790166	Business card holder	■	■	■	■	■	■	■	■	■
9790018	uvex pheos reflex set M	■	■	■	■	■	■	■	■	■
9790151-9790156	uvex pheos helmet sticker	■	■	■	■	■	■	■	■	-
9906002	uvex pheos visor	-	-	■	-	-	■	■	■	■
9906003	uvex pheos visor SLB1	-	-	-	-	-	-	-	-	-
9906005	uvex pheos visor SLB2	-	-	-	-	-	-	-	-	-
9906007	uvex pheos visor SLB2	-	-	-	-	-	-	-	-	-
9906008	uvex pheos visor SLB2	-	-	-	-	-	-	-	-	-
2600201	uvex K1H/ uvex K2H	■	■	■	-	-	■	■	■	■
2600202	uvex K10H/ uvex K20H/ uvex K30H	■	■	■	■	■	■	■	■	■
2630210	uvex K10H/ uvex K20H/ uvex K30H	■	■	■	■	■	■	■	■	■
2630220	uvex K10H/ uvex K20H/ uvex K30H	■	■	■	■	■	■	■	■	■
2630230	uvex K10H/ uvex K20H/ uvex K30H	■	■	■	■	■	■	■	■	■
2600214	uvex K1P/ uvex K2P	■	■	■	■	■	■	■	■	■
2600215	uvex K1P/ uvex K2P	■	■	■	■	■	■	■	■	■
2600216	uvex K1P/ uvex K2P	■	■	■	■	■	■	■	■	■
9790078	Helmet adapter magnet	■	■	■	■	■	■	■	■	■
9790062	LED head torch pheos Lights	■	■	■	■	■	■	■	■	■
9790063	LED head torch pheos Lights EX	■	■	■	■	■	■	■	■	■
9790028	LED head torch KS-7630MCII	■	■	■	■	■	■	■	■	■
9790029	LED head torch KS-6003 DUO	■	■	■	■	■	■	■	■	■
9790064	LED head torch u-cap sport	■	■	■	■	■	■	■	■	■
9790069	uvex pheos helmet adapter	■	■	■	■	■	■	■	■	■

■ supplied as standard

■ compatible

- not compatible

Accessories

uvex airwing · uvex super boss · uvex thermo boss



	uvex airwing B	uvex airwing B-WR	uvex airwing B-S	uvex airwing B-S-WR	uvex super boss	uvex thermo boss
9760000	Conventional suspension harness	■	■	■	-	-
9760001	Suspension harness with rotating size adjusters	■	■	■	-	-
9790000	Suspension harness for uvex super boss / uvex thermo boss	-	-	-	-	■
9760005	Sweatband	■	■	■	■	-
9790004	Sweatband for uvex super boss / uvex thermo boss	-	-	-	-	■
9790005	Leather chin straps	■	■	■	■	■
9790007	Forked chin straps	■	■	■	■	■
9790065	Winter cap, yellow	■	■	■	■	■
9790066	Balaclava	■	■	■	■	■
9790068	Winter cap, orange	■	■	■	■	■
9790075	Neck protection, orange	■	■	■	■	■
9790076	Neck protection, yellow	■	■	■	■	■
9790086	uvex cooling neck protection	■	■	■	■	■
9790047	Helmet bracket uvex 9790	■	■	■	■	-
9790048	Visor lens, PC	■	■	■	■	-
2600201 2600202	uvex K1H/ uvex K2H	■	■	■	■	■
2630210 2630220 2630230	uvex K10H/ uvex K20H/ uvex K30H	■	■	■	■	■

■ supplied as standard

■ compatible

- not compatible





Visors and Face Protection

Visor lenses, certification and norms

The right solution for every requirement



Polycarbonate lenses with uvex supravision excellence coating

Polycarbonate has a high mechanical impact strength. Coated lenses are anti-fog on the inside, and scratch- and chemical-resistant on the outside. The anti-fogging properties are permanent even after repeated cleaning. The lenses are especially easy to clean and less susceptible to dirt due to the non-stick nanotechnology.

Cellulose acetate lenses

Face protection visors made of cellulose acetate are ideally suited for protection against chemicals.

Stainless steel mesh

is robust and has excellent stability and long life. Stainless steel mesh visors offer a higher light transmission than nylon mesh visors and are used for more rugged work in agriculture and forestry.

Standards at a glance

EN 166 – Personal eye protection

The European standard EN166 applies to all types of eye protection. EN 166 visors are made of frames and lenses.

Certification according to DIN EN 166

Marking on frame

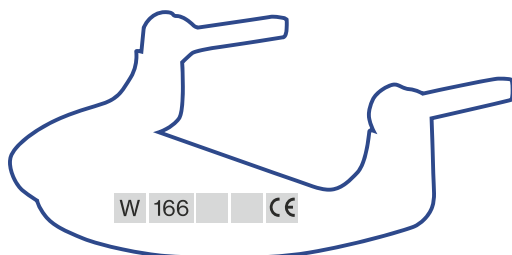

Marking on lenses

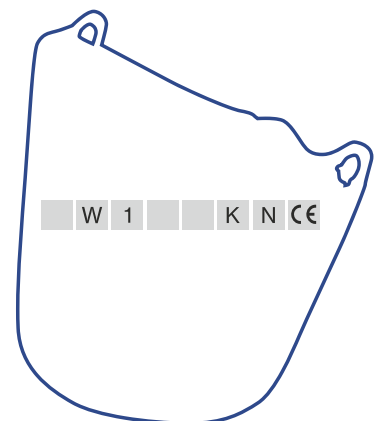

A detailed description of frame and lens markings can be found on page 23.

Labelling and norms

EN 170 – Ultraviolet protection filters

In the standards for special product requirements, the standard EN 170 sets out levels of protection and transmission requirements for ultraviolet protection filters. Excessive exposure to ultraviolet light can cause the lens of the eye to lose its transparency, which may cause

visual impairment or loss of vision. Visor lenses in accordance with EN 170 therefore meet performance requirements to protect the eye from ultraviolet radiation during hazardous work.

EN 1731 – Mesh face protection

The European standard EN 1731 describes all requirements for personal eye and face protection made of mesh material. EN 1731 visors consist of frames and lenses.

Technical information on the frame and the lens are specified according to EN 1731 in the following order:

- Identification of the manufacturer
- Number of European standard
- Symbol for mechanical strength

Mechanical strength	
none	without mechanical strength (filters only)
S	increased strength (filters only)
F	low energy impact (45m/s)
B	medium energy impact (120m/s)
A	high energy impact (190 m/s)
T	tested at extreme temperatures (-5°C and +55°C)



GS-ET 29

When working on energised electrical systems and equipment, the risk of a short circuit electric arc must be assessed. Short circuit electric arcs are usually caused by a short circuit between the electrical lines. The GS-ET 29 test principle is an additional requirement for the testing and certification of electrician face protection. These visors are a category 3 product, which means there is a risk of physical injury and

death. With regards to different intensities of short circuit electric arcs, the certified products must be assessed for their suitability for the respective application. Here, there are distinctions between two classes, Class 1 – up to 4 kA – and Class 2, up to 7 kA.

Certification according to GS-ET 29

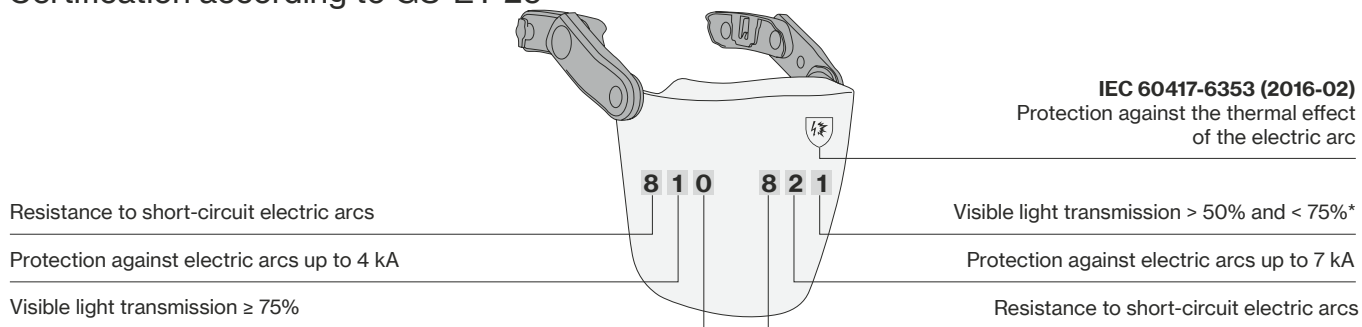

Previously



According to 7 kA short circuit electric arc

*It is obligatory to use an additional illumination, to reach a minimum illuminance of 30 lux behind the faceshield.

Visors and face protection

uvex pronamic visor system

The first sustainable visor system - uvex pronamic. For this visor we rely on a mass-balanced polycarbonate for our visor lens and a recycled plastic made of high-quality post-industrial and post-consumer materials for the visor arms. The result: reduction in CO₂ emissions by over 50% for 100% protection.

Unique uvex click & pull system

The visor can be pulled off the connection system at any time and reattached with a click - perfect for making the helmet a little easier to use when the visor is not needed.

The anti-fog and scratch-resistant visor is made of high-quality, mass-balanced polycarbonate that meets the highest optical quality class. The anti-fogging properties are permanent, even after repeated cleaning. Easy to clean thanks to non-stick nanotechnology. All lenses offer UV 400 protection. The visor fits the helmet seamlessly, leaving no gaps. The injection-moulded transparent peak provides protection against any particles penetrating the inside of the visor.

Suitable for areas of application 3 (liquids) and 9 (molten metal and hot solids). SLB 1 and SLB 2 visors for protection from electrical arcs certified in accordance with GS-ET 29.

Change of lens is possible for an even more sustainable and durable product

uvex earmuffs can be attached to the helmet and removed at any time via a bayonet connection.

The visor can be locked above the helmet shell when not required and the hearing protection can be folded back. Everything fits closely to the helmet and is perfectly balanced over the body's centre of gravity. This means the neck muscles are not placed under strain by any unnecessary weight, ensuring excellent wearer comfort and maximum freedom of movement.

All visors come pre-assembled with a helmet adapter. This is clicked into the side helmet slot and remains attached there. The visor and visor arm can be removed from the helmet at any time.



uvex pronamic

	uvex pronamic	uvex pronamic with chin guard	uvex pronamic SLB 1	uvex pronamic SLB 2	uvex pronamic mesh visor	uvex pronamic adapter pull bayonet
Art. no.	9916000	9916001	9916002	9916003	9916100	2600236
Version	uvex supervision excellence coating	uvex supervision excellence coating	uvex supervision excellence coating	uvex supervision excellence coating	uvex supervision excellence coating	helmet adapter for use on the pronamic full visor and the uvex earmuffs with bayonet connection
	click & pull system for removable visor arms	with small chin guard and click & pull system for removable visor arms	classification short circuit electric arc class 1	classification short circuit electric arc class 2		
	bayonet connection for hearing protection	bayonet connection for hearing protection	click & pull system for removable visor arms	click & pull system for removable visor arms		
			bayonet connection for hearing protection	bayonet connection for hearing protection		
Standard Frame	EN 166, EN 170 black	EN 166, EN 170 black	EN 166, EN 170, GS-ET 29 black	EN 166, EN 170, GS-ET 29 black	EN 1731 black	
	W 166 3 9 8-2 B CE 0196	W 166 3 9 8-2 B CE 0196	W 166 3 9 8-2 B CE 0196	W 166 3 9 8-2 B CE 0196	W EN 1731:2006 F CE	
Lens	PC clear, UV 400	PC clear, UV 400	PC clear, UV 400	PC blue, UV 400	stainless steel mesh	
	2C - 1.2 W 1 B 9 KN CE	2C - 1.2 W 1 B 9 KN CE	2C - 1.2 W 1 B 8-1-0 9 KN CE 0196	2C - 1.2 W 1 B 8-2-0 9 KN CE 0196	W EN 1731:2006 F CE	
Order unit	PC, individually packed in polythene bags	PC, individually packed in polythene bags	PC, individually packed in polythene bags	PC, individually packed in polythene bags	PC, individually packed in polythene bags	BG, packed in pairs in polythene bags
Outer packaging	24 PC per CT	24 PC per CT	24 PC per CT	14 PC per CT	24 PC per CT	
Replacement lens	9906013, individually packed in polythene bags	9906014, individually packed in polythene bags	9906012, individually packed in polythene bags	9906017, individually packed in polythene bags	9790210, individually packed in polythene bags	

Visors and face protection

uvex pronamic visor system

The uvex pronamic half visor completes the pronamic visor family. With two different lens tints, it offers optimum protection and, because of its design, it allows prescription spectacles to be worn at the same time.



If the visor is not needed, it can be locked above the helmet shell, ensuring excellent wearer comfort and maximum freedom of movement.

The polycarbonate half visor has an anti-fog and scratch-resistant coating. Thanks to its design, it offers enough room to wear prescription spectacles as well. The injection-moulded transparent peak fits the helmet seamlessly and provides protection against any particles penetrating the inside of the visor.

Visor is anti-fog on the inside and scratch-resistant on the outside. It also offers UV 400 protection.

Comes pre-assembled with helmet adapter, visor can be removed from the helmet via push button. Suitable for area of application 3

The Euroslot remains free for the use of earmuffs or other accessories.

All visors are pre-assembled with a helmet adapter. This is clicked into the front side helmet slot and remains attached there. The visor can be removed from the helmet at any time thanks to a push button.

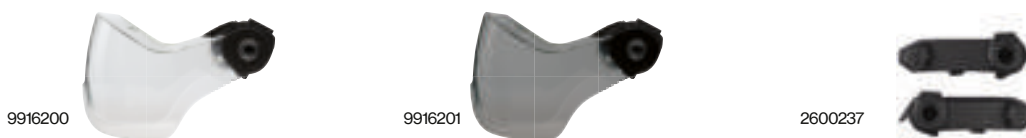

uvex pronamic half visor

Art. no.	uvex pronamic half visor 9916200	uvex pronamic half visor 9916201	uvex pronamic adapter push bayonet 2600237
Version	anti-fog and scratch-resistant coating removable visor via push button	anti-fog and scratch-resistant coating removable visor via push button sun protection	helmet adapter for use with the half visor and the uvex earmuffs with bayonet connection
Standard Frame	EN 166, EN 170 black W 166 3 F CE	EN 166, EN 172 black W 166 3 F CE	
Lens	PC clear, UV 400 2C - 1.2 W 1 F KN CE	PC grey 23%, UV 400 5-2.5 W 1 F KN CE	
Order unit	PC, individually packed in polythene bags	PC, individually packed in polythene bags	BG, packed in pairs in polythene bags
Outer packaging	50 PC per CT	50 PC per CT	

Combination options



	pronamic visor 9916000	pronamic visor with chin guard 9916001	pronamic visor SLB 1 9916002	pronamic visor SLB 2 9916003	pronamic mesh visor 9916100	pronamic half visor clear 9916200	pronamic half visor grey 9916201
uvex pronamic B-WR	■	■	-	-	■	-	-
uvex pronamic B-S-WR	■	■	-	-	■	■	■
uvex pronamic S-KR	■	■	-	-	■	■	■
uvex pronamic alpine	■	■	-	-	■	■	■
uvex pronamic alpine Mips	■	■	-	-	■	-	-
uvex pronamic alpine E	-	-	■	■	-	-	-
uvex pronamic alpine E Mips	-	-	■	■	-	-	-

■ compatible - not compatible

Visors and face protection

uvex vimox visor system

One for all - uvex comfort for a wide variety of helmet models

Don't use a uvex helmet, but still want our unique lens technology? Then uvex vimox is the solution for you. Because we're bringing the most popular features of our visors to (almost) all common helmet models on the market.

Outstanding ergonomics are at the heart of every single product we develop. A comfortable fit should provide the wearer with relief. That's why we integrated a key feature of our pheos visor range into the uvex vimox visor system - the resting position.

If the visor is not actively in use, it can either be removed completely using the uvex click & pull system or alterna-

tively pushed into the resting position - no matter which helmet the vimox is used with. The optimal centre of gravity is located in the middle of the head to support the natural posture of the neck and significantly reduce strain.

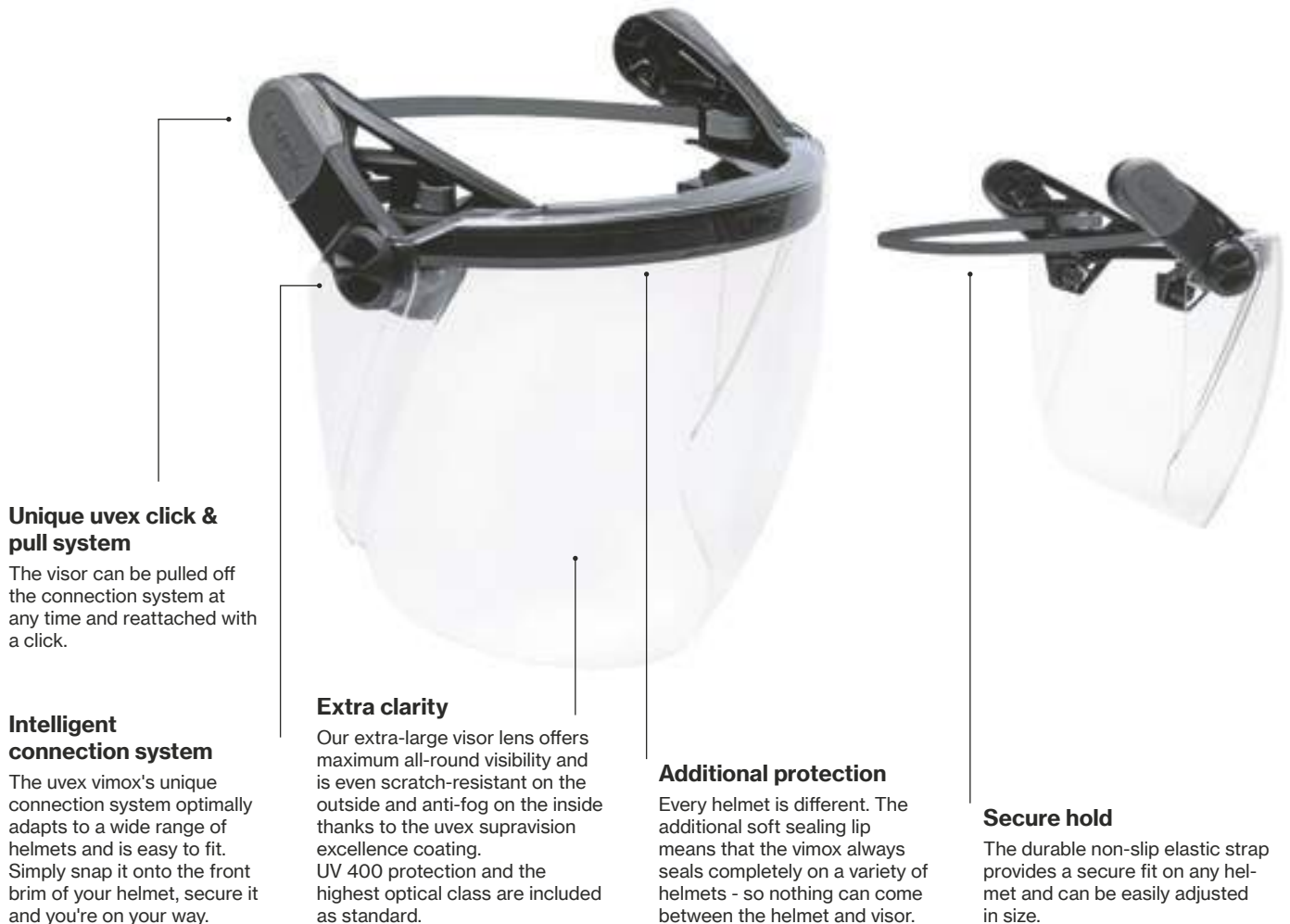

Ready to try one for all?

Over 20 helmets are compatible with the uvex vimox. Find out here if your current helmet is among them.

Visors and face protection

uvex vimox visor system



Click & pull system

The visor arm and the visor lens can be detached from the connection system via a lateral pull movement. Ideal for making the helmet a little easier to use when the visor is not needed.



Ergonomic relief

If the visor is not needed, it can be pushed out of the field of vision into a resting position. The visor then rests in a well-balanced and ergonomically secure position on the helmet.



Smart lens changing system

If the visor is damaged or has been in use for too long, it can be removed from the connection system by means of a screw and replaced.



9920001

uvex vimox	
Art. no.	9920001
Version	universal visor system for a wide range of helmets uvex supravision excellence coating click & pull system for visor arms
Standard Frame	EN 166, EN 170 black W 166 3 9 B CE
Lens	PC clear, UV 400 2C - 1.2 W 1 B 9 KN CE
Order unit	PC, individually packed in polythene bags
Outer packaging	16 PC per CT
Replacement lens	9921001, individually packed in polythene bags

Visors and face protection

uvex pheos visor system

uvex pheos visor

- polycarbonate visors with uvex supravision excellence coating technology
- visor is anti-fog on the inside and exceptionally scratch- and chemical-resistant on the outside. The anti-fogging properties are permanent, even after repeated cleaning
- easy to clean thanks to non-stick nanotechnology
- available with two mounting options: mechanical levers or automatic magnetic locks
- visors 9906002, 9906003 and 9906009 can be combined with the industrial protection helmets:
 - uvex pheos B-S-WR
 - Helmet for working at height uvex pheos alpine (visor adapter art. no. 9790067 required)
- visors uvex pheos SLB 1 (9906005 and 9906006) and uvex pheos SLB 2 (9906007 and 9906008) can be combined with the uvex pheos E-S-WR industrial safety helmet
- lenses can be changed
- fulfils standards EN 166 and EN 170
- certified for areas of application 3 (liquids) and 9 (molten metal and hot solids)
- uvex pheos SLB 1 visors are certified in accordance with GS-ET 29 as Class 1 visors for protection from electrical arcs (4kA)
- uvex pheos SLB 2 visors are certified in accordance with GS-ET 29 as Class 2 visors for protection from electrical arcs (7kA)
- you can find the combination options on the next page (on page 148)

Perfect 'resting position' for the visor and hearing protection

The visor can be locked above the helmet shell when not required and the hearing protection can be folded back. Everything fits closely to the helmet and is perfectly balanced over the body's centre of gravity. This

means the neck muscles are not placed under strain by any unnecessary weight, ensuring excellent wearer comfort and maximum freedom of movement.

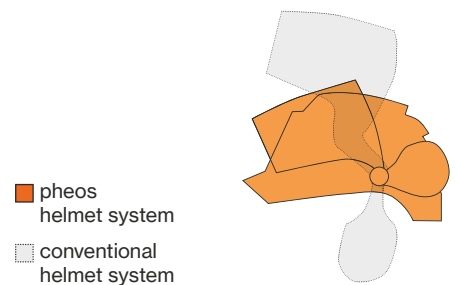

Reliable face protection

The anti-fog and scratch-resistant visor is made of high-quality polycarbonate that meet the highest optical quality class. The visor fits the helmet seamlessly, leaving no gaps.

The injection-moulded transparent peak provides protection against any particles penetrating the inside of the visor.



Magnetic and mechanical locking system

All visors are pre-assembled with a helmet adapter. This is clicked into the side helmet slot and remains permanently attached there.

With the magnetic locking system, the attachment parts, visor and earmuffs can be removed easily at any time without having to remove the helmet. The visor is released with a click of the lateral locking system. When re-assembled, the parts automatically snap back

into place. This allows the helmet to remain comfortably on your head.

If the product is equipped with a mechanical locking system, the earmuffs can be removed at any time via a bayonet connection. The mechanical visor remains permanently attached to the helmet.



Magnetic
locking system for visors and earmuffs with a magnetic connection



Mechanical
locking system for visors and earmuffs with a bayonet connection



Visors and face protection

uvex pheos visor system



9906002
9906005



9906007



9906003
9906006



9906008



9906009











Art. no.	uvex pheos 9906002	uvex pheos SLB 1 9906005	uvex pheos SLB 2 9906007
Version	uvex supravision excellence with mechanical levers and bayonet connection for hearing protection	uvex supravision excellence certified as Class 1 visor for protection from electrical arcs, with mechanical levers and bayonet connection for hearing protection	uvex supravision excellence certified as Class 2 visor for protection from electrical arcs with mechanical levers and chin protection and bayonet connection for hearing protection
Standard	EN 166, EN 170	EN 166, EN 170	EN 166, EN 170
Frame	black W 166 3 8-2 9 B CE 0196	black W 166 3 8-2 9 B CE 0196	black W 166 3 8-2 9 B CE 0196
Lens	PC clear UV 400 2C-1.2 W 1 B 9 KN CE 0196	PC clear UV 400 2C-1.2 W 1 B 8-1-0 9 KN CE 0196	PC blue UV 400 2C-1.2 W 1 B 8-2-0 9 KN CE 0196
Order unit	PC, individually packed in polythene bags	PC, individually packed in polythene bags	PC, individually packed in polythene bags
Outer packaging	24 PC per CT	24 PC per CT	14 PC per CT
Replacement lens	9906013, individually packed in polythene bags	9906012, individually packed in polythene bags	9906017, individually packed in polythene bags

Art. no.	uvex pheos magnetic 9906003	uvex pheos SLB 1 magnetic 9906006	uvex pheos SLB 2 magnetic 9906008	uvex pheos magnetic with chin guard 9906009
Version	uvex supravision excellence with magnetic levers	uvex supravision excellence certified as Class 1 visor for protection from electrical arcs, with magnetic levers	uvex supravision excellence certified as Class 2 visor for protection from electrical arcs with magnetic levers and chin protection	uvex supravision excellence with small chin guard and magnetic lever arms
Standard	EN 166, EN 170	EN 166, EN 170	EN 166, EN 170	EN 166, EN 170
Frame	black W 166 3 8-2 9 B CE 0196	black W 166 3 8-2 9 B CE 0196	black W 166 3 8-2 9 B CE 0196	black W 166 3 9 8-2 B CE 0196
Lens	PC clear UV 400 2C-1.2 W 1 B 9 KN CE 0196	PC clear UV 400 2C-1.2 W 1 B 8-1-0 9 KN CE 0196	PC blue UV 400 2C-1.2 W 1 B 8-2-0 9 KN CE 0196	PC clear UV 400 2C - 1.2 W 1 B 9 KN CE
Order unit	PC, individually packed in polythene bags	PC, individually packed in polythene bags	PC, individually packed in polythene bags	PC, individually packed in polythene bags
Outer packaging	20 PC per CT	20 PC per CT	14 PC per CT	20 PC per CT
Replacement lens	9906013, individually packed in polythene bags	9906012, individually packed in polythene bags	9906017, individually packed in polythene bags	9906014, individually packed in polythene bags

Visors and face protection

Combination options and accessories

Combination options uvex pheos visors

	Art. no.	Visor frame	Visor	Protection	Suitable helmets	Earmuffs
	9906002	mechanical	polycarbonate, clear	against mechanical influences (e.g. sparks, splinters)	all uvex pheos helmets with short brim	2600214 
	9906003	magnetic	polycarbonate, clear			2600215 
	9906009	magnetic	polycarbonate, clear with chin guard			
	9906005	mechanical	polycarbonate, clear with UV absorber	against electrical arcs up to 4 kA (kilo-amperes)	uvex pheos E-S-WR	2600214
	9906006	magnetic	polycarbonate, clear with UV absorber			2600215
	9906007	mechanical	polycarbonate, blue with UV absorber and chin section	against electrical arcs up to 7 kA (kilo-amperes)	uvex pheos E-S-WR	2600214
	9906008	magnetic	polycarbonate, blue with UV absorber and chin section			2600215

uvex pheos visor system accessories



	Visor adapter
Art. no.	9790067
Version	for combining with the helmet for working at height uvex pheos alpine for inserting on the inside of the visor's face cover (visor not included)
Order unit	PC, individually packed in polythene bags



	Helmet adapter
Art. no.	9790078
Version	helmet adapter for use with uvex pheos K2P magnet earmuffs (2600215) without visor, is only required if no visor is used
Order unit	PR, individually packed in polythene bags



	Sunglare filter/rain cover
Art. no.	9790074
Version	to protect against sun and rain, for insertion on the inside of the face cover of the visor, cannot be combined with the visors uvex pheos SLB 1 and uvex pheos SLB 2
Order unit	PC, individually packed in polythene bags



	Microfibre case
Art. no.	9954362
Version	cloth bag to store and transport uvex visors and uvex helmets, black
Order unit	PC, loose



	uvex pheos Adapter Magnet-Bajonett
Art. no.	2600235
Version	helmet adapter for use with uvex earmuffs with bayonet connection and magnetic pheos visor
Order unit	PR, packed in pairs in polythene bags

2600235

Visors and face protection

9790 · 9725 · 9726 · Forestry worker visor



uvex pheos forestry worker visor

- metal mesh visor for forestry work
- suitable for helmet uvex pheos ABS
- lens certification: W EN 1731:2006-F

Further information can be found on page 127.

uvex 9790

- robust polycarbonate visor for uvex industrial safety helmets and uvex helmet earmuffs 3200H, K1H and K2H
- for use during electrical work, a suitable electrician's helmet and dielectric helmet earmuffs must be used
- visor lens, helmet bracket and adapter must be ordered as individual parts
- additional adapters (art. no. 9924010) are required for the helmet and visor combination (without helmet earmuffs)

► helmet, helmet bracket and earmuffs are not included.



9790048



9790047



9924010

Lens	
Art. no.	9790048
Version	uncoated Short circuit electric arc classification Class 1 Fixed on helmet bracket 9790047
Standard	EN 166, EN 170, GS-ET 29
Lens	PC clear, UV 400 2C-1.2 W 1 B 8-1-0 9 CE 0196
Order unit	PC, individually packed in polythene bags
Outer packaging	100 PC per CT

	Helmet bracket	Adapter
Art. no.	9790047	9924010
Version	Helmet bracket for visor 9790 (9790048)	Adapter for attaching without earmuffs
Frame	black W 166 3 8-1 9 B CE 0196	
Order unit	PC, individually packed in polythene bags	PR, individually packed in polythene bags
Outer packaging	90 PC per CT	500 PR per CT

uvex 9725 · uvex 9726

- polycarbonate and cellulose acetate visors with adapters for attaching on the side helmet slots
- easy to change lenses
- not combinable with earmuffs
- suitable for helmets uvex airwing and uvex superboss

► Helmet not included!



9725514
9726014

	9725	9726
Art. no.	9725514	9726014
Replacement lens	9050517	9723017
Version	anti-fog on the inside	uncoated
	Material thickness: 1 mm	Material thickness: 1 mm
Standard	EN 166, EN 170	EN 166, EN 170
Frame	black W 166 3-F CE	black W 166 3-B CE
Lens	CA clear, UV 380 2C-1.2 W 1 FN CE	PC clear, UV 400 2C-1.2 W 1 B CE
Order unit	PC, individually packed in polythene bags	
Outer packaging	20 PC per CT	20 PC per CT

uvex pheos faceguard

Face protection system

This innovative face protection system consists of a height- and width-adjustable head strap and a choice of two different visor lenses. The high-quality polycarbonate visor features uvex coating technology to ensure that the wearer's field of vision remains fog-free for a long period of time and that the outside of the visor is scratch-resistant. The mesh visor is made of robust stainless steel and provides reliable protection when working outdoors. The earmuffs can be attached and removed quickly using a rotating mechanism. The system can be expanded with a wide range of accessories and adapted to suit the application.



The uvex multi-system in detail



The benefits of the uvex pheos faceguard at a glance:

- fully pre-assembled face protection system — ready to use at any time
- wide field of vision with the highest optical quality
- robust polycarbonate visor with anti-fog and scratch-resistant uvex supervision excellence coating or stainless steel mesh visor
- low weight and balanced centre of gravity to relieve the spine
- expandable system with high modularity
- unique combination: visor and bump cap
- replaceable individual parts
- comfortable fit even with glasses and respirators



Further information can be found at uvex-safety.com/en/pheosfaceguard (or scan the QR code).

uvex pheos faceguard

Face protection system

Designed to protect the face and neck

The uvex pheos faceguard has been ergonomically designed. The face protection system has been designed to evenly distribute the weight across the body's centre of gravity. The low weight and ergonomic centre of gravity supports a natural head posture, minimising strain on the neck and back. The narrow design and wide field of vision help to support the natural posture of the head and neck.



9790211



9790212



9790215

	uvex pheos faceguard	uvex pheos faceguard with hearing protection	uvex pheos faceguard mesh visor with hearing protection
Art. no.	9790211	9790212	9790215
Version	Pre-assembled system for head sizes 52–64 cm, Polycarbonate lens, uvex supravision excellence coating, Without hearing protection	Pre-assembled system for head sizes 52–64 cm, Polycarbonate lens, uvex supravision excellence coating, With earmuffs K1P (SNR: 28 dB), further information can be found on page 108	Pre-assembled system for head sizes 52–64 cm stainless steel mesh visor with high light transmission with hearing protectors K1P (SNR: 28 dB), further information can be found on page 108
Standard	EN 166, EN 170	EN 166, EN 170, EN 352	EN 1731, EN 352
Frame	W 166 39B CE	W 166 39B CE	W EN 1731:2006 F CE
Lens	PC, clear, UV 400 2C-1.2 W 1 B 9 KN CE 0196	PC, clear, UV 400 2C-1.2 W 1 B 9 KN CE 0196	Stainless steel mesh visor, light transmission > 60% W EN 1731:2006 F CE
Order unit	PC, individually packed in CT	PC, individually packed in CT	PC, individually packed in CT

Accessories



9760107

9760108



9906013



9790074



2600216



9790159



9790160



9790170

	replacement suspension harness	replacement sweatband	replacement lens visor	sun protection	hearing protection earplugs K1P	uvex pheos faceguard bump cap	Replacement lens	Sun/Neck protection
Art. no.	9760107	9760108	9906013	9790074	2600216	9790159	9790160	9790170
Version	Plastic suspension harness for head sizes 52–64 cm	Textile	Polycarbonate lens uvex supravision excellence coating	Protects against sun and rain is inserted on the visor	Earmuffs for uvex pheos faceguard SNR 28 dB	Bump cap for the uvex pheos faceguard system, hard shell ABS, black, 52–64 cm EN 812	replacement lens stainless steel mesh visor for uvex pheos faceguard	Textile with cooling function to protect against sunlight
Order unit	PC, individually packed in polythene bags	PC, individually packed in polythene bags	PC, individually packed in polythene bags	PC, individually packed in polythene bags	PR, in pairs in CT	PC, individually packed in polythene bags	PC, individually packed in polythene bags	PC, individually packed in polythene bags

Safety Helmets

uvex Visors · safety Goggles



9705014



9706514



9707014



9708514

uvex 9705 · uvex 9706

- cellulose acetate visor with integrated forehead cover
- easy to change lenses
- cannot be combined with safety helmets
- flip-up mechanism with continuous adjustment
- head size can be easily adjusted using a twist lock

uvex 9707 · uvex 9708

- cellulose acetate visor with integrated fore-head cover and additional protective cap made from impact-resistant polystyrene
- easy to change lenses
- flip-up mechanism with continuous adjustment
- head size can be easily adjusted using a twist lock

	visor 9705	visor 9706	visor 9707	visor 9708
Art. no.	9705014	9706514	9707014	9708514
Version	uncoated	anti-fog on the inside	uncoated	anti-fog on the inside
Standard	EN 166, EN 170	EN 166, EN 170	EN 166, EN 170	EN 166, EN 170
Frame	black	black	black	black
	W166 3-F DIN CE 0196	W166 3-F DIN CE 0196	W166 3 F DIN CE 0196	W166 3 F DIN CE 0196
Lens	CA clear, UV 380	CA clear, UV 380	CA clear, UV 380	CA clear, UV 380
	W 1 F DIN CE	W 1 FN DIN CE	W 1 F DIN CE	W 1 F DIN CE
Order unit	PC, individually packed in polythene bags			
Outer packaging	15 PC per CT	15 PC per CT	10 PC per CT	10 PC per CT
Replacement lens	9060017	9050517	9060017	9050517



Bump Caps

uvex u-cap sport

A wide range for many applications



LED lamp uvex u-cap sport, suitable for all u-cap sport variants available on page 135.

uvex u-cap sport

uvex u-cap sport						
Art. no.	9794409	9794403	9794404	9794442	9794422	9794424
Version	with short brim (4 cm), hard case made of ABS, textile cap made of cotton			with short brim (4 cm) and mesh webbing suspension harness, hard case made of ABS, textile cap made of cotton		
Standard	EN 812	EN 812	EN 812	EN 812	EN 812	EN 812
Colour	black	black	black	black	black	black
Sizes	52 to 54 cm	55 to 59 cm	60 to 63 cm	52 to 54 cm	55 to 59 cm	60 to 63 cm
Order unit	PC	PC	PC	PC	PC	PC
Outer packaging	60 PC per CT	60 PC per CT	60 PC per CT	60 PC per CT	60 PC per CT	60 PC per CT
Art. no.	9794400	9794401	9794402	9794443	9794423	9794425
Version	with long brim (7 cm), hard case made of ABS, textile cap made of cotton			with long brim (7 cm) and mesh webbing suspension harness, hard case made of ABS, textile cap made of cotton		
Standard	EN 812	EN 812	EN 812	EN 812	EN 812	EN 812
Colour	black	black	black	black	black	black
Sizes	52 to 54 cm	55 to 59 cm	60 to 63 cm	52 to 54 cm	55 to 59 cm	60 to 63 cm
Order unit	PC	PC	PC	PC	PC	PC
Outer packaging	60 PC per CT	60 PC per CT	60 PC per CT	60 PC per CT	60 PC per CT	60 PC per CT

uvex u-cap sport suspension harness

uvex u-cap sport suspension harness	
Art. no.	9794415
Version	soft, comfortable mesh webbing suspension harness increased wearer comfort in uvex u-cap sport bump caps
Standard	EN 812
Colour	black
Sizes	unysize
Order unit	PC
Outer packaging	60 PC per CT

Baseball cap

Baseball cap		
Art. no.	9794110	9794111
Version	with long brim (7 cm) without hard shell element	with short brim (4 cm) without hard shell element
Colour	black	black
Sizes	55 to 63 cm	55 to 63 cm
Order unit	PC	PC
Outer packaging	60 PC per CT	60 PC per CT

uvex u-cap

uvex u-cap sport · uvex u-cap sport vent · uvex u-cap sport hi-viz



9794407
9794408



9794430 9794444
9794420 9794416
9794421 9794417



9794480
9794481
9794482



9794490
9794491
9794492



LED lamp uvex u-cap sport, suitable for all u-cap sport variants available on page 135.

uvex u-cap sport

uvex u-cap sport		
Art. no.	9794407	9794408
Version	with long brim (7 cm), hard case made of ABS, textile cap made of cotton	
Standard	EN 812	EN 812
Colour	navy blue	navy blue
Sizes	55 to 59 cm	60 to 63 cm
Order unit	PC	PC
Outer packaging	60 PC per CT	60 PC per CT

uvex u-cap sport vent

uvex u-cap sport vent			
Art. no.	9794430	9794420	9794421
Version	with short brim (4 cm), hard case made of ABS, textile cap made of cotton and mesh fibre		
Standard	EN 812	EN 812	EN 812
Colour	black	black	black
Sizes	52 to 54 cm	55 to 59 cm	60 to 63 cm
Order unit	PC	PC	PC
Outer packaging	60 PC per CT	60 PC per CT	60 PC per CT
Art. no.	9794444	9794416	9794417
Version	with short brim (4 cm) and mesh webbing and mesh webbing interior, ABS hard shell, textile cap made of cotton and mesh fibre		
Standard	EN 812	EN 812	EN 812
Colour	black	black	black
Sizes	52 to 54 cm	55 to 59 cm	60 to 63 cm
Order unit	PC	PC	PC
Outer packaging	60 PC per CT	60 PC per CT	60 PC per CT

uvex u-cap sport hi-viz

uvex u-cap sport hi-viz						
Art. no.	9794482	9794480	9794481	9794492	9794490	9794491
Version	with short brim (4 cm), ABS hard shell, textile cap made of cotton in fluorescent colours, according to requirements with EN 471 – increased visibility and security for the user					
Standard	EN 812	EN 812	EN 812	EN 812	EN 812	EN 812
Colour	hi-viz yellow	hi-viz yellow	hi-viz yellow	hi-viz orange	hi-viz orange	hi-viz orange
Sizes	52 to 54 cm	55 to 59 cm	60 to 63 cm	52 to 54 cm	55 to 59 cm	60 to 63 cm
Order unit	PC	PC	PC	PC	PC	PC
Outer packaging	60 PC per CT	60 PC per CT	60 PC per CT	60 PC per CT	60 PC per CT	60 PC per CT

Safety helmets to match your corporate identity

Individual safety helmets

uvex gives you the option to customise all uvex helmets and bump caps so that your employees' equipment matches your corporate identity specifications.

Please contact the uvex service centre with your requests at any time.

Tel. +49 911 9736-0 · Email: Individualisierung@uvex.de

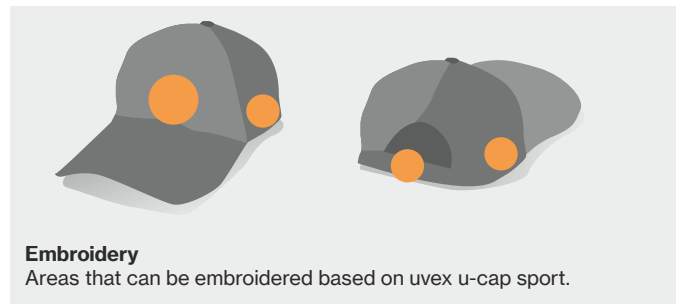
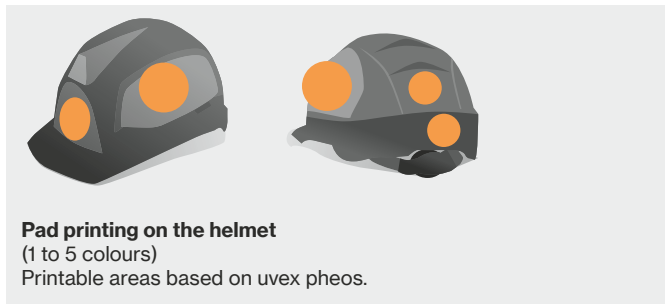

Customisation on the helmet	uvex pheos, uvex airwing, uvex superboss, uvex thermoboss	uvex pheos alpine
Special colour	from 300 units with supplemental charge from 600 units no additional cost	from 600 units no additional cost
new variant:		
– existing colour as a variant, electrician or chemist	from 300 units	
– existing colour with shortened brim	from 100 units	
– existing helmet, other interior, with chin strap	from 25 units	
Finish: Printed, sticker, reflex set	from 25 units reorder quantity: 25 units	

Customisation of bump caps	
Special colour	from 1,000 units
new variant:	
– with existing colour	from 600 units
Finish: Embroidered, printed	from 25 units

- Please note the following conditions:
- minimum order value 25 caps
- reorder quantity: 25 units
- number of colours to be embroidered: up to 14
- textile cap in special colour: from 1000 units
- vector file (.eps, .ai) and image file (.jpg, .pdf) required as template

How individual can you be?

We will be happy to advise you on the technical options for customising our safety helmets.

Safety Helmets

Overview

Art. no.	Name	Description	Colour	Page
2600235	Accessories	uvex pheos Adapter Magnet-Bajonett	black	148
2600236	Accessories	uvex pronamic Adapter Pull-Bajonett	clear	142
2600237	Accessories	uvex pronamic Adapter Push-Bajonett	clear	143
9050517	Accessories	Replacement lens, CA, non-fogging	clear	149/152
9060017	Accessories	Replacement lens, CA	clear	152
9705014	Accessories	Cellulose acetate protective visor	clear	152
9706514	Accessories	Antifog cellulose acetate protective visor, clear	clear	152
9707014	Accessories	Cellulose acetate protective visor	clear	152
9708514	Accessories	Antifog cellulose acetate protective visor, clear	clear	152
9720040	uvex perffexxion	Safety helmet	white	126
9720050	uvex perffexxion	Safety helmet	white	126
9720940	uvex perffexxion	Safety helmet	black	126
9720950	uvex perffexxion	Safety helmet	black	126
9723017	Accessories	Replacement lens, PC	clear	149
9725514	Accessories	Antifog cellulose acetate visor	clear	149
9726014	Accessories	Polycarbonate visor	clear	149
9731030	uvex pronamic B-WR	Safety helmet	white	119
9731130	uvex pronamic B-WR	Safety helmet	yellow	119
9731330	uvex pronamic B-WR	Safety helmet	red	119
9731530	uvex pronamic B-WR	Safety helmet	blue	119
9731031	uvex pronamic B-S-WR	Safety helmet	white	119
9731131	uvex pronamic B-S-WR	Safety helmet	yellow	119
9731331	uvex pronamic B-S-WR	Safety helmet	red	119
9731531	uvex pronamic B-S-WR	Safety helmet	blue	119
9731033	uvex pronamic S-KR	Safety helmet	white	119
9731133	uvex pronamic S-KR	Safety helmet	yellow	119
9731333	uvex pronamic S-KR	Safety helmet	red	119
9731533	uvex pronamic S-KR	Safety helmet	blue	119
9735030	uvex pronamic alpine	Safety helmet	white	121
9735031	uvex pronamic alpine	Safety helmet	white	121
9735130	uvex pronamic alpine	Safety helmet	hi-viz yellow	121
9735131	uvex pronamic alpine	Safety helmet	hi-viz yellow	121
9735230	uvex pronamic alpine	Safety helmet	hi-viz orange	121
9735231	uvex pronamic alpine	Safety helmet	hi-viz orange	121
9736030	uvex pronamic alpine E	Safety helmet	white	121
9736031	uvex pronamic alpine E	Safety helmet	hi-viz yellow	121
9736130	uvex pronamic alpine E	Safety helmet	hi-viz orange	121
9736131	uvex pronamic alpine E	Safety helmet	white	121
9736230	uvex pronamic alpine E	Safety helmet	hi-viz yellow	121
9736231	uvex pronamic alpine E	Safety helmet	hi-viz orange	121
9750020	uvex super boss	Safety helmet	white	124
9750120	uvex super boss	Safety helmet	yellow	124
9750520	uvex super boss	Safety helmet	blue	124
9754000	uvex thermo boss	Safety helmet	white	125
9754100	uvex thermo boss	Safety helmet	yellow	125
9754300	uvex thermo boss	Safety helmet	red	125
9760000	Accessories	Conventional suspension harness		133
9760001	Accessories	Suspension harness with rotating size adjusters		133
9760005	Accessories	Sweatband, synthetic leather		133
9760007	Accessories	Sweatband, textile/foam material		133
9760009	Accessories	Sweatband pheos alpine and pheos E-WR		127/133
9760011	Accessories	Suspension harness		133
9760012	Accessories	Suspension harness		133
9760014	Accessories	Wheel ratchet padding		133
9760106	Accessories	Replacement suspension harness pheos ABS		127
9760107	Accessories	Suspension harness pheos faceguard		151
9760108	Accessories	Sweatband for suspension harness		151
9762020	uvex airwing B	Safety helmet	white	124
9762021	uvex airwing B-S	Safety helmet	white	125
9762030	uvex airwing B-WR	Safety helmet	white	124
9762031	uvex airwing B-S-WR	Safety helmet	white	125
9762120	uvex airwing B	Safety helmet	yellow	124
9762121	uvex airwing B-S	Safety helmet	yellow	125
9762130	uvex airwing B-WR	Safety helmet	yellow	124
9762131	uvex airwing B-S-WR	Safety helmet	yellow	125
9762220	uvex airwing B	Safety helmet	orange	124
9762221	uvex airwing B-S	Safety helmet	orange	125
9762230	uvex airwing B-WR	Safety helmet	orange	124

Art. no.	Name	Description	Colour	Page
9762231	uvex airwing B-S-WR	Safety helmet	orange	125
9762320	uvex airwing B	Safety helmet	red	124
9762321	uvex airwing B-S	Safety helmet	red	125
9762330	uvex airwing B-WR	Safety helmet	red	124
9762331	uvex airwing B-S-WR	Safety helmet	red	125
9762420	uvex airwing B	Safety helmet	green	124
9762421	uvex airwing B-S	Safety helmet	green	125
9762430	uvex airwing B-WR	Safety helmet	green	124
9762431	uvex airwing B-S-WR	Safety helmet	green	125
9762520	uvex airwing B	Safety helmet	blue	124
9762521	uvex airwing B-S	Safety helmet	blue	125
9762530	uvex airwing B-WR	Safety helmet	blue	124
9762531	uvex airwing B-S-WR	Safety helmet	blue	125
9762920	uvex airwing B	Safety helmet	black	124
9770020	uvex pheos E	Safety helmet	white	130
9770026	uvex pheos E	Safety helmet with reflective sticker	white	131
9770030	uvex pheos E-WR	Safety helmet	white	130
9770031	uvex pheos E-S-WR	Safety helmet	white	130
9770036	uvex pheos E-WR	Safety helmet with reflective sticker	white	131
9770120	uvex pheos E	Safety helmet	yellow	130
9770126	uvex pheos E	Safety helmet with reflective sticker	yellow	131
9770130	uvex pheos E-WR	Safety helmet	yellow	130
9770131	uvex pheos E-S-WR	Safety helmet	yellow	130
9770136	uvex pheos E-WR	Safety helmet with reflective sticker	yellow	131
9770230	uvex pheos E-WR	Safety helmet	orange	130
9770231	uvex pheos E-S-WR	Safety helmet	orange	130
9770330	uvex pheos E-WR	Safety helmet	red	130
9770331	uvex pheos E-S-WR	Safety helmet	red	130
9770430	uvex pheos E-WR	Safety helmet	green	130
9770431	uvex pheos E-S-WR	Safety helmet	green	130
9770530	uvex pheos E-WR	Safety helmet	blue	130
9770531	uvex pheos E-S-WR	Safety helmet	blue	130
9770536	uvex pheos E-WR	Safety helmet with reflective sticker	blue	128
9770830	uvex pheos E-WR	Safety helmet	dark grey	130
9770832	uvex pheos E-S-WR	Safety helmet	dark grey	130
9770931	uvex pheos E-S-WR	Safety helmet	black	130
9772001	Accessories	Suspension harness IES		133
9772002	Accessories	Mount		134
9772020	uvex pheos B	Safety helmet	white	128
9772026	uvex pheos B	Safety helmet with reflective sticker	white	131
9772030	uvex pheos B-WR	Safety helmet	white	128
9772031	uvex pheos B-S-WR	Safety helmet	white	128
9772034	uvex pheos S-KR	Safety helmet	white	131
9772035	uvex pheos B-WR	Safety helmet with reflective sticker	white	131
9772038	uvex pheos B-S-WR	Safety helmet with reflective sticker	white	131
9772040	uvex pheos IES	Safety helmet	white	131
9772042	uvex pheos planet B-WR	Safety helmet	white	129
9772043	uvex pheos planet B-S-WR	Safety helmet	white	129
9772071	uvex pheos ABS B-S-WR	Safety helmet	white	127
9772090	uvex pheos S-KR Mips	Safety helmet	white	123
9772092	uvex pheos planet S-KR Mips	Safety helmet	white	129
9772120	uvex pheos B	Safety helmet	yellow	128
9772126	uvex pheos B	Safety helmet with reflective sticker	yellow	131
9772130	uvex pheos B-WR	Safety helmet	yellow	128
9772131	uvex pheos B-S-WR	Safety helmet	yellow	128
9772134	uvex pheos S-KR	Safety helmet	yellow	131
9772137	uvex pheos B-S-WR	Safety helmet with reflective sticker	yellow	131
9772138	uvex pheos B-WR	Safety helmet with reflective sticker	yellow	131
9772140	uvex pheos IES	Safety helmet	yellow	131
9772171	uvex pheos ABS B-S-WR	Safety helmet	yellow	127
9772190	uvex pheos S-KR Mips	Safety helmet	yellow	123
9772220	uvex pheos B	Safety helmet	orange	128
9772226	uvex pheos B	Safety helmet with reflective sticker	orange	131
9772230	uvex pheos B-WR	Safety helmet	orange	128
9772231	uvex pheos B-S-WR	Safety helmet	orange	128
9772234	uvex pheos S-KR	Safety helmet	orange	131
9772236	uvex pheos B-WR	Safety helmet with reflective sticker	orange	131
9772240	uvex pheos IES	Safety helmet	orange	131



Safety Helmets

Overview

Art. no.	Name	Description	Colour	Page
9772260	uvex pheos S-KR Mips	Safety helmet	hi-viz orange	123
9772271	uvex pheos ABS B-S-WR	Safety helmet	orange	127
9772320	uvex pheos B	Safety helmet	red	128
9772326	uvex pheos B	Safety helmet with reflective sticker	red	131
9772330	uvex pheos B-WR	Safety helmet	red	128
9772332	uvex pheos B-S-WR	Safety helmet	red	128
9772334	uvex pheos B-S-WR	Safety helmet with reflective sticker	red	131
9772335	uvex pheos S-KR	Safety helmet	red	131
9772340	uvex pheos IES	Safety helmet	red	131
9772371	uvex pheos ABS B-S-WR	Safety helmet	red	127
9772430	uvex pheos B-WR	Safety helmet	green	128
9772437	uvex pheos B-WR	Safety helmet with reflective sticker	green	131
9772520	uvex pheos B	Safety helmet	blue	128
9772526	uvex pheos B	Safety helmet with reflective sticker	red	131
9772530	uvex pheos B-WR	Safety helmet	blue	128
9772531	uvex pheos B-S-WR	Safety helmet	blue	128
9772534	uvex pheos S-KR	Safety helmet	blue	131
9772537	uvex pheos B-S-WR	Safety helmet with reflective sticker	blue	131
9772538	uvex pheos B-WR	Safety helmet with reflective sticker	blue	131
9772540	uvex pheos IES	Safety helmet	blue	131
9772832	uvex pheos B-S-WR	Safety helmet	dark grey	128
9772920	uvex pheos B	Safety helmet	black	128
9772930	uvex pheos B-WR	Safety helmet	black	128
9772932	uvex pheos B-S-WR	Safety helmet	black	128
9772936	uvex pheos B-WR	Safety helmet with reflective sticker	black	131
9773050	uvex pheos alpine	Safety helmet	white	126
9773150	uvex pheos alpine	Safety helmet	yellow	126
9773250	uvex pheos alpine	Safety helmet	orange	126
9773350	uvex pheos alpine	Safety helmet	red	126
9773450	uvex pheos alpine	Safety helmet	green	126
9773550	uvex pheos alpine	Safety helmet	blue	126
9773950	uvex pheos alpine	Safety helmet	black	126
9774236	uvex pheos	Forestry	yellow	127
9774237	uvex pheos	Forestry	orange	127
9774238	uvex pheos	Forestry	red	127
9790000	Accessories	Suspension harness thermo boss, super boss		133
9790004	Accessories	Sweatband artificial leather for thermo boss, super boss		133
9790005	Accessories	Leather chin straps		134
9790006	Accessories	Hygienic cap	white	132
9790007	Accessories	Forked chin straps		134
9790010	Accessories	Winter cap	black	132
9790012	Accessories	Winter cap	black	132
9790015	Accessories	Winter cap	black	132
9790016	Accessories	Winter cap	black	132
9790018	uvex pheos reflex set M	Reflective set		133
9790021	Accessories	Four-point chin strap		127/134
9790022	Accessories	Goggles clip/chin strap clip		134
9790023	Accessories	Pen holder		134
9790028	Accessories	LED head torch KS-7630-MCII		135
9790029	Accessories	LED head torch KS-6003-DUO		135
9790035	Accessories	Leather chin straps		134
9790047	Accessories	Helmet bracket	black	149
9790048	Accessories	Visor lens, PC	clear	149
9790062	Accessories	LED head torch pheos Lights		135
9790063	Accessories	LED head torch pheos Lights EX		135
9790064	Accessories	LED head torch u-cap sport		135
9790065	Accessories	Winter cap	hi-viz yellow	132
9790066	Accessories	Balaclava	black	132
9790067	Accessories	Visor adapter	black	148
9790068	Accessories	Winter cap	hi-viz orange	132
9790069	Accessories	Helmet adapter for LED head torch u-cap sport		135
9790071	Accessories	Helmet bag		134
9790074	Accessories	Sunglare filter/rain cover		148/151
9790075	Accessories	Neck protection	orange	132
9790076	Accessories	Neck protection	yellow	132
9790077	Accessories	Helmet slot sealing plug set		134
9790078	Accessories	Helmet adapter		148
9790086	Accessories	cooling neck protection		132
9790146	Accessories	Signal whistle		127
9790149	Accessories	Neck support		134

Art. no.	Name	Description	Colour	Page
9790150	Accessories	uvex pheos helmet sticker	silver	134
9790151	Accessories	uvex pheos helmet sticker	yellow	134
9790152	Accessories	uvex pheos helmet sticker	orange	134
9790153	Accessories	uvex pheos helmet sticker	red	134
9790154	Accessories	uvex pheos helmet sticker	green	134
9790155	Accessories	uvex pheos helmet sticker	blue	134
9790156	Accessories	uvex pheos helmet sticker	black	134
9790159	Accessories	uvex pheos faceguard bump cap	black	151
9790160	Accessories	Replacement lens mesh visor		142/151
9790166	Accessories	Business card holder		134
9790170	Accessories	Sun/Neck protection		151
9790210	Accessories	Replacement visor (metal)		127
9790211	uvex pheos faceguard	uvex pheos faceguard face protection system		151
9790212	uvex pheos faceguard	uvex pheos faceguard face protection system with hearing protection		151
9790215	uvex pheos faceguard	uvex pheos faceguard mesh visor with hearing protection		151
9794110	Baseball cap	with long brim, size 55 – 63 cm	black	154
9794111	Baseball cap	with short brim, size 55 – 63 cm	black	154
9794400	uvex u-cap sport	Impact cap, size 52 – 54 cm	black	154
9794401	uvex u-cap sport	Impact cap, size 55 – 59 cm	black	154
9794402	uvex u-cap sport	Impact cap, size 60 – 63 cm	black	154
9794403	uvex u-cap sport	Impact cap, size 55 – 59 cm	black	154
9794404	uvex u-cap sport	Impact cap, size 60 – 63 cm	black	154
9794407	uvex u-cap sport	Impact cap, size 55 – 59 cm	navy blue	155
9794408	uvex u-cap sport	Impact cap, size 60 – 63 cm	navy blue	155
9794409	uvex u-cap sport	Impact cap, size 52 – 54 cm	black	154
9794415	uvex u-cap sport	Suspension harness	black	154
9794416	uvex u-cap sport vent	Impact cap, size 55 – 59 cm	black	155
9794417	uvex u-cap sport vent	Impact cap, size 60 – 63 cm	black	155
9794420	uvex u-cap sport vent	Impact cap, size 55 – 59 cm	black	155
9794421	uvex u-cap sport vent	Impact cap, size 60 – 63 cm	black	155
9794422	uvex u-cap sport	Impact cap, size 55 – 59 cm	black	154
9794423	uvex u-cap sport	Impact cap, size 55 – 59 cm	black	154
9794424	uvex u-cap sport	Impact cap, size 60 – 63 cm	black	154
9794425	uvex u-cap sport	Impact cap, size 60 – 63 cm	black	154
9794430	uvex u-cap sport vent	Impact cap, size 52 – 54 cm	black	155
9794442	uvex u-cap sport	Impact cap, size 52 – 54 cm	black	154
9794443	uvex u-cap sport	Impact cap, size 52 – 54 cm	black	154
9794444	uvex u-cap sport vent	Impact cap, size 52 – 54 cm	black	155
9794480	uvex u-cap sport hi-viz	Impact cap, size 55 – 59 cm	hi-viz yellow	155
9794481	uvex u-cap sport hi-viz	Impact cap, size 60 – 63 cm	hi-viz yellow	155
9794482	uvex u-cap sport hi-viz	Impact cap, size 52 – 54 cm	hi-viz yellow	155
9794490	uvex u-cap sport hi-viz	Impact cap, size 55 – 59 cm	hi-viz orange	155
9794491	uvex u-cap sport hi-viz	Impact cap, size 60 – 63 cm	hi-viz orange	155
9794492	uvex u-cap sport hi-viz	Impact cap, size 52 – 54 cm	hi-viz orange	155
9906002	Accessories	uvex pheos Visor	clear	147
9906003	Accessories	uvex pheos magnetic Visor	clear	147
9906005	Accessories	uvex pheos SLB 1 Visor	clear	147
9906006	Accessories	uvex pheos SLB 1 magnetic Visor	clear	147
9906007	Accessories	uvex pheos SLB 2 Visor	blue	147
9906008	Accessories	uvex pheos SLB 2 magnetic Visor	blue	147
9906009	Accessories	uvex pheos magnetic with chin guard	black	147
9906012	Accessories	Replacement lens pheos Visor	clear	142/147
9906013	Accessories	Replacement lens pheos SLB 1 Visor	clear	142/147
9906014	Accessories	Replacement lens pheos Visor with chin guard	clear	142/147
9916000	Accessories	uvex pronamic	clear	142/147
9916001	Accessories	uvex pronamic with chin guard	clear	142
9916002	Accessories	uvex pronamic SLB 1	clear	142
9916003	Accessories	uvex pronamic SLB 2	blue	142
9916100	Accessories	uvex pronamic mesh visor	black	142
9916200	Accessories	uvex pronamic half visor	clear	142
9916201	Accessories	uvex pronamic half visor	grey	143
9906017	Accessories	Replacement lens pheos SLB 2 Visor	blue	143
9924010	Accessories	Adapter	black	149
9954362	Accessories	Cloth bag for uvex visors	black	148



Breathing Protection

Product system planet series › Breathing Protection

uvex has developed the **protecting planet** icon, to help raise awareness of its commitment to achieving increased sustainability. Based on the brand claim, **protecting people**, our sustainable approach integrates three core interlinked pillars – **ecology, economy** and **social responsibility**, that are incorporated throughout the business to improve our sustainability performance.

This explains the comprehensive audit, measurement and evaluation management process uvex undertakes along the entire value chain to ensure its products are as sustainable as possible.

uvex silv-Air 2310 planet

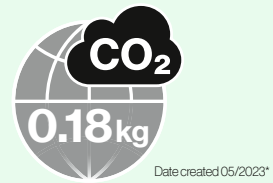

 **protecting planet**
by using recycled material

- › valve made from 95 percent recycled ABS
- › headband attachment made of 100 percent recycled PP
- › recycled ABS made of components from e.g. the automotive industry or white goods
- › recycled PP comes, for example, from used household appliances
- › total recycled content of the mask is 26.5 percent
- › significant improvement of the CO₂ footprint to 0.18 kg per mask

 **protecting planet**
by using environmentally-friendly packaging

- Packaging**
- › polybag made of 30 percent recycled material
 - › cartons made from more than 80 percent recycled paper

Headband attachment

100%

recycled PP

Valve

95%

recycled ABS

8762313



26.5%

recycled content of the total product

uvex silv-Air 2310 planet

- particle-filtering preformed mask with exhalation valve for **larger face shapes**
- valve and four-point headband attachment partially made of recycled material, 26.5 percent of the total product is made from recycled content
- polybags made of 30 percent recycled material
- flexible, adjustable nose clip so that the mask fits comfortably and securely
- very soft, all-around sealing lip for optimal wearer comfort and secure fit
- exhalation valve for reducing heat and humidity as well as noticeably reducing breathing resistance

uvex silv-Air 2310 planet

Art. no.	8762313
Version	FFP3 NR D preformed mask with valve
Colour	white
Order quantity multiple/Order unit	BOX
Content	15 PC, individually packed in BOX

The uvex brand is our responsibility

We have been producing and selling high-quality products for the protection of people in sport, leisure and work for **over 90 years**. And if you want to protect people, **you have to take responsibility**.

It is precisely from this mission that our obligation derives to act in a **sustainable, social and socially-responsible** manner.

uvex

Breathing Protection

Following our motto **protecting planet**, sustainability is a major focus for the respiratory protection product group. For single-use products with high consumption in particular, **improvements in the CO₂ footprint** play a decisive role.

In addition to the inclusion of our more sustainable **FFP3 cup-style mask, the uvex silv-air 2310 planet**, we are also adapting all of our other product families.

The aim is to **make the entire range more sustainable** and, as part of this, we are converting all our models that have plastic parts to use recycled material.

We constantly analyse other components of the mask for optimisations in order to further expand the mission of protecting planet for greater sustainability in the product group.

The strict requirements for health and environmental protection are always on our minds:



uvex hazardous substances list

List of "banned hazardous substances" – compliance is ensured by regular monitoring from independent test institutes.

All future valves made of

95%

recycled material

All future headband attachments made of

100%

recycled material



Average recycled content
for the uvex respiratory protection product group

30.2%

Calculated based on all models with plastic parts

EN149:2001+A1:2009

Respiratory protective devices – filtering half-masks for protection against particles

All uvex respirators are tested and approved in accordance with the **European standard 149**. This standard sets out a wide range of requirements for respirators, with the aim of providing the user with the highest level of protection and comfort.

The key tests defined in EN149 are:

- measuring inhalation and exhalation resistance
- testing the exhalation valve
- visual inspection (marking, instructions for use)
- determining the filtering efficiency (protection class)
- optional: carrying out the dolomite dust test

Detailed information about the standards and guidelines for respiratory protection is available at:

<https://ures.uvex.de>



The standard divides respirators into three protection classes according to their filtering efficiency and leakage:

FFP 1

FFP1 respirators have a filtering capacity of at least 80% and filter up to four times the respective occupational exposure limit (OEL*). These masks are suitable for particles that are neither toxic nor fibrogenic.

FFP 2

FFP2 respirators are suitable for smoke, particles and dusts that are noxious or harmful to health. They filter at least 94% of particles and can be used up to ten times the respective occupational exposure limit (OEL*).

FFP 3

With a filtering efficiency of at least 99%, FFP3 masks constitute the highest protection class. They filter up to 30 times the respective occupational exposure limit (OEL*) and are suitable for protecting against toxic particles, dusts and smoke.



So that you can see the protection class at a glance, the marking is **blue** on FFP1 masks, **orange** on FFP2 masks and **black** on FFP3 masks.



In addition to the standard tests, all uvex masks fulfil the additional requirement of the dolomite dust test and are therefore marked with the letter D. Therefore the uvex respiratory protection products ensure an excellent breathability, even in extremely dusty environments and during prolonged use.

All uvex respirators are in line with current EU legislation. All respiratory protective devices fall into PPE category III (high risks).

* OELs = The occupational exposure limit values (OELs) are the average concentration of a substance in the air in the workplace, up to which no damage (chronic or acute) is to be expected if employees work there for eight hours a day for five days a week. The OELs replace the maximum workplace concentration (MWC) and the technical reference concentration (TRC) – however, as long as both of these values are not yet fully taken into account in the OELs, they can still be used on an interim basis for assessing risks in the workplace.

The uvex breathing protection navigator

The fast route to finding the right respirator for your needs

Choosing the right respiratory protective devices is essential for ensuring the safety of the respective wearer and is a process that requires the utmost care. In order to choose the filtering respirator that meets your requirements, please observe the following points:



- the type, composition and concentration of the hazardous substances must be provided/known (note the CAS number and OEL). The measurement can be carried out by the employers' liability insurance association, for example. The minimum requirements for selected areas of application can be found on the next page.
- after determining the protection class required (FFP1, FFP2 or FFP3), the following table can be used to select a respirator model that meets the requirements of the respective work conditions.
- there must be a sufficient volume of oxygen in the environment. Please observe the statutory regulations in this regard. A minimum of 17 vol% is required in Germany.
- if further PPE is required, this must be compatible. uvex respirators are ideal for use in combination with uvex safety spectacles – see the compatibility table on page 167.
- respiratory protective devices are not suitable for people with beards, sideburns or deep scars near the respirator sealing lines as these prevent a secure fit. Please contact your safety officer for a custom solution.
- Masks marked "NR" should not be used for more than eight hours. Masks marked "R" may be used for up to 24 hours but must be cleaned after each period of use. Masks should be replaced without delay if the breathing resistance becomes noticeably higher.
- if a half-mask with gas filters is required for the work-space, please note that the uvex respirator models do not offer adequate protection.



Selection

Brief periods of use or lighter activities at normal ambient temperatures		
Protection class	Folding mask (with or without valve)	Cup-style mask (without or without valve)
FFP1	3100, 3110, 8103, 8113, 5100, 5100+, 5110, 5110+	2100, 2110, 7100, 7110
FFP2	3200, 3210, 8203, 8213, 5200, 5200+, 5210, 5210+	2200, 2210, 7200, 7210, 7212
FFP3	3310, 8313, 5310, 5310+	2310, 2312, 7310
Long periods of wear or hard, strenuous activities at increased ambient temperatures		
Protection class	Folding mask (with valve)	Cup-style mask (with valve)
FFP1	3110, 8113, 5110, 5110+	2110, 7110
FFP2	3210, 8213, 5210, 5210+	2210, 7210, 7212, 7233, 7232
FFP3	3310, 8313, 5310, 5310+	2310, 2312, 7310, 7333, 7330, 7312, 7317
With activated carbon layer to protect against unpleasant odours		
Protection class	Folding mask (with valve)	Cup-style mask (with valve)
FFP1	-	-
FFP2	3220, 5220+	2220, 7220
FFP3	5320+	7320, 2320, 2322

► The minimum requirements for selected areas of application can be found on page 166.

uvex silv-Air
Areas of application



Activity	Harmful substances	Protection class		
		FFP1	FFP2	FFP3
Wood processing				
Softwood: cutting and sanding	Fine particles, wood dust		■	
Hard wood (oak, beech, tropical woods, etc.): cutting and sanding	Fine particles, wood dust			■
Brushing/sanding paint	Fine colour particles		■	
Brushing/sanding paint (paints containing chrome)	Fine colour particles			■
Soluble paints containing copper/chrome/arsenic	Fine paint mist			■
Construction and ancillary building industry				
Cement work, plastering, tiling, roofing	Cement, plaster, tile or brick dust		■	
Masonry: cutting, drilling, demolition			■	
Asbestos: short periods of work	Fibres			■
Roof insulation: glass and mineral fibres	Dust and fibres		■	
Bodyfillers/stopper: Grinding	Dust		■	
Welding				
Welding aluminium and stainless steel	Metal and aluminium oxide fumes			■
Brazing	Fumes			■
Metalwork				
Metal: drilling, grinding, milling, angle grinding	Metal dust		■	
High-alloy steels and stainless steels: drilling, grinding, milling, angle grinding	Metal dust			■
Waste disposal and cleaning				
Refuse separation and disposal	Dust, fungi		■	
Medical waste disposal	Bacteria, spores			■
Sweeping floors	Dust (non-toxic)	■		
Radioactively contaminated particles	Dust			■
Agriculture				
Animal epidemics and treatment of animals with diseases	Bacteria, viruses			■
Work with fungal spores	Spores			■
Work with hay, grain and flour	Dust	■		
Medicine/care/health				
Allergies, pollen, household dust, animal fur	Dust, particles, spores		■	
Bacteria, viruses, infections, legionella bacteria	Bacteria, viruses			■

► These filter classes are minimum requirements and simply serve as a guide. It is the wearers' responsibility to make sure the breathing apparatus conforms to the requirements in terms of hazardous materials and concentration before use!

Perfect Match

Combination options of uvex silv-Air respirators with uvex safety eyewear

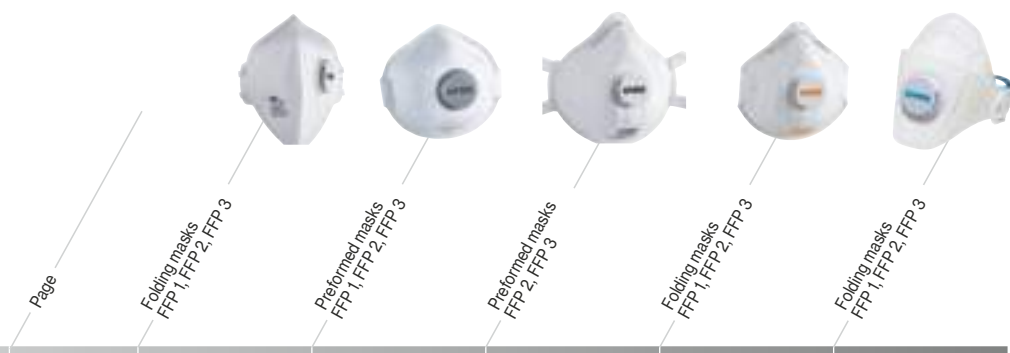

	Page	Folding masks FFP 1, FFP 2, FFP 3	Preformed masks FFP 1, FFP 2, FFP 3	Preformed masks FFP 2, FFP 3	Folding masks FFP 1, FFP 2, FFP 3	Folding masks FFP 1, FFP 2, FFP 3
uvex silv-Air premium	168 - 170					5100, 5100+, 5110, 5110+, 5200, 5200+, 5210, 5210+, 5220+, 5220+, 5310, 5310+, 5320+
uvex silv-Air e	171 - 173		7212, 7233, 7312, 7317, 7333	7232, 7330		
uvex silv-Air c	174 - 177	3100, 3110, 3200, 3210, 3220, 3310		2310, 2312, 2320, 2322	2100, 2110, 2200, 2210, 2220	
uvex i-3 uvex i-5	44 - 45 37	■	□	□	□	■
uvex pheos uvex sportstyle	42-43 40	■	■	□	■	■
uvex super fit uvex super g	51 50	■	■	□	□	■
uvex x-fit uvex x-fit pro	39 38	■	■	■	■	■
uvex i-vo	52	■	■	□	■	■
uvex i-works	47	■	□	□	□	■
uvex pheos cx2	41	■	□	□	□	■
uvex pheos cx2 sonic	59	■	■	■	■	■
uvex super OTG/uvex super OTG planet uvex super f OTG	56 57	■	■	■	■	■
uvex astrospec 2.0 uvex skyguard NT	49 -	■	□	□	■	■
uvex carbonvision	-	■	■	□	□	■
uvex ultrasonic/ultrasonic planet uvex ultravision	61 62 - 63	■	■	■	■	■
uvex megasonic/megasonic planet	58	■	□	□	■	■



These recommendations are based on experience. We recommend always carrying out wearability tests.

■ Perfect combination

□ Suitable to a limited extent

uvex silv-Air premium Respirators



- more sustainable mask family: the valve and headband attachment on all models are partly made of recycled material
- contour-optimised design for maximum wearer comfort and a secure fit
- available in two sizes for improved fit
- sealing lip (in the nose area for FFP1 and FFP2, in the nose and chin area for FFP3) and nose clip provide greater comfort and a very secure fit
- the masks are packaged individually to meet the highest hygiene requirements
- adjustable textile headband for greater protection and comfort
- optional: exhalation valve for reducing heat and humidity
- models in FFP2 and FFP3 against unpleasant odours available (5220+, 5320+)



The nose clip is easy to adjust, ensuring a particularly good fit.



The comfortable sealing lip offers maximum comfort and a reliable fit.



The masks are packaged individually and therefore meet the highest hygiene requirements.



The extra-wide textile headband ensures that the mask fits comfortably and securely.



Exhalation valve for reducing heat and humidity.

uvex silv-Air premium

FFP 1		FFP 2		FFP 3	
flat fold		flat fold		flat fold	
Small version	Large version	Small version	Large version	Small version	Large version
5100 NR D	5100+ NR D	5200 NR D	5200+ NR D		
5110 NR D	5110+ NR D	5210 NR D	5210+ NR D	5310 NR D	5310+ NR D
			5220+ NR D with carbon		5320+ NR D with carbon

uvex silv-Air premium Respirators, class FFP1 and FFP2



8735100
8745100

8735110
8745110

uvex silv-Air 5100 // 5110

- particle-filtering flat-fold mask for **small to medium face shapes**
- wide, seamless headband for ensuring a comfortable and secure fit
- incorporated nose clip that is easy to adjust
- comfortable sealing lip in the nose area for a reliable fit
- 5110: exhalation valve for reducing heat and humidity as well as noticeably reducing breathing resistance

	uvex silv-Air 5100		uvex silv-Air 5110	
Art. no.	8735100	8745100	8735110	8745110
Version	FFP1 NR D folding mask without valve – small version		FFP1 NR D folding mask with valve – small version	
Colour	white		white	
Order quantity multiple/ Order unit	BOX	BG	BOX	BG
Content	30 PC, individually packed in BOX		15 PC, individually packed in BOX	
	3 PC, individually packed in BG		3 PC, individually packed in BG	



8735101
8745101

8735111
8745111

uvex silv-Air 5100+ // 5110+

- particle-filtering flat-fold mask for **larger face shapes**
- wide, seamless headband for ensuring a comfortable and secure fit
- comfortable sealing lip in the nose area for a reliable fit
- incorporated nose clip that is easy to adjust
- 5110+: exhalation valve for reducing heat and humidity as well as noticeably reducing breathing resistance

	uvex silv-Air 5100+		uvex silv-Air 5110+	
Art. no.	8735101	8745101	8735111	8745111
Version	FFP1 NR D folding mask without valve – large version		FFP1 NR D folding mask with valve – large version	
Colour	white		white	
Order quantity multiple/ Order unit	BOX	BG	BOX	BG
Content	30 PC, individually packed in BOX		15 PC, individually packed in BOX	
	3 PC, individually packed in BG		3 PC, individually packed in BG	



8735200
8745200

8735210
8745210

uvex silv-Air 5200 // 5210

- particle-filtering flat-fold mask for **small to medium face shapes**
- wide, seamless headband for ensuring a comfortable and secure fit
- incorporated nose clip that is easy to adjust
- comfortable sealing lip in the nose area for a reliable fit
- 5210: exhalation valve for reducing heat and humidity as well as noticeably reducing breathing resistance

	uvex silv-Air 5200		uvex silv-Air 5210	
Art. no.	8735200	8745200	8735210	8745210
Version	FFP2 NR D folding mask without valve – small version		FFP2 NR D folding mask with valve – small version	
Colour	white		white	
Order quantity multiple/ Order unit	BOX	BG	BOX	BG
Content	30 PC, individually packed in BOX		15 PC, individually packed in BOX	
	3 PC, individually packed in BG		3 PC, individually packed in BG	



8735201
8745201

8735211
8745211

8735221
8745221

uvex silv-Air 5200+ // 5210+ // 5220+

- particle-filtering flat-fold mask for **larger face shapes**
- wide, seamless headband for ensuring a comfortable and secure fit
- incorporated nose clip that is easy to adjust
- comfortable sealing lip in the nose area for a reliable fit
- 5210+ / 5220+: exhalation valve for reducing heat and humidity as well as noticeably reducing breathing resistance
- 5220+: additional activated carbon filter for protection against odours, gases and vapours under the respective limit values

	uvex silv-Air 5200+		uvex silv-Air 5210+	
Art. no.	8735201	8745201	8735211	8745211
Version	FFP2 NR D folding mask without valve – large version		FFP2 NR D folding mask with valve – large version	
Colour	white		white	
Order quantity multiple/ Order unit	BOX	BG	BOX	BG
Content	30 PC, individually packed in BOX		15 PC, individually packed in BOX	
	3 PC, individually packed in BG		3 PC, individually packed in BG	

	uvex silv-Air 5220+	
Art. no.	8735221	8745221
Version	FFP2 NR D folding mask with valve and carbon – large version	
Colour	grey	
Order quantity multiple/ Order unit	BOX	BG
Content	15 PC, individually packed in BOX	
	3 PC, individually packed in BG	

uvex silv-Air premium

Respirators in protection class FFP3



8735310
8745310

uvex silv-Air 5310

- particle-filtering flat-fold mask for **small to medium face shapes**
- wide, seamless headband for ensuring a comfortable and secure fit
- comfortable sealing lip in the nose and chin area for a reliable fit
- incorporated nose clip that is easy to adjust
- exhalation valve for reducing heat and humidity as well as noticeably reducing breathing resistance

uvex silv-Air 5310		
Art. no.	8735310	8745310
Version	FFP3 NR D folding mask with valve – small version	
Colour	white	
Order quantity multiple/	BOX	BG
Order unit		
Content	15 PC, individually packed in BOX	3 PC, individually packed in BG



8735311
8745311

uvex silv-Air 5310+

- particle-filtering flat-fold mask for **larger face shapes**
- wide, seamless headband for ensuring a comfortable and secure fit
- comfortable sealing lip in the nose and chin area for a reliable fit
- incorporated nose clip that is easy to adjust
- exhalation valve for reducing heat and humidity as well as noticeably reducing breathing resistance

uvex silv-Air 5310+		
Art. no.	8735311	8745311
Version	FFP3 NR D folding mask with valve – large version	
Colour	white	
Order quantity multiple/	BOX	BG
Order unit		
Content	15 PC, individually packed in BOX	3 PC, individually packed in BG



8735321
8745321

uvex silv-Air 5320+

- particle-filtering flat-fold mask for **larger face shapes**
- wide, seamless headband for ensuring a comfortable and secure fit
- comfortable sealing lip in the nose and chin area for a reliable fit
- incorporated nose clip that is easy to adjust
- exhalation valve for reducing heat and humidity as well as noticeably reducing breathing resistance
- additional activated carbon filter for protection against odours, gases and vapours under the respective limit values

uvex silv-Air 5320+		
Art. no.	8735321	8745321
Version	FFP3 NR D folding mask with valve and carbon – large version	
Colour	grey	
Order quantity multiple/	BOX	BG
Order unit		
Content	15 PC, individually packed in BOX	3 PC, individually packed in BG

uvex silv-Air e
Respirators

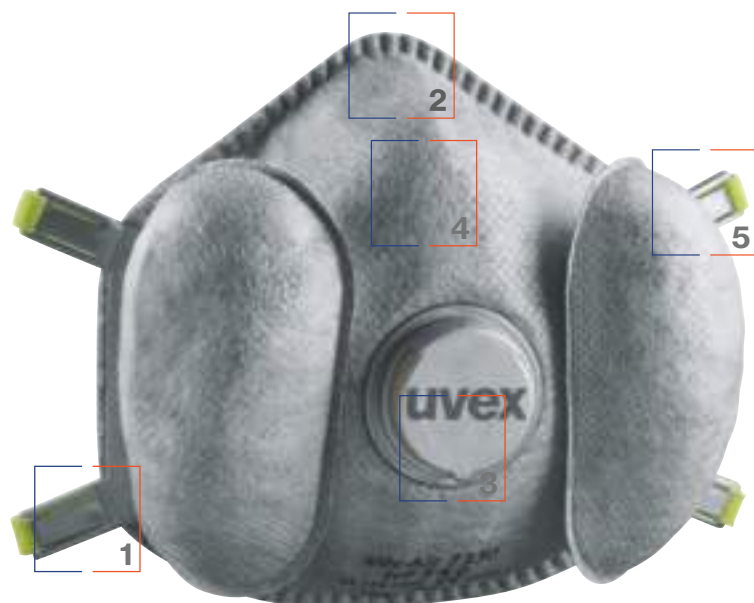

protecting planet
by using recycled material

- more sustainable mask family: the valve and headband attachment on all models are partly made of recycled material
- high-performance respirator – excellent protection with maximum wearer comfort
- the combination of a high-quality filter material and a larger filter surface noticeably reduces the breathing resistance
- the additional inhalation valves ensure a cool climate inside the mask (cooling effect)
- 3D nose geometry for a perfectly secure fit
- adjustable textile headband for a customised and comfortable fit
- the integrated sealing lip provides extremely high comfort



Adjustable headband for optimum fit

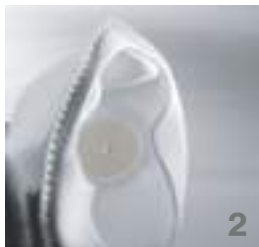

Perfectly shaped around the nose for secure positioning



Large inhalation valves ensure extremely low breathing resistance.



Nasal recess ensures a perfect fit for almost any nose shape.



Flexible 4-point headband attachment for a comfortable fit.

uvex silv-Air e					
FFP 1	FFP 2		FFP 3		
	cup style		flatfold	cup style	
	7212 NR D		8313 NR D	7312 R D	7317 R D
	7232 R D	7233 R D		7333 R D	7330 R D

uvex silv-Air e

High-performance respirators in protection class FFP2 and FFP3



How-to-use video



8787233
8787333

8787232
8787330

8788313

uvex silv-Air High-Performance – A new dimension in breathing protection

- particle-filtering preformed mask with exhalation valve and inhalation valves
- High-performance climazone system with three compartments for a comfortable, cool climate inside the mask
- flexible textile headband with neck clip for individual adjustment
- exhalation valve for reducing heat and humidity as well as noticeably reducing breathing resistance
- two extra filters with inhalation valves for lower breathing resistance and increased comfort due to easier air exchange
- very soft, all-around sealing lip for optimal wearer comfort and secure fit
- combination of 3D nose area and sealing lip ensures ideal fit for almost any nose shape

uvex silv-Air High-Performance – Perfect protection combined with maximum wearer comfort

- particle-filtering preformed mask with exhalation valve and inhalation valves
- High-performance climazone system with three compartments for a comfortable, cool climate inside the mask
- four-point headband attachment for a comfortable, individual and secure fit
- flexible, adjustable integrated nose clip
- exhalation valve for reducing heat and humidity as well as noticeably reducing breathing resistance
- two extra filters with inhalation valves for lower breathing resistance and increased comfort due to easier air exchange
- very soft, all-around sealing lip for optimal wearer comfort and secure fit
- nasal recess on the sealing lip ensures ideal fit for almost any nose shape

uvex silv-Air 8313

- particle-filtering flat-fold mask with exhalation valve
- hydrophobic material coating
- four-point headband attachment for a comfortable, individual and secure fit
- flexible, adjustable integrated nose clip
- very soft, all-around sealing lip for optimal wearer comfort and secure fit
- exhalation valve for reducing heat and humidity as well as noticeably reducing breathing resistance

	uvex silv-Air 7233	uvex silv-Air 7333
Art. no.	8787233	8787333
Version	FFP2 R D	FFP3 R D
	preformed mask with valves	preformed mask with valves
Colour	white	white
Order quantity multiples	BOX	BOX
Content	3 PC, packed in BOX	3 PC, packed in BOX

	uvex silv-Air 7232	uvex silv-Air 7330
Art. no.	8787232	8787330
Version	FFP2 R D	FFP3 R D
	preformed mask with valves	preformed mask with valves
Colour	silver grey	silver grey
Order quantity multiples	BOX	BOX
Content	3 PC, packed in BOX	3 PC, packed in BOX

uvex silv-Air 8313	
Art. no.	8788313
Version	folding mask FFP3 NR D with valve
Colour	white
Order quantity multiples	BOX
Content	15 PC, individually packed in BOX

uvex silv-Air e

High-performance respirators in protection class FFP2 and FFP3



8787317
8787318

8787312

8787212

uvex silv-Air 7317

- particle-filtering preformed mask with exhalation valve
- soft material edges for increased comfort
- very soft, all-around sealing lip for optimal wearer comfort and secure fit
- without nose clip (metal-free)
- four-point headband attachment for a comfortable, individual and secure fit
- exhalation valve for reducing heat and humidity as well as noticeably reducing breathing resistance
- extra-wide textile headband ensures that the mask fits comfortably and securely

uvex silv-Air 7312

- particle-filtering preformed mask with exhalation valve
- soft material edges for increased comfort
- very soft, all-around sealing lip for optimal wearer comfort and secure fit
- flexible, adjustable integrated nose clip
- four-point headband attachment for a comfortable, individual and secure fit
- exhalation valve for reducing heat and humidity as well as noticeably reducing breathing resistance

uvex silv-Air 7212

- particle-filtering preformed mask with exhalation valve
- soft material edges for increased comfort
- seamless headband for a comfortable, secure fit
- very soft, all-around sealing lip for optimal wearer comfort and secure fit
- flexible, adjustable integrated nose clip
- exhalation valve for reducing heat and humidity as well as noticeably reducing breathing resistance

uvex silv-Air 7317		
Art. no.	8787317	8787318
Version	FFP3 R D preformed mask with valve	
Colour	white	
Order unit	BOX	CT
Content	5 PC,	80 PC, individually
	packed in BOX	packed in CT

uvex silv-Air 7312	
Art. no.	8787312
Version	FFP3 R D preformed mask with valve
Colour	white
Order quantity multiples	BOX
Content	5 PC, packed in BOX

uvex silv-Air 7212	
Art. no.	8787212
Version	FFP2 NR D preformed mask with valve
Colour	white
Order quantity multiples	BOX
Content	15 PC, packed in BOX



Anatomically preformed nose area and integrated nosepiece within the filter material, ensures a perfect fit and the highest level of wearer comfort.



4-point headband attachment for a comfortable, secure fit of the mask.



The high-quality filter material ensures low breathing resistance, while the smooth white filter surface reduces the risk of contamination through "linting" in areas with strict hygiene standards.

uvex silv-Air c

Respirators in protection class FFP1, FFP2 and FFP3



protecting planet
by using recycled material

- more sustainable mask family: the valve and headband attachment on all models are partly made of recycled material
- soft material edges for greater comfort and wearer acceptance
- continuous textile headband ensures that the mask fits comfortably and securely
- optional: exhalation valve to reduce heat and humidity in the mask
- sealing lip (in the nose area for FFP1 and FFP2, all-round for FFP3) and nose clip provide maximum protection and comfort
- FFP2 and FFP3 models against unpleasant odours available (2220, 3220, 2320, 2322)
- FFP3 preformed masks are available in two sizes and also have a four-point headband attachment



1 The adjustable nose clip ensures an excellent individual fit and secure positioning.



2 The soft material edges prevent uncomfortable pressure points.



3 The seamless headband can be adjusted for an optimum fit.



4 The exhalation valve with a 360° opening ensures very low breathing resistance and a cooling effect climate inside the mask.



5 The upper face seal offers both a more secure positioning of the mask and increased wearer comfort.

		uvex silv-Air c											
		FFP 1		FFP 2			FFP 3						
cup style	flatfold												
		3100 NR D	3110 NR D	3200 NR D	3210 NR D	3220 NR D with carbon	3310 NR D						
flatfold	cup style												
		2100 NR D	2110 NR D	2200 NR D	2210 NR D	2220 NR D with carbon	2310 NR D	2312 NR D	2320 NR D with carbon	2322 NR D with carbon			

uvex silv-Air c

Filtering face masks, protection class FFP1



8763100
8743100



8763110
8743110

uvex silv-Air 3100 // 3110

- particle-filtering folding mask
- seamless headband and flexible, adjustable nose clip
- comfortable sealing lip in nose area for secure fit

- 3110: exhalation valve for reducing heat and humidity as well as noticeably reducing breathing resistance



uvex silv-Air 3100		
Art. no.	8763100	8743100
Version	FFP1 NR D folding mask without valve	
Colour	white	
Order quantity multiple/	BOX	BG
Order unit		
Content	30 PC, individually packed in BOX	3 PC, individually packed in BG

uvex silv-Air 3110		
Art. no.	8763110	8743110
Version	FFP1 NR D folding mask with valve	
Colour	white	
Order quantity multiple/	BOX	BG
Order unit		
Content	15 PC, individually packed in BOX	3 PC, individually packed in BG



8762100
8742101



8762110
8742111

uvex silv-Air 2100 // 2110

- particle-filtering preformed mask
- seamless headband and nose clip for a comfortable, secure fit
- comfortable sealing lip in nose area for secure fit

- 2110: exhalation valve for reducing heat and humidity as well as noticeably reducing breathing resistance

uvex silv-Air 2100		
Art. no.	8762100	8742101
Version	FFP1 NR D preformed mask without valve	
Colour	white	
Order quantity multiple/	BOX	BG
Order unit		
Content	20 PC, packed in BOX	3 PC, packed in BG

uvex silv-Air 2110		
Art. no.	8762110	8742111
Version	FFP1 NR D preformed mask with valve	
Colour	white	
Order quantity multiple/	BOX	BG
Order unit		
Content	15 PC, packed in BOX	3 PC, packed in BG

uvex silv-Air c

Filtering face masks, protection class FFP2



8763200
8743200

8763210
8743210

How-to-use video



8763220

uvex silv-Air 3200 // 3210

- particle-filtering folding mask
- seamless headband and flexible, adjustable nose clip
- comfortable sealing lip in nose area for secure fit
- 3210: exhalation valve for reducing heat and humidity as well as noticeably reducing breathing resistance

uvex silv-Air 3200		
Art. no.	8763200	8743200
Version	FFP2 NR D folding mask without valve	
Colour	white	
Order quantity multiple/ Order unit	BOX	BG
Content	30 PC, individually packed in BOX 3 PC, individually packed in BG	

uvex silv-Air 3210		
Art. no.	8763210	8743210
Version	FFP2 NR D folding mask with valve	
Colour	white	
Order quantity multiple/ Order unit	BOX	BG
Content	15 PC, individually packed in BOX 3 PC, individually packed in BG	

uvex silv-Air 3220

- particle-filtering folding mask with exhalation valve
- additional activated carbon filter against odours, gases and vapours below threshold
- seamless headband and flexible, adjustable nose clip
- comfortable sealing lip in nose area for secure fit
- exhalation valve for reducing heat and humidity as well as noticeably reducing breathing resistance

uvex silv-Air 3220		
Art. no.	8763220	
Version	FFP2 NR D folding mask with valve and carbon	
Colour	silver	
Order quantity multiple/ Order unit	BOX	
Content	15 PC, individually packed in BOX	



8762200
8742201

8762210
8742211

How-to-use video



8762220

uvex silv-Air 2200 // 2210

- particle-filtering preformed mask
- seamless headband and flexible, adjustable nose clip for a comfortable, secure fit
- comfortable sealing lip in nose area for secure fit
- 2210: exhalation valve for reducing heat and humidity as well as noticeably reducing breathing resistance

uvex silv-Air 2200		
Art. no.	8762200	8742201
Version	FFP2 NR D preformed mask without valve	
Colour	white	
Order quantity multiple/ Order unit	BOX	BG
Content	20 PC, packed in BOX 3 PC, packed in BG	

uvex silv-Air 2210		
Art. no.	8762210	8742211
Version	FFP2 NR D preformed mask with valve	
Colour	white	
Order quantity multiple/ Order unit	BOX	BG
Content	15 PC, packed in BOX 3 PC, packed in BG	

uvex silv-Air 2220

- particle-filtering preformed mask with exhalation valve
- additional activated carbon filter against odours, gases and vapours below threshold
- Seamless headband and flexible, adjustable nose clip for a comfortable, secure fit
- comfortable sealing lip in nose area for secure fit
- exhalation valve for reducing heat and humidity as well as noticeably reducing breathing resistance

uvex silv-Air 2220		
Art. no.	8762220	
Version	FFP2 NR D preformed mask with valve and carbon	
Colour	silver	
Order quantity multiple/ Order unit	BOX	
Content	15 PC, packed in BOX	

uvex silv-Air c

Filtering face masks, protection class FFP3



8763310
8743311

uvex silv-Air 3310

- particle-filtering folding mask with exhalation valve
- adjustable headband and flexible, adjustable nose clip for a comfortable, secure fit
- comfortable, all-around sealing lip for secure fit
- exhalation valve for reducing heat and humidity as well as noticeably reducing breathing resistance

uvex silv-Air 3310		
Art. no.	8763310	8743311
Version	FFP3 NR D folding mask with valve	
Colour	white	
Order quantity multiple/	BOX	BG
Order unit		
Content	15 PC, individually packed in BOX	3 PC, individually packed in BG



8762310
8742310

8762312
8742312

How-to-use video



8762320
8742320

8762322
8742322

uvex silv-Air 2310 // 2312

- 2310: particle-filtering preformed mask with exhalation valve for **larger face shapes**
- 2312: particle-filtering preformed mask with exhalation valve – ergonomically adapted for **smaller to medium-sized face shapes**
- four-point headband attachment and flexible, adjustable nose clip for a comfortable, secure fit
- very soft, all-around sealing lip for optimal wearer comfort and secure fit
- exhalation valve for reducing heat and humidity as well as noticeably reducing breathing resistance

uvex silv-Air 2310		
Art. no.	8762310	8742310
Version	FFP3 NR D preformed mask with valve – large version	
Colour	white	
Order quantity multiple/	BOX	BG
Order unit		
Content	15 PC, packed in BOX	3 PC, packed in BG

uvex silv-Air 2312		
Art. no.	8762312	8742312
Version	FFP3 NR D preformed mask with valve – small version	
Colour	white	
Order quantity multiple/	BOX	BG
Order unit		
Content	15 PC, packed in BOX	3 PC, packed in BG

uvex silv-Air 2320 // 2322

- 2320: particle-filtering preformed mask with exhalation valve for **larger face shapes**
- 2322: particle-filtering preformed mask with exhalation valve – ergonomically adapted for **smaller to medium-sized face shapes**
- four-point headband attachment and flexible, adjustable nose clip for a comfortable, secure fit
- very soft, all-around sealing lip for optimal wearer comfort and secure fit
- exhalation valve for reducing heat and humidity as well as noticeably reducing breathing resistance
- additional activated carbon filter against odours, gases and vapours below threshold values

uvex silv-Air 2320		
Art. no.	8762320	8742320
Version	FFP3 NR D preformed mask with valve and carbon – large version	
Colour	silver	
Order quantity multiple/	BOX	BG
Order unit		
Content	15 PC, packed in BOX	3 PC, packed in BG

uvex silv-Air 2322		
Art. no.	8762322	8742322
Version	FFP3 NR D preformed mask with valve and carbon – small version	
Colour	silver	
Order quantity multiple/	BOX	BG
Order unit		
Content	15 PC, packed in BOX	3 PC, packed in BG



uvex silv-Air 9517

Filtering face masks, protection class FFP2



8739518
8739519

MADE IN GERMANY 

uvex silv-Air 9517

- particle-filtering flat-fold mask without valve
- comfortable ear bands ensure that the mask fits securely
- flexible, adjustable integrated nose clip
- soft material edges for increased wearer comfort

uvex silv-Air 9517		
Art. no.	8739518	8739519
Version	FFP2 NR flat-fold mask with ear bands	
Colour	white	white
Order quantity multiples	BOX	CT
Content	10 PC, individually packed in BOX	1000 PC, individually packed in CT

uvex medical face mask type IIR

Medical face mask in accordance with EN 14683:2019 + AC:2019



MADE IN GERMANY

uvex medical face mask type IIR

- medical face mask type IIR for high bacterial filtering efficiency and protection against liquid splashes
- comfortable ear bands
- adjustable nose wire
- single use for adults
- Made in Germany
- certified medical device

uvex medical face mask type IIR					
Art. no.	8739520	8739521	8739522	8739523	8739524
Version	Medical face mask type IIR				
Colour	white	beige	grey	blue	green
Order quantity multiples	BOX	BOX	BOX	BOX	BOX
Content	50 PC, packed in BOX	50 PC, packed in BOX	50 PC, packed in BOX	50 PC, packed in BOX	50 PC, packed in BOX

The face mask is not PPE, but rather a medical device.

Standard EN 14683:2019 + AC:2019

EN 14683 regulates the requirements for medical face masks. The standard distinguishes between three protection classes: type I, type II and type IIR.

The classification is based on bacterial filtering efficiency, microbiological purity, breathing resistance and resistance to liquid splashes.

Classification	Type I	Type II	Type IIR
Bacterial filtering efficiency (BFE)	≥95%	≥98%	≥98%
Breathing resistance (Pa/cm ²)	<40	<40	<60
Splash resistance pressure (kPa)	not applicable	not applicable	≥16.0
Microbiological purity (CFU/g)	≤30	≤30	≤30

The uvex face mask corresponds to type IIR and therefore offers the highest level of protection.

uvex silv-Air Breathing protection

Quick overview of product features



The **360° exhalation valve** considerably reduces breathing resistance and build-up of heat and moisture in the mask.



The masks are **individually** packed and meet the highest standards of hygiene.



Comfortable all-round sealing lip
The soft sealing lip guarantees a secure, comfortable sealed positioning of the mask.



Carbon inside
The additional activated carbon layer incorporated in the filter material reduces unpleasant odours.



Soft sealing lip in the nose and chin area for a secure and comfortable fit.



The **3D nose area** ensures a comfortable fit, low leakage and prevents misting of uncoated eyewear.



Comfortable sealing lip in the nose area
The soft sealing lip in the nose area guarantees a secure, pressure-free fit.



High performance climate management
The mask offers extremely low breathing resistance due to the filter chambers connected with the inhalation valve. The climate management of the high performance mask guarantees optimum wearer comfort.



Comfort nose clip
The mask is fitted with a high-quality nose clip making it individually adjustable.



R labelling
The mask has been tested for reusability and has the required performance features for wearing during a second work shift.



Metal-free
The mask is completely metal-free and is manufactured entirely of skin-tolerant materials.



“NR” designation
The masks are not reusable and must therefore be disposed of after a work shift.



The **4-point headband attachment** allows an individual and secure fit, which can be perfectly adapted to meet the wearer’s requirements.



D labelling
The mask has undergone additional dolomite dust testing and therefore affords excellent breathability, even in extremely dusty environments and during longer periods of use.

uvex silv-Air
Overview

Art. no.	Name	Type	Features	Content per PU	PU per carton	Page
8735100	uvex silv-Air 5100	FFP1 folding mask without valve		30 PC	16 boxes	169
8735101	uvex silv-Air 5100+	FFP1 folding mask without valve		30 PC	16 boxes	169
8735110	uvex silv-Air 5110	FFP1 folding mask with valve		15 PC	16 boxes	169
8735111	uvex silv-Air 5110+	FFP1 folding mask with valve		15 PC	16 boxes	169
8735200	uvex silv-Air 5200	FFP2 folding mask without valve		30 PC	16 boxes	169
8735201	uvex silv-Air 5200+	FFP2 folding mask without valve		30 PC	16 boxes	169
8735210	uvex silv-Air 5210	FFP2 folding mask with valve		15 PC	16 boxes	169
8735211	uvex silv-Air 5210+	FFP2 folding mask with valve		15 PC	16 boxes	169
8735221	uvex silv-Air 5220+ with carbon	FFP2 folding mask with valve		15 PC	16 boxes	169
8735310	uvex silv-Air 5310	FFP3 folding mask with valve		15 PC	16 boxes	170
8735311	uvex silv-Air 5310+	FFP3 folding mask with valve		15 PC	16 boxes	170
8735321	uvex silv-Air 5320+ with carbon	FFP3 folding mask with valve		15 PC	16 boxes	170
8742101	uvex silv-Air 2100, Retail	FFP1 preformed mask without valve		3 PC	20 bags	175
8742111	uvex silv-Air 2110, Retail	FFP1 preformed mask with valve		3 PC	20 bags	175
8742201	uvex silv-Air 2200, Retail	FFP2 preformed mask without valve		3 PC	20 bags	176
8742211	uvex silv-Air 2210, Retail	FFP2 preformed mask with valve		3 PC	20 bags	176
8742310	uvex silv-Air 2310, Retail	FFP3 preformed mask with valve		3 PC	20 bags	177
8742312	uvex silv-Air 2312, Retail	FFP3 preformed mask with valve		3 PC	20 bags	177
8742320	uvex silv-Air 2320 with carbon, Retail	FFP3 preformed mask with valve		3 PC	20 bags	177
8742322	uvex silv-Air 2322 with carbon, Retail	FFP3 preformed mask with valve		3 PC	20 bags	177
8743100	uvex silv-Air 3100, Retail	FFP1 folding mask without valve		3 PC	20 bags	175
8743110	uvex silv-Air 3110, Retail	FFP1 folding mask with valve		3 PC	20 bags	175
8743200	uvex silv-Air 3200, Retail	FFP2 folding mask without valve		3 PC	20 bags	176
8743210	uvex silv-Air 3210, Retail	FFP2 folding mask with valve		3 PC	20 bags	176
8743311	uvex silv-Air 3310, Retail	FFP3 folding mask with valve		3 PC	20 bags	177
8745100	uvex silv-Air 5100, Retail	FFP1 folding mask without valve		3 PC	20 bags	169
8745101	uvex silv-Air 5100+, Retail	FFP1 folding mask without valve		3 PC	20 bags	169
8745110	uvex silv-Air 5110, Retail	FFP1 folding mask with valve		3 PC	20 bags	169
8745111	uvex silv-Air 5110+, Retail	FFP1 folding mask with valve		3 PC	20 bags	169
8745200	uvex silv-Air 5200, Retail	FFP2 folding mask without valve		3 PC	20 bags	169
8745201	uvex silv-Air 5200+, Retail	FFP2 folding mask without valve		3 PC	20 bags	169
8745210	uvex silv-Air 5210, Retail	FFP2 folding mask with valve		3 PC	20 bags	169
8745211	uvex silv-Air 5210+, Retail	FFP2 folding mask with valve		3 PC	20 bags	169
8745221	uvex silv-Air 5220+ with carbon, Retail	FFP2 folding mask with valve		3 PC	20 bags	169
8745310	uvex silv-Air 5310, Retail	FFP3 folding mask with valve		3 PC	20 bags	170
8745311	uvex silv-Air 5310+, Retail	FFP3 folding mask with valve		3 PC	20 bags	170
8745321	uvex silv-Air 5320+ with carbon, Retail	FFP3 folding mask with valve		3 PC	20 bags	170
8762100	uvex silv-Air 2100	FFP1 preformed mask without valve		20 PC	12 boxes	175
8762110	uvex silv-Air 2110	FFP1 preformed mask with valve		15 PC	12 boxes	175
8762200	uvex silv-Air 2200	FFP2 preformed mask without valve		20 PC	12 boxes	176
8762210	uvex silv-Air 2210	FFP2 preformed mask with valve		15 PC	12 boxes	176
8762220	uvex silv-Air 2220 with carbon	FFP2 preformed mask with valve		15 PC	12 boxes	176
8762310	uvex silv-Air 2310	FFP3 preformed mask with valve		15 PC	12 boxes	177
8762312	uvex silv-Air 2312	FFP3 preformed mask with valve		15 PC	12 boxes	177
8762313	uvex silv-Air 2310 planet	FFP3 preformed mask with valve		15 PC	12 boxes	161
8762320	uvex silv-Air 2320 with carbon	FFP3 preformed mask with valve		15 PC	12 boxes	177



uvex silv-Air

Overview

Art. no.	Name	Type	Features	Content per PU	PU per carton	Page
8762322	uvex silv-Air 2322 with carbon	FFP3 preformed mask with valve		15 PC	12 boxes	177
8763100	uvex silv-Air 3100	FFP1 folding mask without valve		30 PC	12 boxes	175
8763110	uvex silv-Air 3110	FFP1 folding mask with valve		15 PC	12 boxes	175
8763200	uvex silv-Air 3200	FFP2 folding mask without valve		30 PC	12 boxes	176
8763210	uvex silv-Air 3210	FFP2 folding mask with valve		15 PC	12 boxes	176
8763220	uvex silv-Air 3220 with carbon	FFP2 folding mask with valve		15 PC	12 boxes	176
8763310	uvex silv-Air 3310	FFP3 folding mask with valve		15 PC	12 boxes	177
8787212	uvex silv-Air 7212	FFP2 preformed mask with valve		15 PC	9 boxes	173
8787232	uvex silv-Air 7232 High-Performance	FFP2 preformed mask with three-chamber system		3 PC	12 boxes	172
8787233	uvex silv-Air 7233 High-Performance	FFP2 preformed mask with three-chamber system		3 PC	12 boxes	172
8787312	uvex silv-Air 7312	FFP3 preformed mask with valve		5 PC	12 boxes	173
8787317	uvex silv-Air 7317	FFP3 preformed mask with valve		5 PC	12 boxes	173
8787318	uvex silv-Air 7317	FFP3 preformed mask with valve		80 PC	1 carton	173
8787330	uvex silv-Air 7330 High-Performance	FFP3 preformed mask with three-chamber system		3 PC	12 boxes	172
8787333	uvex silv-Air 7333 High-Performance	FFP3 preformed mask with three-chamber system		3 PC	12 boxes	172
8788313	uvex silv-Air 8313	FFP3 folding mask with valve		15 PC	24 boxes	172
8739518	uvex silv-Air 9517	FFP2 folding mask without valve, with ear bands		10 PC	30 boxes	178
8739519	uvex silv-Air 9517	FFP2 folding mask without valve, with ear bands		1000 PC	1 carton	178
8739520	uvex face mask white	uvex medical face mask type IIR		50 PC	20 boxes	179
8739521	uvex face mask beige	uvex medical face mask type IIR		50 PC	20 boxes	179
8739522	uvex face mask grey	uvex medical face mask type IIR		50 PC	20 boxes	179
8739523	uvex face mask blue	uvex medical face mask type IIR		50 PC	20 boxes	179
8739524	uvex face mask green	uvex medical face mask type IIR		50 PC	20 boxes	179

Disposable Protective Clothing



uvex

uvex 5/6 air



Disposable Protection Clothing

Guide to standards and products

		uvex 5/6 air	uvex 5/6 air	uvex 5/6 comfort light	uvex 5/6 comfort	uvex 5/6 classic light	uvex 5/6 classic	uvex 4B	uvex 3B chem light	uvex 3B chem classic	uvex 3B chem classic+
		98173	89976	88497	98710	17595	98449	98375	89843	89880	88498
EN 14605	Liquid-tight coveralls								■	■	■
EN 14605	Spray-tight coveralls							■	■	■	■
EN 13034	Limited spray-tight coveralls (protection against liquid mist)	■	■	■	■	■	■	■	■		
ISO 13982-1	Particle-tight coveralls (protection against solid particles)	■	■	■	■	■	■	■	■	■	■
EN 1149-5	Protective clothing with antistatic properties (antistatic function only guaranteed if air humidity > 25%)	■	■	■	■	■	■	■	■	■	■
EN 14126	Protective clothing against infective agents					■	■	■	■	■	■
EN 1073-2	Protective clothing against particulate radioactive contamination (no protection against radioactive rays)	■	■	■		■	■	■	■	■	■
ISO 27065	Protective clothing for use with pesticides								■		

For more detailed information, please see the relevant certificates, technical data sheets or the endorsement on the product!

Defining environmental conditions

Are you exposed to dusty, damp or wet conditions during your work? To make it easier for you to select the right clothing for the job, we've categorised our overalls depending on their suitability for these environments. The bars indicate how suitable the product is for each setting. We also provide information on breathability so that you can take wearer comfort into account in your decision.

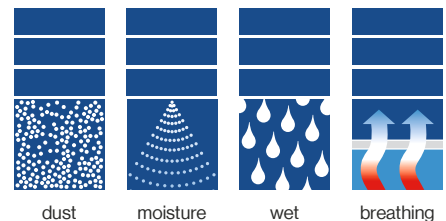

Identifying additional characteristics

In some work environments, there are additional requirements that you will need to take into account. These symbols indicate whether the items are free from silicone and paint wetting impairment substances.



Disposable protective clothing

Type 4 and Type 5/6 features and technologies

1

3 pieced hood

- optimum fit
- no limitations of view
- perfect match with respirators and goggles
- soft elastic on edge, feels comfortable

2

Zipper flap

- Zipper flap with integrated self adhesive tape
- easy to gum up
- additional security

3

Fingerloop

- finger loops made of soft elastic
- to keep the sleeves at the wrist
- additional security

4

Elastic in waistband

- integrated elastic in waist for optimal fit
- ideal wearer comfort

5

elasticated bands on arm and legs

- convenient closures thanks to elastics at wrist and ankles for additional security
- soft elastic on edge for high wearer comfort



Technologies

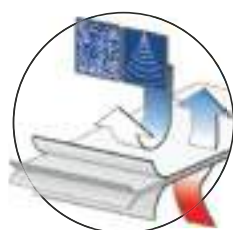

uvex SMS

- build out of several layers of polypropylene non woven material
- Mixure of spunbond and melt-blown non woven material for a perfect balance between stability and softness
- High degree on air permeability and breathability



uvex com4-Laminat

- non woven polypropylene material laminated with a microporous polyethylene film
- non woven material on the inside for a comfortable feeling
- material is not sticking on skin
- the microporous film provides a certain level of breathability

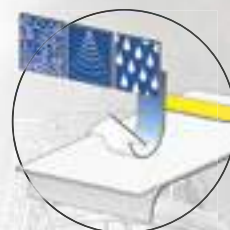

uvex Laminat light

- non woven polypropylene material laminated with a polyethylene film
- non woven material on the inside for a comfortable feeling
- material is not sticking on skin
- using the film is providing a higher level of protection, but reduces the breathability



uvex Laminat classic

- non woven polypropylene material laminated with a polypropylene film
- non woven material on the inside for a comfortable feeling
- material is not sticking on skin
- the polypropylene film provides an effective barrier against many organic and inorganic liquid chemicals

uvex 3B chem classic · uvex 3B chem classic+

Disposable coverall chemical protection Type 3B



89880



88498

Available from
December 2023

Equipment for item 88498:



The double zip flap makes it easy to put on



Double sleeves for extra safety



Double sleeves for extra safety

uvex 3B chem classic · uvex 3B chem classic+

General features:

- highly durable material combined with ultrasonically welded and taped seams ensure a great barrier and maximum of safety
- lightweight and durable material
- skin-friendly textile grip on inside

Protection features:

- offers protection against a wide range of chemicals
- optimal protection thanks to self-adhesive zipper flap

Comfort features:

- elasticated waistband, elasticated bands on hood, arms and legs for a perfect fit
- middle finger loops prevent sleeves sliding up the arm

Areas of application:

- handling organic and inorganic chemicals
- cleaning and maintenance work
- chemical and pharmaceutical industries
- food industry
- remediation of soil contamination and dismantling
- industrial cleaning and maintenance
- tank cleaning
- work with paints and varnishes
- disposal of hazardous materials
- agricultural industry
- waste water treatment and drainage construction
- waste management
- disaster response and emergency services
- veterinary medicine and disease control
- oil and petrochemicals

Certified in acc. with



	uvex 3B chem classic	uvex 3B chem classic+
Art. no.	89880	88498
Material	polypropylene spunbond, laminated with polypropylene film	polypropylene spunbond, laminated with polypropylene film
Colour	yellow	yellow
Sizes	S to 3XL	S to 3XL
Order unit	PC	PC
Outer	25 PC per CT	25 PC per CT



uvex-safety.com/en/overalls

uvex 3B chem light

Disposable coverall chemical protection Type 3B



89843

uvex 3B chem light

General features:

- light and highly flexible material for high wearer comfort with skin-friendly non-woven material inside

Protection features:

- ideal for cleaning work
- optimal protection thanks to self-adhesive zipper flap

Comfort features:

- elasticated waistband, elasticated bands on hood, arms and legs for optimal fit
- middle finger loops for securing the sleeves

Areas of application:

- handling low-concentration chemicals
- industrial and building cleaning
- ship building and automobile manufacture
- chemical and pharmaceutical industries
- handling paints and varnishes
- electronics
- handling and dismantling of asbestos
- remediation of contaminated sites
- livestock breeding and veterinary medicine
- waste management



Stitched and taped seams. Optimum protection against penetration by liquid aerosols and solid particles.

Certified in acc. with

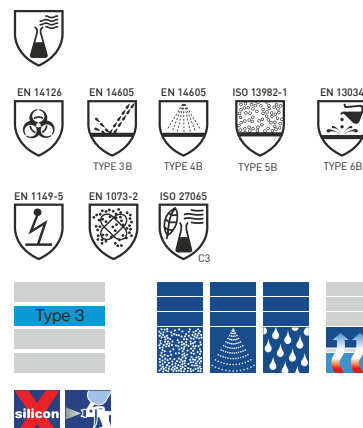

uvex 3B chem light	
Art. no.	89843
Material	polypropylene spunbond laminated with polyethylene film
Colour	white, yellow
Sizes	S to 3XL
Order unit	PC
Outer packaging	40 PC per CT

The chemicals included in this list are examples only. For a full overview for each individual garment, please consult the technical datasheets. You can also search our Chemical Expert System (see page 195).

Chemical	CAS no.	89843	89880
		Class in acc. EN 14325	Class in acc. EN 14325
Acetone	67-64-1	6 of 6	1 of 6
Acetonitrile	75-05-8	6 of 6	0 of 6
Iron(III) chloride (aq., 45%)	7705-08-0	–	6 of 6
Hydrofluoric acid (aq., 49%)	7664-39-3	6 of 6	6 of 6
Hydrofluoric acid (aq., 71 to 75%)	7664-39-3	–	5 of 6
Hydrofluoric acid in urea (62 to 64%)	7664-39-3	–	2 of 6
Formaldehyde (aq., 10%)	50-00-0	–	6 of 6
Isopropanol	67-63-0	6 of 6	6 of 6
Methanol	67-56-1	6 of 6	6 of 6
Sodium hydroxide, 50%	1310-73-2	6 of 6	6 of 6
Nitric acid, 69.5%	7697-37-2	–	6 of 6
Hydrochloric acid (aq., 37%)	7647-01-0	5 of 6	6 of 6
Sulphuric acid, 96%	7664-93-9	6 of 6	6 of 6
Hydrogen peroxide	7722-84-1	6 of 6	6 of 6

The information provided in the table was obtained in tests conducted under laboratory conditions (at temperatures of 21 ± 2°C). As additional stresses, such as higher temperatures and mechanical influences, are often present in practice, these values serve as a guide only. The information is provided without obligation and is not intended to replace your own suitability tests.

uvex

uvex 3B chem light



Blog



Flyer



You can find detailed information about this topic in our related blog post and flyer

Protection when handling crop protection products

In farming and forestry applications, workers are repeatedly exposed to hazardous chemical and biological substances. Depending on the type of application, the duration of the exposure and the specific effects of the hazardous substance, it may be necessary to wear personal protective equipment. In addition to respiratory protection and gloves, appropriate chemical protection clothing is an important component of the wearer's protective equipment.

In addition to the uvex 3B chem light, which is certified in accordance with EN ISO 27065 specifically for the handling of crop protection products, there are other protective suits that can be used.

You can find more information in our downloadable flyer "Certified protective equipment when using crop protection products" and our blog post on the topic "Pesticides: Personal protective equipment when handling crop protection products".

uvex 4B

Disposable coverall chemical protection type 4B



98375



89094



Stitched and taped seams. Optimum protection against penetration by liquid aerosols and solid particles.



uvex 4B

General features:

- light and highly flexible material for high wearer comfort lined with skin-friendly non-woven material inside

Protection features:

- taped seams for optimal protection
- self-adhesive zipper flap for optimal protection

Comfort features:

- elasticated waistband, elasticated bands on hood, arms and legs for optimal fit
- middle finger loops prevent sleeves sliding up the arm

Areas of application:

- low-pressure industrial cleaning and building cleaning
- ship building and automobile manufacture
- chemical and pharmaceutical industries
- handling paints and varnishes
- agriculture and horticulture
- pest control
- electronics
- work with asbestos and dismantling
- remediation of contaminated sites
- pharmaceutical industry and laboratories
- sampling
- livestock breeding and veterinary medicine
- waste management

Certified in acc. with



Art. no.	uvex 4B 98375	uvex 4B with overshoes 89094
Material	polypropylene spunbond, laminated with polyethylene film	polypropylene spunbond, laminated with polyethylene film
Colour	white, orange	white, orange
Sizes	S to 3XL	S to 3XL
Order unit	PC	PC
Outer packaging	40 PC per CT	40 PC per CT



uvex-safety.com/en/overalls

uvex 5/6 classic

Disposable coverall chemical protection Type 5/6



uvex 5/6 classic

General features:

- extremely lightweight and breathable material guarantees an excellent combination of comfort and safety
- skin-friendly and soft non-woven material on the inside

Protection features:

- self-adhesive zipper flap for optimal protection

Comfort features:

- elasticated waistband, elasticated bands on hood, arms and legs for a perfect fit
- middle finger loops prevent sleeves sliding up the arm

Areas of application:

- handling chemicals in dust and powder form
- varnishing and protection against paint splashes
- fibreglass production and processing
- industrial cleaning and maintenance
- automotive industry
- grinding and polishing
- cement manufacture
- mining and quarrying
- demolition and refurbishment
- working with asbestos
- wood and metal processing
- construction industry
- pharmaceutical industry

► other articles on request

Certified in acc. with



EN 14126



ISO 13982-1



EN 13034

TYPE 5B

TYPE 6B



EN 1149-5



EN 1073-2

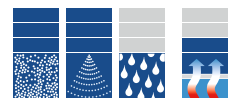

	uvex 5/6 classic	uvex 5/6 classic mF	uvex 5/6 classic light
Art. no.	98449	98759	17595
Material	polypropylene spunbond, laminated with polyethylene film	polypropylene spunbond, laminated with polyethylene film	polypropylene spunbond, laminated with polyethylene film
Colour	white	white	white
Sizes	S to 3XL	S to 3XL	S to 3XL
Order unit	PC	PC	PC
Outer packaging	50 PC per CT	50 PC per CT	50 PC per CT



uvex-safety.com/en/overalls

uvex 5/6 comfort

Disposable coverall chemical protection Type 5/6



98710



88497



98710: Breathable polyethylene laminate combined with an air permeable SMS back section to provide a high level of moisture management and breathability.



88497: Breathable polyethylene laminate combined with an air permeable SMS back section to provide a high level of moisture management and breathability.



uvex 5/6 comfort

General features:

- the combination of polyethylene laminate and a SMS back section provides a high level of moisture management, without reducing protection

Protection features:

- 98710: bound seams in contrasting colour
- 88497: with inside overlock seam
- self-adhesive zipper flap for optimal protection

Comfort features:

- optimal fit with elasticated waistband, elasticated bands on the hood, arms and legs
- middle finger loops prevent sleeves sliding up the arm

Areas of application:

- handling chemicals in dust and powder form
- varnishing and protection against paint splashes
- fibreglass production and processing
- industrial cleaning and maintenance
- automotive industry
- grinding and polishing
- cement manufacture
- mining and quarrying
- demolition and refurbishment
- working with asbestos
- wood and metal processing
- construction industry
- cleanroom applications
- pharmaceutical industry

Certified in acc. with

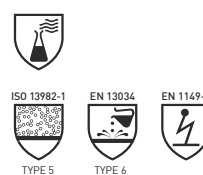

	uvex 5/6 comfort	uvex 5/6 comfort light
Art. no.	98710	88497
Material	Main material: polypropylene spunbond, laminated with polyethylene film back: SMS spunbond	Main material: polypropylene spunbond, laminated with polyethylene film back: SMS spunbond
Colour	white, lime	white
Sizes	S to 3XL	S to 3XL
Order unit	PC	PC
Outer packaging	40 PC per CT	40 PC per CT

uvex 5/6 air

Disposable coverall chemical protection Type 5/6



98173



89976



uvex 5/6 air

General features:

- excellent moisture management
- ideal for warm working environments and extended periods of wear

Protection features:

- optimal protection in dusty environments
- self-adhesive zipper flap for optimal protection

Comfort features:

- optimal fit with elasticated waistband, elasticated bands on hood, arms and legs
- middle finger loops prevent sleeves sliding up the arm

Areas of application:

- handling chemicals in dust and powder form
- working with asbestos
- fibreglass, ceramic fibre and synthetic resin production and processing
- wood and metal processing
- construction industry
- automotive industry
- grinding and polishing
- cement manufacture
- mining and quarrying
- refurbishment and renovation
- pharmaceutical industry
- repair work

Certified in acc. with



ISO 13982-1

EN 13034



TYPE 5

TYPE 6



EN 1149-5

EN 1073-2



Type 5/6

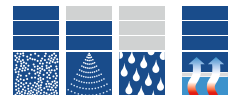

uvex 5/6 air		
Art. no.	98173	89976
Material	polypropylene spunbond	polypropylene spunbond
Colour	white	blue
Sizes	S to 3XL	S to 3XL
Order unit	PC	PC
Outer packaging	50 PC per CT	50 PC per CT



uvex-safety.com/en/overalls

Disposable chemical protection

Accessories



9875200



9875300



9874946
9874948



9875046



8935346



8909746



8909546



Hood · Gauntlets · Overshoes · Overboots

	Hood	Gauntlets	Overshoes		Overboot
Art. no.	9875200	9875300	9874946	9874948	9875046
Sizes	one size fits all	one size fits all	42 to 46	46 to 48	42 to 46
Version	with velcro fastening	elasticated band on both ends	opening with elasticated band		opening with elasticated band and tie
Material	polypropylene spunbond, laminated with polyethylene film	polypropylene spunbond, laminated with polyethylene film	polypropylene spunbond, laminated with polyethylene film		polypropylene spunbond, laminated with polypropylene film
Colour	white	white	white		white
Order unit	BG	BG	BG		BG
Content	50 PC, loose	50 PR, loose	100 PR, loose		50 PR, loose

	Overboot	Overshoe with anti-slip	Overboots with anti-slip
Art. no.	8935346	8909746	8909546
Sizes	42 to 46	42 to 46	42 to 46
Version	opening with elasticated band and tie	with anti-slip sole, elasticated opening improved fit	with anti-slip sole, elasticated opening with band improved fit
Material	polypropylene spunbond, laminated with polypropylene film	polypropylene spunbond, laminated with polyethylene film	polypropylene spunbond, laminated with polyethylene film
Colour	yellow	white	white
Order unit	BG	BG	BG
Content	30 PR, loose	100 PR, loose	25 PR, loose

Disposable chemical protection

Protection against infectious diseases

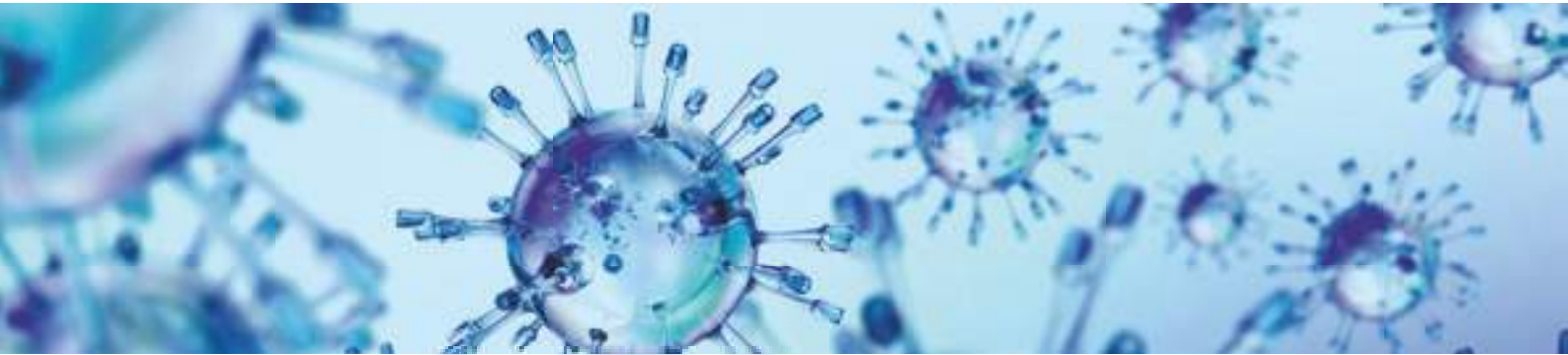

Workers may come into contact with biological substances in a wide range of situations. Appropriate personal protective equipment must be used to prevent potential infection.

Clothing designed to provide protection against infectious diseases establishes a physical barrier between the wearer's skin and the source of the infection, and prevents the disease from spreading to other people or environments.

Generally, micro-organisms such as bacteria, fungi and viruses are classed as biological substances. A detailed definition is provided in EU Directive 2000/54/EC. The crucial common denominator between all of these materials is that they can cause infections, trigger allergies, or produce a toxic effect.

Biological substances are placed in one of four categories depending on the infection risk they present:

Risk group 1:
Biological substances that are unlikely to cause disease in humans.

Risk group 2:
Biological substances that can cause human disease and might be a hazard to workers, but are unlikely to spread to the community; there is usually effective prophylaxis or treatment available.

Risk group 3:
Biological substances that can cause severe human disease and present a serious hazard to workers; they may present a risk of spreading to the community, but there is usually effective prophylaxis or treatment available.

Risk group 4:
Biological substances that cause severe human disease and are a serious hazard to workers; they may present a high risk of spreading to the community, and there is usually no effective prophylaxis or treatment available.

The risk groups of each biological substance are described in detail in the annex to EU Directive 2000/54/EC.

- Typical applications in which workers may be exposed to infectious substances include:
- Waste water treatment and drainage work
 - Waste disposal
 - Agriculture
 - Food industry
 - Work that involves contact with animals and/or products of animal origin
 - Healthcare, hospitals, emergency services

A detailed list of all biological substances that you may be exposed to in various applications, and the potential diseases associated with these substances, can be found in a number of publications, including the BGIA Report 1/2013.

Protective clothing in accordance with EN 14126:2003

The EN 14126 standard defines the performance requirements for clothing designed to protect against infectious diseases. The defined test procedures focus on the medium that contains the micro-organisms, such as fluids, aerosols or solid dust particles. Due to the heterogeneous nature of the micro-organisms, it is not possible to define performance criteria for them.

The tests stipulated by the standard relate only to the material; seam technologies are not taken into account. Taped seams provide a higher level of protection, as the micro-organisms are small enough to penetrate through the tiny needle holes along the seam. The entire protective suit must also be certified as chemical protection clothing (see page 195).

Wearing appropriate protective clothing does not provide complete, guaranteed protection against all chemical risks. It is also essential that you put on and remove the PPE correctly to ensure safety (see page 196). Any person who assists in the removal of the clothing is also exposed to the risk of contamination.

Model	uvex 3B chem classic	uvex 3B chem classic+	uvex 3B chem light	uvex 4B	uvex 5/6 classic	uvex 5/6 classic light
Art. no.	89880	88498	89843, 89094	98375	98449	17595
ISO/FDIS 16604/16603 Resistance to contaminated liquids	6 of 6	6 of 6	6 of 6	6 of 6	6 of 6	6 of 6
EN 14126 appendix A Resistance due to mechanical contact with substances containing contaminated liquids	6 of 6	6 of 6	6 of 6	6 of 6	6 of 6	6 of 6
ISO/DIS 22611 Resistance to contaminated liquid aerosols	3 of 3	3 of 3	3 of 3	3 of 3	3 of 3	3 of 3
ISO/DIS 22612 Resistance to contaminated solid particles	3 of 3	3 of 3	3 of 3	3 of 3	3 of 3	3 of 3

Disposable Protection Clothing

Guide to standards and products

Your team's safety at the forefront

From light liquid splashes to hazardous chemicals and radioactive material – employees face various hazards in the course of their daily work. To simplify the process of selecting appropriate protective clothing, the European Union has defined harmonised standards for different protection classes (also called types) for chemical protection – Category III.

The protection type is confirmed by certification and indicates the kind of exposure (dust, liquid, gas) for which the suit is suitable. The attainment of the individual types only ensures the minimum requirements necessary for certification. Please refer to our technical datasheets for details of the individual tests.

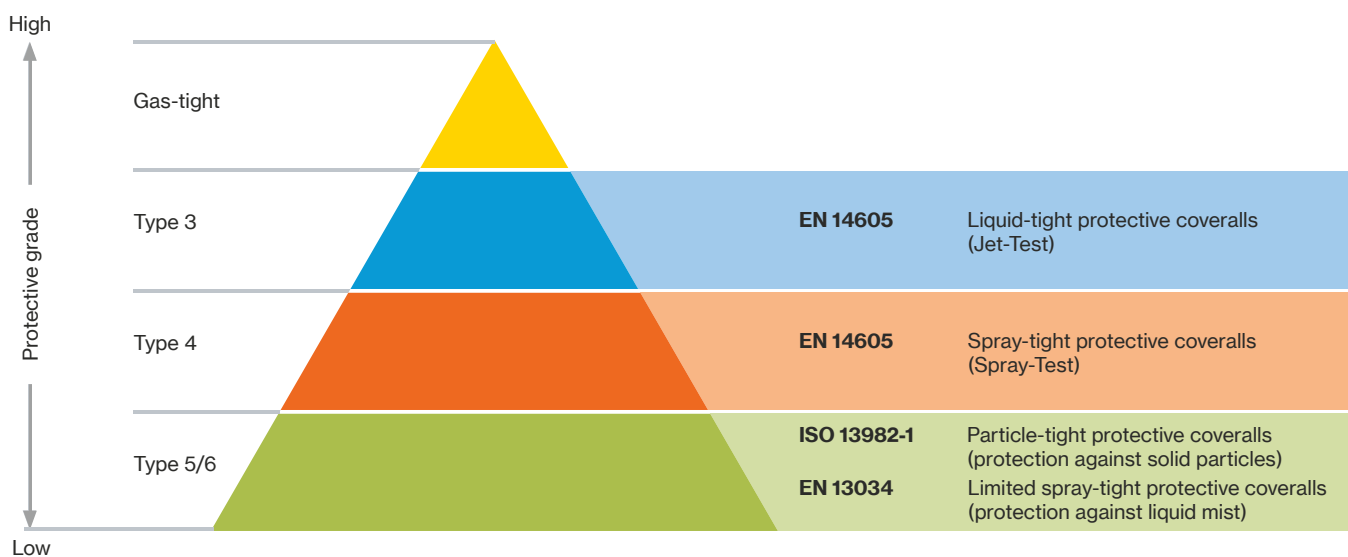

For optimum protection of your team at all times, the breakthrough times of permeation must be taken into account for protective coveralls. uvex protection clothing has undergone the required permeation tests. More information on the breakthrough times of specific chemicals can be found in the technical datasheets or in the uvex Chemical Expert System

Online chemicals database

The uvex Chemical Expert System (CES) offers an extensive chemicals database for choosing the appropriate disposable overall for working with hazardous substances.

As a user, you can create a personal permeation list or receive advice from our specialists. It only takes a few clicks of the mouse to find the right disposable safety clothing and chemical safety gloves to match your specific requirements.



<https://ces.uvex.de>

The breakthrough times were determined under laboratory conditions. As additional stresses, such as higher temperatures and mechanical influences, are often present in practice, this information serves as a guide only. Following contamination, wear or damage, the coverall is to be removed immediately and properly disposed of.

Disposable chemical protection

Guidelines for use

Tips for putting on and taking off



Instructions for putting on and taking off Type 3B (PDF)

Instructions for putting on



Instructions for taking off



Instructions for putting on and taking off Type 5/6 (PDF)

Instructions for putting on/
taking off



Information on selecting the correct size of disposable protective suit

To ensure an optimum fit and keep the wearer safe when working with hazardous substances, uvex disposable overalls are available in multiple sizes. However, the correct size may not be the same as your usual clothing size. Use the following overview to find the correct fit based on your height and chest circumference.

Body height in cm	Chest circumference in cm	Size to choose
164 - 170 cm	84 - 92 cm	S
170 - 176 cm	92 - 100 cm	M
176 - 182 cm	100 - 108 cm	L
182 - 188 cm	108 - 116 cm	XL
188 - 194 cm	116 - 124 cm	XXL
194 - 200 cm	124 - 132 cm	XXXL

Selecting the correct chemical-protection clothing

In order to select appropriate chemical-protection clothing for a specific application within your business, it is important to have your overalls tested by a trained safety officer. Many chemicals can cause serious or irreversible injury to workers if they are not adequately protected. For this reason, chemical-protection clothing should be selected with great care.

Note: It is the responsibility of the user to decide for themselves whether the protective suit used is suitable and correct for the intended use. uvex accepts no responsibility whatsoever in the event of improper use and application of these products.

Proper handling of uvex disposable protective clothing

Storage

uvex disposable protective clothing must be stored in its original packaging, away from light and in a dry environment at temperatures of 15°C–25°C. The products must be disposed of after use in accordance with the respective legal requirements.

Washing disposable protective suits

Disposable overalls are for single use only and must not be washed.

Durability

It is recommended to use the product within five years from the production date, which can be found on the label.

Download - PDF, 2,2 MB



uvex-safety.com/en/overalls



Safety Gloves

Product system planet series › Safety Gloves

uvex has developed the **protecting planet** icon, to help raise awareness of its commitment to achieving increased sustainability. Based on the brand claim, **protecting people**, our sustainable approach integrates three core interlinked pillars – **ecology, economy** and **social responsibility**, that are incorporated throughout the business to improve our sustainability performance.

This explains the comprehensive audit, measurement and evaluation management process uvex undertakes along the entire value chain to ensure its products are as sustainable as possible.

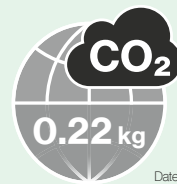

Date created 01/2023*

uvex phynomic XG planet

MADE IN GERMANY

protecting planet
by using recycled material //
by maximum reduction of pollutants

Polyamide recycle
› more than 50 percent based on polyamide waste from the fibre manufacturer (polyamide recycle)

Health
› skin compatibility dermatologically approved by the proDerm Institute
› exceeds REACH regulations

protecting planet
by using environmentally-friendly packaging

Packaging
› minimisation of packaging (only outer carton and sleeve)
› 80 percent paper sleeve made of FSC-certified kraft paper
› no polyester bags

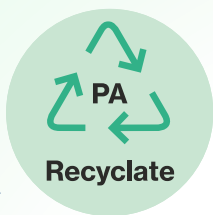

Polyamide recyclate

>50%

CO₂ emissions

-29%

by using polyamide recyclate



60070

Packaging

100%

made of paper and cardboard



protecting planet

by having a CO₂ neutral production

Certifications

- › Environmental management ISO 14001
- › Energy management ISO 50001

Production

- › CO₂ neutral, based on emissions resulting directly from production. Using electricity from 100 percent renewable energy sources since 2014.
- › promoting the construction of new plants for renewable energies in the region.

Offsetting

- › operating the highly efficient CHP at our site using green gas
- › offsetting the resulting CO₂ emissions
- › investing exclusively in approved certified climate protection projects (Gold Standard or VCS – Verified Carbon Standard)
- › promoting, for example, the construction of new plants in India for the generation of solar and wind power

The uvex brand is our responsibility

uvex safety gloves is certified according to both **Environmental Management ISO 14001** and **Energy Management ISO 50001** and has **CO₂-neutral production rating** based on direct emissions from production.

Production in Germany ensures **sustainable, resource-saving production** and short distances from manufacturer to end user.

uvex hand protection

To meet our obligations, we have been using **electricity from 100 percent renewable energy sources** since 2014. With this certified **green electricity** product, we promote the construction of new plants for renewable energies in the region. We use **green gas** to **operate the highly efficient combined heat and power plant** at our site, thereby offsetting the CO₂ emissions produced by gas combustion processes. Through **carbon offsetting**, we invest exclusively in **climate protection projects** that are certified by internationally recognised quality standards (Gold Standard or VCS – Verified Carbon Standard) and thereby promote, for example, the construction of new plants in India for the generation of solar and wind power.

Material

- focus on bio-based materials: cotton, bamboo viscose, HPPE (bio-based) and/or polyamide made from recycled raw materials
- use of accelerator-free NBR coatings
- extremely comfortable and natural fit thanks to the use of breathable natural and functional fibres

Health

- exceeds REACH regulations on eliminating harmful substances
- ongoing analysis of almost 200 critical substances (uvex harmful substances standard)
- certified in line with Oeko-Tex® Standard 100
- DERMA-certified free from allergenic substances

Product information/packaging

- instructions for use on FSC-certified paper (as soon as legally possible via QR code)
- minimisation/optimisation of packaging (outer carton and sleeve)
- paper sleeve made of 80 percent FSC-certified kraft paper
- carton adhesive tape: Wet adhesive tape with starch-based adhesive made from potatoes

Social responsibility

- full implementation of the ILO standard
- continuous social audits at partner companies (uvex social standard)
- social engagement with a focus on disadvantaged children

Green electricity

100%

comes from renewable energy sources



Amount of waste in glove production reduced by

22.7%

between 2019/2020 and 2021/2022

CO₂-neutral production

100%

in Lueneburg, Germany

Innovative safety gloves “Made in Germany”

Manufacturing and technology expertise



uvex hand protection centre of expertise in Lüneburg

A fully integrated development process, state-of-the-art robot-controlled plant technology and strict production controls guarantee that our safety gloves are of first-class quality. Production in Germany ensures sustainable, resource-saving production and short distances from manufacturer to end user.



We know exactly what you want.

Our expertise is available for you at all times which forms the basis of our on-site. Risk-hazard analysis service: Our hand protection specialists work with you to determine which safety gloves are best suited to your individual requirements. Seminars, laboratory analyses and online tools round off our service portfolio.



Video

MADE IN GERMANY 

Fully integrated development processes

- own yarn/liner manufacturing
- own compounding (blending)
- specially developed moulding and process technology
- innovative coating technology
- development of customer-specific solutions
- technical modifications to existing products (e.g. thermal lining)
- individual production (e.g. gloves for disabled people)

Extensive know-how is part of our service
Service expertise



Quality management



Energy management



Environmental management



Consultation / training / application technology

- on-site consultation from uvex product specialists
- practical hand protection seminars (uvex academy)
- plant and laboratory tours for customers
- cooperation with scientific institutes
- measurement and analysis service in own laboratories
 - mechanical standard test in accordance with EN 388
 - permeation tests in accordance with EN 374
 - special tests (e.g. antistatic/grip measurement/climate test)
- individual certifications (e.g. for ingredients, coating compatibility, food product suitability)

Information / e-services

- uvex glove expert
- designer glove plan
- online glove navigator
- online product data sheets
- online declaration of conformity

For further information, please visit:
www.uvex-safety.de/usgfilm

Safety Gloves

Mechanical Risks / Special risks



Precision work

uvex phynomic



Page 214	Page 215	Page 215	Page 215	Page 216	Page 216	Page 216	Page 217	Page 217	Page 218	Page 218
uvex phynomic XG planet	uvex phynomic airLite A ESD	uvex phynomic foam	uvex phynomic allround	uvex phynomic x-foam HV	uvex phynomic wet	uvex phynomic wet plus	uvex phynomic pro	uvex phynomic pro 2	uvex phynomic lite	uvex phynomic lite w

uvex rubipor



Page 218	uvex glove clip	Page 219	uvex rubipor XS	Page 219	uvex rubipor XS
----------	-----------------	----------	-----------------	----------	-----------------

uvex athletic



Page 219	Page 220	Page 220	Page 220
uvex athletic allround	uvex athletic lite	uvex athletic lite ESD	uvex athletic lite dry

uvex unilite



Page 221	Page 221
uvex unilite 6605	uvex unilite 7700

uvex unipur



Page 221	Page 222	Page 222	Page 222	Page 222	Page 223	Page 223
uvex unipur 6634	uvex unipur 6630	uvex unipur 6631	uvex unipur 6639	uvex unipur carbon	uvex unipur carbon FT	

uvex unigrip



Page 223	Page 223
uvex unigrip 6624	uvex unigrip 6620



Allround

uvex profi



Page 224	Page 225	Page 225	Page 226	Page 226	Page 226
uvex profi pure HG	uvex profi ergo XG20A	uvex profi ergo XG20	uvex profi ergo ENB20A	uvex profi ergo ENB20	uvex contact ergo ENB20C



Heavy Duty



Page 227	Page 227	Page 227	Page 227
uvex rubiflex	uvex unilite 7710 F	uvex compact NB27E	uvex compact NB27H



Heat protection



Page 228	Page 228	Page 228
uvex nk	uvex k-basic extra	uvex profatherm



Cold protection

uvex unilite thermo



Page 229	Page 229	Page 229	Page 229
uvex unilite thermo	uvex unilite thermo plus	uvex unilite thermo FC	uvex unilite thermo plus cut c



Working on live parts



Page 230	Page 230
uvex power protect V1000	uvex arc protect g1

Safety Gloves

Cut protection

uvex D500 / uvex C500										uvex C300		
Page 235	Page 236	Page 236	Page 237	Page 237	Page 237	Page 237	Page 238	Page 238	Page 238	Page 239	Page 239	Page 239
uvex Bamboo Twinflex® D xg	uvex D500 foam	uvex C500 M foam	uvex C500 sleeve	uvex C500	uvex C500 wet plus	uvex C500 XG	uvex C500 dry	uvex C500 foam	uvex C500 wet	uvex C300 dry	uvex C300 foam	uvex C300 wet

Cut protection

uvex phynomic						uvex athletic			uvex unidur						
Page 240	Page 241	Page 241	Page 242	Page 243	Page 243	Page 244	Page 245	Page 245	Page 246	Page 246	Page 246	Page 247	Page 247	Page 247	Page 247
uvex phynomic F XG	uvex phynomic B foam	uvex phynomic B XG	uvex phynomic C5	uvex phynomic C XG	uvex phynomic C XG ESD	uvex athletic B XP	uvex athletic C XP	uvex athletic D5 XP	uvex unidur 6641	uvex unidur 6648	uvex unidur 6649	uvex unidur 6643	uvex unidur 6659 foam	uvex unidur sleeve C	uvex unidur sleeve C TL

Chemical Risks

Safety gloves with textil support - Coating: Nitrile

uvex rubiflex						uvex u-chem			uvex protector	
Page 251	Page 251	Page 252	Page 252	Page 252	Page 254	Page 256	Page 257	Page 256	Page 253	Page 253
uvex rubiflex S XG	uvex rubiflex S	uvex rubiflex S	uvex rubiflex SZ	uvex rubiflex SZ	uvex rubiflex ESD	uvex u-chem 3300	uvex u-chem 3100	uvex u-chem 3500	uvex protector chemical	uvex protector chemical



Safety gloves without textil support Disposable safety gloves

uvex u-fit				HexArmor gloves				
Page 255	Page 255	Page 257	Page 257	Page 259	Page 259	Page 259	Page 259	
uvex profabutyl B-05R	uvex profaviton BV-06	uvex profastrong NF33	uvex profapren CF33	uvex u-fit strong N2000	uvex u-fit	uvex u-fit ft	uvex u-fit lite	

Table of contents

Standards and product advice

International standards for safety gloves

International standards for safety gloves		Page
DIN EN 388:2016-03	Safety gloves to protect against mechanical risks	208
DIN EN ISO 374-1:2018-10	Safety gloves to protect against dangerous chemicals and micro-organisms	209
DIN EN 16350:2014-07	Safety gloves to protect against electrostatic characteristics	211
DIN EN 60903:2003	Live working - Gloves of insulating material	211
DIN EN 61482-1-2:2015-08	Working with high voltage - Clothing that protects against the thermal hazards of an electric arc – part 1-2	211
DIN EN 407:2020-06	Safety gloves and other protective hand equipment designed to protect against thermal risks (heat and/or fire)	210
DIN EN 511:2006-07	Safety gloves to protect against the cold	210
	Suitable for use with foods (glove materials)	208
ISO 18889	Crop protection	211

We help you choose the right safety gloves for your needs

Discover all our helpful services on our website		Page
1	uvex Glove Navigator - The fast route to finding the right gloves for you	249
2	uvex glove expert - Chemicals database, permeation lists - uvex glove plan designer	248

uvex – consultation and product expertise from a single source

These pictograms in our catalogue help you to choose the perfect safety glove.

1. Select the risk potential

What is the main risk for users in the workplace?



2. Determine your individual requirements

What type of activity are the safety gloves being selected for?

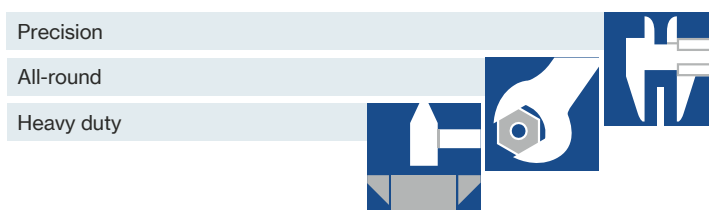

3. Defining environmental conditions

Are the activities in wet/oily or more humid or dry working environments?

The bars indicate how suitable the product is for each setting.

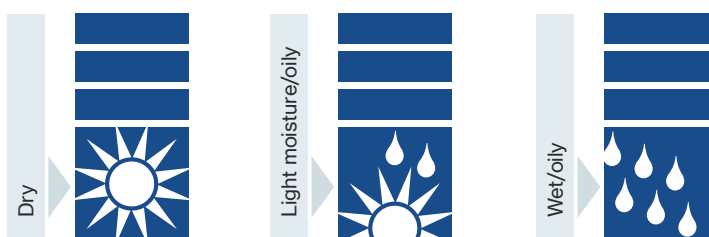

<p>STANDARD 100 502-0648 Hohenstein HTTI</p>	<p>MADE IN GERMANY </p>	<p>clima zone</p>
<p>Textiles tested for pollutants</p>	<p>Produced in Germany</p>	<p>Breathability for high wearer comfort</p>
<p>Dermatologically tested for skin compatibility</p>	<p>Can be used with touchscreens</p>	<p>Bamboo TwinFlex® technology for safety (cut protection) and comfort (bamboo fibre)</p>

Detailed information on the award criteria of the certificate issuers can be found at: uvex-safety.com/certificates

Standards

EN 388:2016+A1:2018

Standard for safety gloves to protect against mechanical risks

EN 388:2016 contains various test methods for comparing the mechanical performance of gloves. This standard focusses on the following six performance levels:

EN 388:2016

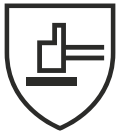

4 X 3 2 D P

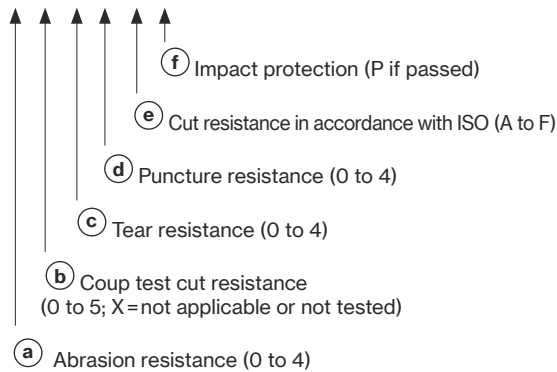

Video



- (a) **Abrasion resistance**
To test the abrasion resistance of the safety glove, the material is rubbed with abrasive paper under pressure. The number of cycles required to grind a hole into the material is used as a reference value. (Highest performance class 4 = 8000 cycles)
- (b) **Cut resistance by means of the coupe test**
A rotating circular knife is used to test the cut resistance of a safety glove. The knife cuts through the glove material at constant speed and constant force. The reference value is the comparison with a reference material and a resulting index. (Highest performance class 5 = index 20)
- (c) **Tear resistance**
To test the tear resistance of the safety glove, the material is first cut. The reference value is the force required to tear the material. (Highest performance class 4 = 75 newtons)
- (d) **Puncture resistance**
To test the puncture resistance, the material to be tested is pierced with a nail (defined dimension). The force used for this is used as a reference value.
- (e) **Cut resistance according to TDM**
The application of the test method in accordance with ISO 13997 is relevant for materials that blunt the rotating circular knife during the coupe test (see above). The required force for cutting a material is measured at a defined distance (20 mm) (highest performance class F= 30 newton)
- (f) **Additional impact protection**
Gloves with performance class "P" at the end offer specific impact absorption.

Suitability grades

Safety gloves for working with food must be designed in such a way that absolutely no components can be transferred to food which may

pose a hazard to human health (migration) under normal and predictable conditions.



Area of application	Aqueous pH > 4.5	Acidic pH < 4.5	Alcoholic	Fatty	Dry, non fatty
Examples	Non-alcoholic beverages Fruit Eggs Vegetables Crustaceans	Vinegar Yeast Milk Yoghurt	Wine Spirits Liqueurs	R1 = olive oil R2 = butter, margarine R3 = fish, cheese, baked goods R4 = meat, poultry R5 = sandwiches, fried food	Bread Pasta Rice Tea Spices Pulses
uvex Bamboo TwinFlex® D xg	YES	YES	YES	YES (R1 – R5)	YES
uvex phynomic airlite A ESD	YES	YES	YES	YES (R1 – R5)	YES
uvex profi ergo/ uvex contact ergo	YES	YES	YES	YES (R1 – R5)	YES
uvex phynomic B foam/ uvex phynomic C5	YES	YES	YES	YES (R1 – R5)	YES
uvex rubiflex und uvex rubiflex S	YES	YES	YES	YES (R1 – R5)	YES
uvex profastrong NF 33	YES	YES	YES	YES (R2 – R5)	YES
uvex u-fit	YES	YES	YES	YES (R3 – R5)	YES
uvex phynomic foam	YES	YES	YES	YES (R5)	YES
uvex phynomic lite (w)	YES	YES	YES	YES (R1 – R5)	YES
uvex unilite thermo	YES	YES	YES	NO	YES
uvex u-fit strong N2000	YES	NO	YES	YES (R3 – R5)	YES
uvex u-fit lite	YES	NO	YES	YES (R3 – R5)	YES
uvex u-chem 3300	YES	YES	YES	YES (R2 – R5)	YES
uvex phynomic F XG	YES	YES	YES	YES	YES

EN ISO 374-1:2018 Standard for safety gloves to protect against chemical risks

Chemical safety gloves must meet the requirements of European standard EN ISO 374-1. This standard has undergone fundamental changes in terms of certification.

Test chemicals: From the list of 18 test chemicals, the glove material must be tested for permeation as part of the certification process using 6, 3 or 1 chemical(s), depending on the type class.

Identifier	Test chemical	Group	Class
A	Methanol	polar*	Primary alcohol
B	Acetone		Ketone
C	Acetonitrile		Nitrile
G	Diethylamine		Amine
H	Tetrahydrofuran		Heterocyclic, ether compounds
I	Ethyl acetate		Ester
T	Formaldehyde 37%		Aldehyde
E	Carbon disulphide		Sulphur-containing organic compound
J	n-heptane	aliphatic*	
F	Toluene	aromatic*	
D	Dichloromethane	halogenated*	Chlorinated
L	Sulphuric acid 96%	Acids	Inorganic acid, oxidising
M	Nitric acid 65%		Inorganic acid, oxidising
N	Acetic acid 99%		Organic acid
S	Hydrofluoric acid 40%		Inorganic acid
K	Sodium hydroxide 40%	Bases (alkalis)	Inorganic base
O	Ammonia water 25%		Organic base
P	Hydrogen peroxide 30%	Peroxide (bleach)	Peroxide

* Solvents (hydrocarbons (KWS))

Labelling of safety gloves

EN ISO 374-1:2016/Type A



J K L M N O

Permeation resistance of type A:
at least 30 minutes each with at least 6 test chemicals.

EN ISO 374-1:2016/Type B



J K L

Permeation resistance of type B:
at least 30 minutes each with at least 3 test chemicals.

EN ISO 374-1:2016/Type C



Permeation resistance of type C:
at least 10 minutes each with at least 1 test chemical.

With the uvex Chemical Expert System, uvex provides a multilingual, online platform to search for individual permeation times. In addition, experienced staff are available on-site and in the centre of expertise for safety gloves in Lüneburg to provide advice on all questions relating to safety gloves for protection against chemical risks.

Your uvex account manager will be happy to provide advice.

DIN EN 374-5: 2016 Standard for safety gloves to protect against dangerous chemicals and micro-organisms

To protect against microorganisms such as bacteria, fungi and viruses, safety gloves must undergo and pass special penetration tests in accordance with ISO 16604:2004 (method B). Only then may they be marked with the pictogram for EN ISO 374-5.

Labelling of safety gloves

EN ISO 374-5:2016



Virus

Variant 1:
Protects against bacteria, fungi and viruses

EN ISO 374-5:2016



Variant 2:
Protects against bacteria and fungi

Labelling on the glove



- 1 Name of the manufacturer
- 2 Glove Product Name
- 3 Performance classes, mechanical
- 4 CE conformity mark
- 5 No. of Test Institute
- 6 Letters symbolise test chemicals against which the glove has a protection index of at least class 2.
- 7 Pictogram with designation of standard
- 8 Note enclosed instructions for use
- 9 Glove size
- 10 Expiration date
- 11 Manufacturer address



Permeation

Time measured to penetration	Protection index
> 10 min	Class 1
> 30 min	Class 2
> 60 min	Class 3
> 120 min	Class 4
> 240 min	Class 5
> 480 min	Class 6

Permeation refers to molecular penetration through the safety glove material. The time required by the chemicals to permeate, determines the performance class in accordance with EN ISO 374-1.

The actual period of protection at the workplace may vary depending on real-time process factors.

Standards

EN 407:2020 • DIN EN 511:2016

DIN EN 407:2020 Standard for safety gloves providing protection against thermal risks – heat

The European **standard DIN EN 407** regulates the requirements for safety gloves that provide protection against thermal risks in applications involving heat. Safety gloves certified according to this standard protect the wearer against contact heat, radiant heat and small splashes of molten metal, for example.

However, this does not apply to the specific use of safety gloves in firefighting. According to DIN EN 407, heat protection gloves must have the following features:

- low flammability and low flame propagation
- low heat transmission (protection against radiant, convective and contact heat)
- high temperature resistance

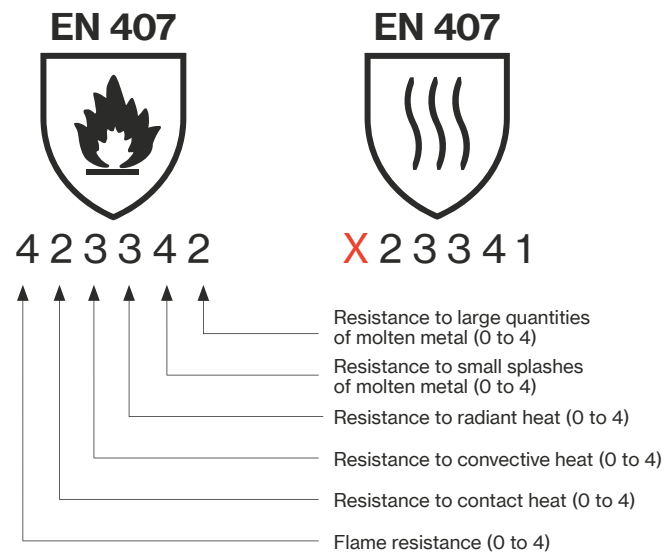

Important changes to standards!

In the latest version of DIN EN 407: As of 2020, the first performance class is no longer named “resistance to flammability”, but is now called “limited flame spread”. If the glove has not been tested for this, a new pictogram is used (see above right). However, there are no changes to the performance classes.

The test described in DIN EN 407 assigns safety gloves a performance class in relation to each of the individual thermal hazards. It is important that the glove does not come into contact with open flames if it does not meet the criteria of performance class 3 in the limited flame spread test.

DIN EN 511:2006 Standard for safety gloves providing protection against thermal risks – cold

Cold safety gloves must meet the requirements of the European **standard DIN EN 511**. The certified gloves below are designed to protect the wearer from penetrating ambient cold and from contact cold through direct contact.

Gloves can also be tested for water impermeability in accordance with EN ISO 15383, thus enabling them to protect the hands from wetness and moisture. This test is considered to have been passed if water does not penetrate the safety glove over a 30-minute period.

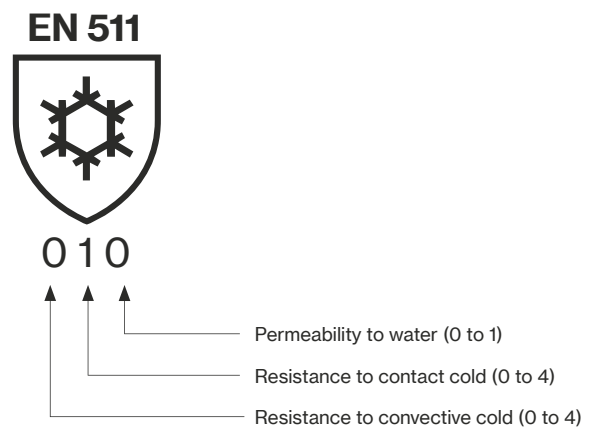

As with mechanical risk protection, the safety glove is assigned a different performance class for each individual aspect. The performance classes are indicated by a number from 0 to 4 next to the pictogram, whereby 4 is the highest performance class.



DIN EN 16350:2014 Safety gloves – Electrostatic characteristics

The new standard

Choosing the right personal protective equipment (PPE) is particularly important in working environments that are hazardous or harbour health risks. For workplaces at risk of fire and explosive atmospheres, “EN 16350:2014 – Protective gloves – electrostatic properties” is the first European standard to prescribe the test conditions and minimum requirements for electrostatic properties of safety gloves.

- ▶ vertical resistance must be less than $1.0 \times 10^8 \Omega$ ($R_v < 1.0 \times 10^8 \Omega$).
- ▶ test atmosphere: ambient temperature of $23 \pm 1 \text{ }^\circ\text{C}$, relative humidity of $25 \pm 5\%$.

Important notice:

Electrostatic discharge safety gloves are only effective if the wearer is grounded with resistance of less than $10^8 \Omega$.

What should users take into account?

EN 16350:2014 is the first standard to define a limit value for vertical resistance for protective gloves; this value was not included in DIN EN 1149.

Users must therefore check the suitability of the protective gloves in line with EN 16350:2014.

References to EN 1149 are no longer sufficient, as this standard only describes the testing procedure and does not specify a limit value.

ISO 18889 Standard for safety gloves for users of crop protection products

The EN 18889 standard consists of three performance levels – GR, G1 and G2. G2 offers the highest level of protection.



GR: Partially coated safety gloves provide protection against dried spray coatings during follow-up work.



G1: Fully coated safety gloves for handling ready-to-use crop protection products.



G2: Fully coated safety gloves for use with concentrated crop protection products.

DIN EN 60903:2003 Live working – Gloves made from insulating material

DIN EN 60903-compliant safety gloves are category iii PPE. The insulation protection class of the insulating personal protective equipment (PPE) is determined according to the nominal voltage of the plant, with both the maximum permissible nominal AC voltage (AC) and the nominal DC voltage (DC) being calculated.

Labelling of safety gloves

DIN EN 60903



Class 0

Insulation protection class	Max. permissible nominal AC voltage (AC)	Max. permissible nominal direct voltage (DC)
00	500 volts	750 volts
0	1,000 volts	1,500 volts
1	7,500 volts	11,250 volts
2	17,000 volts	25,000 volts
3	26,500 volts	39,750 volts
4	36,000 volts	54,000 volts

Additional identifier

Category	Resistant to
A	Acids
H	Oil
Z	Ozone
C	Extremely low temperatures

DIN EN 61482-1-2:2015-08 Live working - Protective clothing against the thermal hazards of an electric arc

Part 1-2: Test methods – Method 2:

Determining the arc protection class of the material and the clothing using a directed test arc (box test)

Hands are at the greatest risk of burns from short circuit electric arcs when working on electrical equipment. Unfortunately, there is no recognised standard for safety gloves in Germany for testing the potential dangers of a short circuit electric arc. Therefore, safety gloves for protection against the thermal discharge of a short circuit electric arc are generally tested in accordance with EN 61482-1-2 and classified accordingly.

Class	Test current [kA]	Arcing time [ms]	Arc energy [kJ]	Incident energy [kJ/m²]
1	4	500	168 +/- 17	146 +/- 28
2	7	500	320 +/- 22	427 +/- 39



More on this topic



Mechanical Risks

Area of application: precision/all-round

	 Precision	 All-round	 Heavy duty
	Activities where a high level of sensitivity is necessary.	General, multiple activities for which robust, stable safety gloves are required.	Tough activities requiring highly robust, abrasion resistant safety gloves.
	Examples: fine assembly work, working with small parts (e.g. screws), operating controls, end inspection.	Examples: servicing, transport work, light metal processing, standard assembly work, maintenance.	Examples: heavy transport work (e. g. palette transport), construction, servicing.
 dry	    uvex phynomic airLite A ESD uvex phynomic lite/lite w uvex unipur Serie uvex rubipor Serie	 uvex phynomic foam	
 light moisture / oily		    uvex athletic lite ESD uvex athletic lite uvex phynomic allround uvex athletic lite dry	 uvex unilite thermo
 wet / oily		    uvex phynomic wet uvex phynomic wet plus uvex phynomic XG uvex phynomic pro 2	  uvex phynomic pro uvex unilite thermo plus c
		    uvex contact ergo uvex profi ergo uvex rubiflex NB27 uvex 7710 F	    uvex profi XG uvex profi pure HG uvex compact uvex unilite thermo FC



Working areas which do not have any moisture (water, oil, fat, cooling lubricant, etc.). Safety gloves for these conditions are extremely breathable. Examples: quality control, assembly work, distribution, end processing.



Working areas with some moisture. Safety gloves for these conditions are less breathable. The water/oil-repelling coating is crucial and also guarantees slip-resistance. Examples: oil-coated parts, changing between dry and damp working environments.



Working areas in which hands should be protected from liquids (not chemicals). Sealed safety gloves with high slip-resistance are necessary. Examples: removing oily/wet parts from machines, outdoor activities (weather-related humidity).

uvex phynomic

Perfection in 3 dimensions

1. Perfect fit



3D ergo technology – precision all the way to the fingertips

- Ergonomic solution for every wearer: up to 8 perfectly coordinated sizes
- The advantages for the wearer:
 - the glove fits like a second skin
 - natural touch
 - maximum flexibility for fatigue-free work

2. Optimum functionality



Coatings perfectly adapted to the application at hand

- for dry areas: aqua-polymer waterproofing
- for dry and slightly damp areas: aqua-polymer foam coating
- for humid and oily areas: aqua-polymer xtra grip foam coating
- for wet and oily areas: aqua-polymer pro coating
- for applications with industrial touchscreen monitors: airLite aqua-polymer foam coating***

3. Skin safe – product safe



Enhanced skin care and product protection

- Health protection
- no skin irritation
 - dermatologically approved*
 - certified in accordance with OEKO-TEX® Standard 100
 - free from harmful solvents (DMF, TEA)
 - free from allergenic substances
- Product protection
- silicone-free according to imprint test
 - suitable for sensitive surfaces
 - does not leave any traces/marks
 - certified for food processes**



clima zone

MADE IN GERMANY 



* The uvex phynomic series was clinically tested by the proDERM® Institute for Applied Dermatological Research (Hamburg, Germany). The extremely good skin tolerability of uvex phynomic safety gloves has been dermatologically tested (proDERM® studies: 11.0356-02, 11.0482-11, 13.0202-02, 15.0188-02, 15.0219-11). Detailed information on the award criteria applied by the certification bodies OEKO-TEX® and proDERM can be found at: uvex-safety.com/certificates

** Models uvex phynomic lite/lite w, uvex phynomic foam, uvex phynomic B foam and phynomic C5

*** Models uvex phynomic airLite A ESD, uvex phynomic airLite B ESD, uvex phynomic airLite C ESD



protecting planet

The logical addition to the successful uvex phynomic XG model

The uvex phynomic XG with Xtra Grip coating is known for its excellent grip in oily conditions. But it performs just as well in dry applications. It is manufactured at our CO₂-neutral site in Germany and, like all of our products that are "Made in Germany", contributes towards greater sustainability today.

 **protecting planet**
by using recycled material//
by maximum reduction of pollutants

Now we are increasing our contribution to sustainability once again:
The polyamide in our textiles, comprising > 50% of the total weight, will be replaced with recycled polyamide. This allows us to conserve our environmental resources, while also reducing our carbon footprint.



We've also equipped the glove with an additional touchscreen function, so there's no need for you to take it off.



60070

EN 388:2016
4121X

Xtra Grip

MADE IN GERMANY



uvex phynomic XG planet

- flexible and extremely durable assembly glove with the best oil grip in its class
- outstanding mechanical abrasion resistance thanks to the aqua-polymer Xtra Grip coating
- outstanding grip in oily areas
- high level of breathability due to the porous foam coating
- very good tactile feel when assembling (oily) parts
- free from accelerators for health protection and skin compatibility dermatologically approved (proDERM®), highly suitable for allergy sufferers
- certified according to OEKO-TEX® Standard 100 (S02-0648 HOHENSTEIN HTTI)

	uvex phynomic XG
Art. no.	60070
Design	knitted cuff
Standard	EN 388 (4 12 1 X)
Material	elastane, carbon
Coating	aqua-polymer xtra grip foam coating on palm and fingertips
Suitable for	damp and oily working conditions
Colour	black, black
Sizes	5 to 12
Order unit	10 PR



Mechanical Risks

Area of application: precision/all-round



60038



60050



60049



uvex phynomic airLite A ESD

- the lightest safety glove in its class
- ESD function (DIN EN 16350:2014)
- a noticeable difference in wearer comfort: combination of high sensitivity and tactile feel, lightness and breathability
- touchscreen compatibility for use on almost all screens, tablets and mobile phones
- thin and breathable "airLite" aqua-polymer coating combines the highest sensitivity and tactile feel with touchscreen compatibility
- very good grip in dry and slightly damp areas
- free from accelerators, health protection and skin compatibility dermatologically approved (proDERM®), highly suitable for allergy sufferers
- certified according to OEKO-TEX® Standard 100 (S02-0648 HOHENSTEIN HTTI)

uvex phynomic foam

- dexterity safety glove for precision mechanical work
- very good mechanical abrasion resistance thanks to the damp-resistant aqua-polymer foam coating
- good grip in dry and slightly damp areas
- highly breathable coating
- outstanding tactile feel when assembling parts
- free from accelerators, health protection and skin compatibility dermatologically approved (proDERM®), highly suitable for allergy sufferers
- certified according to OEKO-TEX® Standard 100 (S02-0648 HOHENSTEIN HTTI)

uvex phynomic allround

- light and dirt-resistant all-round safety glove for mechanical activities
- very good mechanical abrasion resistance thanks to the damp-resistant aqua-polymer foam coating
- good grip in dry and slightly damp areas
- highly breathable coating
- outstanding tactile feel when assembling parts
- free from accelerators, health protection and skin compatibility dermatologically approved (proDERM®), highly suitable for allergy sufferers
- certified according to OEKO-TEX® Standard 100 (S02-0648 HOHENSTEIN HTTI)



Art. no.	uvex phynomic airLite A ESD 60038
Design	knitted cuff
Standard	EN 388 (3 11 0 X), EN 16350
Material	polyamide, elastane, carbon
Coating	palm and fingertips with airLite aqua-polymer coating
Suitable for	for dry and slightly damp areas of application
Colour	black
Sizes	5 to 12
Order quantity multiples	10 PR

Art. no.	uvex phynomic foam 60050
Design	knitted cuff
Standard	EN 388 (3 1 2 1 X)
Material	polyamide, elastane
Coating	palm and fingertips with aqua-polymer foam coating
Suitable for	dry areas and slightly damp areas
Colour	white, grey
Sizes	5 to 12
Order unit	10 PR

Art. no.	uvex phynomic allround 60049
Design	knitted cuff
Standard	EN 388 (3 1 2 1 X)
Material	polyamide, elastane
Coating	palm and fingertips with aqua-polymer foam coating
Suitable for	dry areas and slightly damp areas
Colour	grey, black
Sizes	5 to 12
Order unit	10 PR



You can find more information at www.uvex-safety.com/airlite



Mechanical Risks

Area of application: precision/all-round

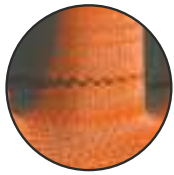

Break section



60054



MADE IN GERMANY



60060



MADE IN GERMANY



60061



uvex phynomic x-foam HV

- unique safety glove with break sections
- reduced tear resistance in the finger area with the integration of a seamless break section, which clearly reduces the risk of severe hand injuries when using hand-held power tools
- very good mechanical abrasion resistance thanks to the damp-resistant aqua-polymer foam coating
- good grip in dry and slightly damp areas
- highly breathable coating
- outstanding tactile feel when assembling parts

- free from accelerators, health protection and skin compatibility dermatologically approved (pro-DERM®), highly suitable for allergy sufferers
- certified according to OEKO-TEX® Standard 100 (S02-0648 HOHENSTEIN HTTI)

NOTE:

- only partially suitable for handling moving machine parts
- a thorough hazard analysis with the support of our uvex hand protection specialists is vital before use

uvex phynomic wet · uvex phynomic wet plus

- safety glove with water-repellent aqua-polymer foam coating for use in outdoor areas
- outstanding mechanical abrasion resistance thanks to the durable coating
- very good grip in damp and wet areas
- high level of breathability due to the coating

- very good tactile feel when assembling parts
- free from accelerators, health protection and skin compatibility dermatologically approved (pro-DERM®), highly suitable for allergy sufferers
- certified according to OEKO-TEX® Standard 100 (S02-0648 HOHENSTEIN HTTI)

Art. no.	uvex phynomic x-foam HV 60054
Design	knitted cuff
Standard	EN 388 (3 1 X 1 X)
Material	polyamide, elastane
Coating	palm and fingertips with aqua-polymer foam coating
Suitable for	dry areas and slightly damp areas
Colour	orange, grey
Sizes	6 to 12
Order quantity multiples	10 PR

Art. no.	uvex phynomic wet 60060	uvex phynomic wet plus 60061
Design	knitted cuff	knitted cuff
Standard	EN 388 (3 1 3 1 X)	EN 388 (3 1 3 1 X)
Material	polyamide, elastane	polyamide, elastane
Coating	palm and fingertips with aqua-polymer foam coating	palm and 3/4 of the back of the hand with aqua-polymer foam coating
Suitable for	damp and oily working conditions	damp and oily working conditions
Colour	blue, anthracite	blue, anthracite
Sizes	6 to 12	6 to 12
Order quantity multiples	10 PR	10 PR



Mechanical Risks

Area of application: precision/all-round/heavy duty

uvex phynomic pro: comfort made by uvex

In addition to protective function, safety gloves for assembly work must meet a variety of other demands placed on them by the wearer. These include dexterity, a comfortable internal temperature, flexibility and a slip-resistant coating, of which all ensure the gloves do not hinder work.

These requirements are met by a number of safety gloves currently available on the market. However, the workplace often involves a combination of activities, when wearers still need to have an excellent sense of touch even if there is a significant amount of dirt or moisture. If open cell coatings continue to be used in these environments, the hands become dirty, wet or oily as well as reduced product life and regular replacement rates.

This is where uvex's new product concept comes into its own.

The coating: the innovative aqua-polymer-pro coating features dirt and moisture-repellent properties. The gloves are coated up to and including the knuckles. It remains completely flexible and offers exceptional dry and wet grip (in both wet and oily applications).

The liner: uvex has already set new standards in cut protection with the patented Bamboo-TwinFlex® technology. The uvex phynomic pro represents a further ground-breaking development in the Cut 1 segment.

The liner combines bamboo with polyamide/elastane. The dirt and moisture-repellent coating requires that it is particularly important that the fibre combination is absorbent and wicks moisture away from the skin. The silky feel of this fibre also feels pleasant on the skin.

Purity "Made in Germany": This product in the uvex phynomic range has also been tested by the proDERM® Institute to confirm the skin compatibility and dermatological tolerance through a comprehensive process of repeated patch tests and in-use studies.



60064



60062



MADE IN GERMANY

uvex phynomic pro 2 · uvex phynomic pro

- high dexterity and dirt- and damp-resistant safety glove
- good mechanical abrasion resistance thanks to the durable aqua-polymer Pro coating
- very good grip in damp, wet and oily areas
- High breathability and very good moisture absorption thanks to the bamboo viscose liner
- very good tactile feel when handling parts
- outstanding wearer comfort on the skin thanks to the bamboo-polyamide-elastane liner
- free from accelerators, health protection and skin compatibility dermatologically approved (proDERM®), highly suitable for allergy sufferers
- certified according to OEKO-TEX® Standard 100 (S02-0648 HOHENSTEIN HTTI)



	uvex phynomic pro 2	uvex phynomic pro
Art. no.	60064	60062
Design	knitted cuff	knitted cuff
Standard	EN 388 (2 1 2 1 X)	EN 388 (2 1 2 1 X)
Material	bamboo, polyamide, elastane	bamboo, polyamide, elastane
Coating	palm and fingertips with aqua-polymer foam coating	palm and 3/4 of the back of the hand with aqua-polymer pro coating
Suitable for	damp and oily working conditions	damp and oily working conditions
Colour	blue, anthracite	blue, anthracite
Sizes	5 to 12	6 to 12
Order quantity multiples	10 PR	10 PR



Mechanical Risks

Area of application: precision/all-round



60040



60041



6047900

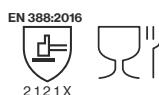
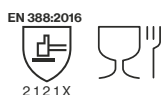

MADE IN GERMANY

uvex phynomic lite · uvex phynomic lite w

- lightweight safety glove for fatigue-free work
- good mechanical abrasion resistance thanks to the very thin but highly durable aqua-polymer impregnation
- good grip in dry and slightly damp areas
- very high level of breathability with the porous coating, which reduces sweating
- outstanding tactile feel when handling small parts
- free from accelerators, dermatologically approved skin compatibility (proDERM®), highly suitable for allergy sufferers

- certified according to OEKO-TEX® Standard 100 (S02-0648 HOHENSTEIN HTTI)

	uvex phynomic lite	uvex phynomic lite w
Art. no.	60040	60041
Design	knitted cuff	knitted cuff
Standard	EN 388 (2 1 2 1 X)	EN 388 (2 1 2 1 X)
Material	polyamide, elastane	polyamide, elastane
Coating	palm and fingertips with aqua-polymer impregnation	palm and fingertips with aqua-polymer impregnation
Suitable for	dry and slightly damp areas of application	dry and slightly damp areas of application
Colour	grey, grey	white, white
Sizes	5 to 12	5 to 12
Order quantity multiples	10 PR	10 PR

uvex glove clip

- universal fastening options due to snap hooks
- easy handling
- suitable for all gloves
- gloves are quickly fixed and released
- perfect hold due to jagged clamps
- uncomplicated attachment to work clothing

	uvex glove clip
Art. no.	6047900
Design	glove keeper with snap hook
Material	Polycarbonate
Coating	without
Suitable for	easy access to gloves
Colour	black
Order quantity multiples	10 PC



Mechanical Risks

Area of application: precision/all-round



60276



60316



MADE IN GERMANY



60028



uvex rubipor XS

- lightweight, elastic safety glove with stretch cotton material
- good grip in dry areas
- very high level of breathability with the thin layer of NBR impregnation
- very good tactile feel through the flexible stretch cotton material with elastane
- ergonomic fit

- certified according to OEKO-TEX® Standard 100 (S02-0648 HOHENSTEIN HTTI)

uvex athletic allround

- lightweight and dirt-resistant all-round safety glove for mechanical tasks
- very good mechanical abrasion resistance thanks to the damp-resistant aqua-polymer foam coating
- very good grip in dry and slightly damp areas
- perfect fit thanks to the "slim fit" design and elastane with liner
- certified according to OEKO-TEX® Standard 100 (S02-0648 HOHENSTEIN HTTI)



	uvex rubipor XS2001	uvex rubipor XS5001B
Art. no.	60276	60316
Design	knitted cuff	knitted cuff
Standard	EN 388 (1110 X)	EN 388 (1110 X)
Material	cotton interlock, elastane	cotton interlock, elastane
Coating	palm and fingertips coated with breathable	palm and fingertips coated with breathable
Suitable for	NBR special impregnation	NBR special impregnation
Colour	dry areas of application	dry areas of application
Sizes	white, white	white, blue
Order quantity multiples	6 to 10	6 to 10
	10 PR	10 PR

	uvex athletic allround
Art. no.	60028
Design	knitted cuff
Standard	EN 388 (4122 X)
Material	polyamide, elastane
Coating	palm and fingertips with NBR foam coating
Suitable for	dry and slightly damp areas
Colour	grey, anthracite
Sizes	6 to 11
Order quantity multiples	10 PR



Mechanical Risks

Area of application: precision/all-round



60027



60035

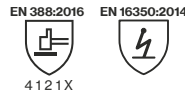

60033

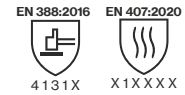

uvex athletic lite

- lightweight and sensitive safety glove for mechanical tasks
- matt, porous and particularly abrasion-resistant microfoam coating
- very good grip in dry and slightly damp areas
- high breathability thanks to the porous coating, reducing sweating
- perfect fit thanks to the “slim fit” design and elastane in the liner
- certified according to OEKO-TEX® Standard 100 (S02-0648 HOHENSTEIN HTTI)

	uvex athletic lite
Art. no.	60027
Design	knitted cuff
Standard	EN 388 (4 1 3 1 X)
Material	polyamide, elastane
Coating	palm and fingertips with NBR foam coating
Suitable for	dry and slightly damp areas
Colour	blue, anthracite
Sizes	6 to 12
Order quantity multiples	10 PR

uvex athletic lite ESD

- lightweight and sensitive safety glove for mechanical tasks, even a little thinner and with higher dexterity than the uvex athletic lite
- touchscreen ability and ESD function according to DIN EN 16350:2014
- matt, porous and particularly abrasion-resistant microfoam coating
- very good grip in dry and slightly damp areas
- high breathability thanks to the porous coating, reducing sweating
- perfect fit thanks to the “slim fit” design and elastane in the liner
- certified according to OEKO-TEX® Standard 100 (S02-0648 HOHENSTEIN HTTI)

	uvex athletic lite ESD
Art. no.	60035
Design	knitted cuff
Standard	EN 388 (4 1 2 1 X), DIN EN 16350:2014
Material	polyamide, elastane, carbon
Coating	palm and fingertips with NBR foam coating
Suitable for	dry and slightly damp areas
Colour	blue, anthracite
Sizes	6 to 11
Order quantity multiples	10 PR

uvex athletic lite dry

- lightweight and sensitive safety glove for mechanical tasks
- matt, porous and particularly abrasion-resistant microfoam coating
- with nubbing, for increased durability and a good grip
- sehr gute Griffssicherheit in trockenen und very good grip in dry and slightly damp areas
- high breathability thanks to the porous coating, reducing sweating
- perfect fit thanks to the “slim fit” design and elastane in the liner
- certified according to OEKO-TEX® Standard 100 (S02-0648 HOHENSTEIN HTTI)

	uvex athletic lite dry
Art. no.	60033
Design	knitted cuff
Standard	EN 388 (4 1 3 1 X), EN 407 (X 1 X X X X)
Material	polyamide, elastane
Coating	palm and fingertips with NBR foam coating, dots
Suitable for	dry and slightly damp areas
Colour	blue, anthracite
Sizes	6 to 12
Order quantity multiples	10 PR



Mechanical Risks

Area of application: precision/all-round



60573



60585



60321



uvex unilite 6605

- lightweight knitted glove with NBR foam coating for mechanical precision work
- good mechanical abrasion resistance with the polyamide liner and coating
- good grip in dry and slightly damp areas
- breathable
- good tactile feel
- good fit
- highly flexible

uvex unilite 7700

- flexible and durable safety glove for mechanical precision work
- good mechanical abrasion resistance with the polyamide-elastane liner and NBR polyurethane coating
- good grip in dry and slightly damp to slightly oily areas
- good tactile feel
- very good fit
- highly flexible

uvex unipur 6634

- moisture-proof NBR safety glove for mechanical applications outdoors
- very good abrasion resistance with the polyamide liner and NBR coating
- good grip in damp areas
- good tactile feel
- good fit
- highly flexible



	uvex unilite 6605
Art. no.	60573
Design	knitted cuff
Standard	EN 388 (4 1 2 2 X)
Material	polyamide
Coating	palm and fingertips coated with nitrile foam coating
Suitable for	dry and slightly damp areas
Colour	black, black
Sizes	6 to 11
Order quantity multiples	10 PR

	uvex unilite 7700
Art. no.	60585
Design	knitted cuff
Standard	EN 388 (4 1 2 1 X)
Material	polyamide, elastane
Coating	palm and fingertips coated with NBR/polyurethane coating
Suitable for	dry and damp, oily working conditions
Colour	grey, black
Sizes	7 to 11
Order quantity multiples	10 PR

	uvex unipur 6634
Art. no.	60321
Design	knitted cuff
Standard	EN 388 (4 1 3 1 X)
Material	polyamide
Coating	palm and fingertips coated with NBR coating
Suitable for	damp, oily or greasy areas of application
Colour	grey, black
Sizes	7 to 10
Order quantity multiples	10 PR



Mechanical Risks

Area of application: precision/all-round



60943



60944



60248



uvex unipur 6630 · uvex unipur 6631

- light and very sensitive PU safety glove for mechanical precision work
- good mechanical abrasion resistance
- good grip in dry and slightly damp areas
- outstanding tactile feel
- very good fit
- highly flexible

	uvex unipur 6630	uvex unipur 6631
Art. no.	60943	60944
Design	knitted cuff	knitted cuff
Standard	EN 388 (4 1 4 1 X)	EN 388 (4 1 4 1 X)
Material	polyamide	polyamide
Coating	palm and fingertips coated with polyurethane coating	palm and fingertips coated with polyurethane coating
Suitable for	dry and slightly damp areas	dry and slightly damp areas
Colour	white, white	grey, grey
Sizes	6 to 11	6 to 11
Order quantity multiples	10 PR	10 PR

uvex unipur 6639

- lightweight, high dexterity and dirt-resistant PU safety glove for mechanical precision work
- good mechanical abrasion resistance
- good grip in dry and slightly damp areas
- outstanding tactile feel
- very good fit
- highly flexible

	uvex unipur 6639
Art. no.	60248
Design	knitted cuff
Standard	EN 388 (4 1 3 1 X)
Material	polyamide
Coating	palm and fingertips coated with polyurethane coating
Suitable for	dry and slightly damp areas
Colour	black, black
Sizes	6 to 11
Order quantity multiples	10 PR



Mechanical Risks

Area of application: precision/all-round



60556
▼
Variant with microdots on palm

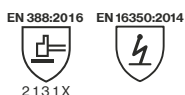

60587
▼
Variant without microdots on palm

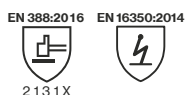

60238



60135



MADE IN GERMANY

uvex unipur carbon

- sensitive and anti-static safety glove for precision work with electronic parts
- very good grip
- fulfils requirement of DIN EN 16350:2014
- very high level of breathability
- outstanding tactile feel
- Art.No. 60556: Made in Germany

	uvex unipur carbon	uvex unipur carbon FT
Art. no.	60556	60587
Design	knitted cuff	knitted cuff
Standard	EN 388 (2 1 3 1 X) EN 16350	EN 388 (2 1 3 1 X) EN 16350
Material	polyamide, carbon	polyamide, carbon
Coating	palm with carbon microdots, fingertips with thin elastomer coating	fingertips with thin elastomer coating
Suitable for	dry areas of application	dry areas of application
Colour	grey, black, white	grey, white
Sizes	6 to 10	6 to 10
Order quantity multiples	10 PR	10 PR

uvex unigrip

- knitted safety gloves with 13-gauge (uvex unigrip PA and uvex unigrip 6620) for precise mechanical work and 10 gauge (uvex unigrip 6624) for rougher mechanical activities
- good grip with the thin PVC dots in dry areas

	uvex unigrip 6624	uvex unigrip 6620
Art. no.	60238	60135
Design	knitted cuff, 10-gauge	knitted cuff, 13-gauge
Standard	EN 388 (2 2 4 2 B)	EN 388 (2 2 4 1 B)
Material	polyamide, cotton	polyamide, cotton
Coating	palm and fingers coated with PVC dots	palm and fingers coated with PVC dots
Suitable for	dry areas of application	dry areas of application
Colour	grey, red	white, blue
Sizes	7 to 10	7 to 10
Order quantity multiples	10 PR	10 PR



Mechanical Risks

Area of application: all-round/heavy duty



Excellent grip in wet conditions



60023

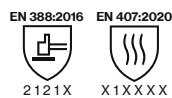

HYG Hydro Grip

MADE IN GERMANY

uvex profi pure HG

- safety glove with uvex Hydro-Grip technology
- outstanding grip in wet working conditions
- heat protection up to 100°C
- excellent wearer comfort thanks to the high moisture absorption of the cotton lining
- dermatologically tested, free from allergenic accelerators
- certified according to OEKO-TEX® Standard 100 (S02-0648 HOHENSTEIN HTTI)
- ergonomic fit
- highly flexible
- good tactile feel

	uvex profi pure HG
Art. no.	60023
Design	knitted cuff
Standard	EN 388 (2 1 2 1 X), EN 407 (X 1 X X X X)
Material	cotton interlock
Coating	palm and whole back of hand with hydro-grip special polymer coating
Suitable for	for damp and wet applications
Colour	white, blue
Sizes	6 to 11
Order quantity multiples	10 PR



Mechanical Risks

Area of application: all-round/heavy duty



Excellent grip in oily conditions

Excellent grip in oily conditions



60558



60208

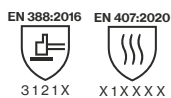
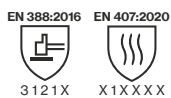

MADE IN GERMANY



uvex profi ergo XG

- safety glove with uvex Xtra-Grip Technology
- outstanding grip in oily working conditions
- heat protection up to 100°C
- very good mechanical abrasion resistance thanks to the multi-layer design for increased service life
- outstanding grip in damp and oily areas
- good tactile feel
- ergonomic fit
- highly flexible
- excellent wearer comfort thanks to the high moisture absorption of the cotton lining
- certified according to OEKO-TEX® Standard 100 (S02-0648 HOHENSTEIN HTTI)

	uvex profi ergo XG20A	uvex profi ergo XG20
Art. no.	60558	60208
Design	knitted cuff	knitted cuff
Standard	EN 388 (3 1 2 1 X), EN 407 (X 1 X X X X)	EN 388 (3 1 2 1 X), EN 407 (X 1 X X X X)
Material	cotton interlock	cotton interlock
Coating	palm and 3/4 of the back of the hand with special NBR coating and Xtra Grip coating (nitrile rubber)	palm and whole back of the hand with special NBR and Xtra Grip coating (nitrile rubber)
Suitable for	oily or greasy areas of application	oily or greasy areas of application
Colour	white, orange, black	white, orange, black
Sizes	6 to 11	6 to 11
Order quantity multiples	10 PR	10 PR



Mechanical Risks

Area of application: all-round/heavy duty



60150



60147



60148

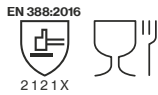

MADE IN GERMANY

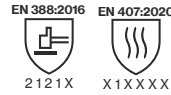

MADE IN GERMANY

uvex contact ergo

- thick, hard-wearing cotton interlock safety glove with NBR coating
- very good grip in damp, wet and oily areas
- good tactile feel
- ergonomic fit
- highly flexible
- excellent wearer comfort thanks to the high moisture absorption of the cotton lining
- certified according to OEKO-TEX® Standard 100 (S02-0648 HOHENSTEIN HTTI)

uvex profi ergo

- cotton interlock safety glove with NBR coating for universal use
- very good grip in damp, wet and oily areas
- good tactile feel
- ergonomic fit
- high flexibility
- very good wearer comfort due to the high water vapour absorption of the cotton lining
- certified according to OEKO-TEX® Standard 100 (S02-0648 HOHENSTEIN HTTI)

	uvex contact ergo ENB20C
Art. no.	60150
Design	knitted cuff
Standard	EN 388 (2 1 2 1 X)
Material	cotton interlock
Coating	palm and fingers with special NBR coating (nitrile rubber)
Suitable for	oily and greasy areas of application
Colour	white, orange
Sizes	6 to 10
Order quantity multiples	10 PR

	uvex profi ergo ENB20A	uvex profi ergo ENB20
Art. no.	60147	60148
Design	knitted cuff	knitted cuff
Standard	EN 388 (2 1 2 1 X), EN 407 (X 1 X X X X)	EN 388 (2 1 2 1 X), EN 407 (X 1 X X X X)
Material	cotton interlock	cotton interlock
Coating	palm and 3/4 of the back of the hand with special NBR coating (nitrile rubber)	palm and whole back of the hand with special NBR coating (nitrile rubber)
Suitable for	damp, oily or greasy areas of application	damp, oily or greasy areas of application
Colour	white, orange	white, orange
Sizes	6 to 11	6 to 10
Order quantity multiples	10 PR	10 PR



Mechanical Risks

Area of application: Heavy duty



89636



60278



60946

60945

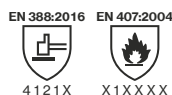

uvex rubiflex

- fully coated cotton interlock safety glove for mechanical activities
- very good mechanical abrasion resistance with NBR coating
- good tactile feel
- ergonomic fit
- certified according to OEKO-TEX® Standard 100 (S02-0648 HOHENSTEIN HTTI)

	uvex rubiflex NB27
Art. no.	89636
Design	gauntlet, approx. 27 cm
Standard	EN 388 (3 1 1 1 X)
Material	cotton interlock
Coating	fully coated with special NBR coating (nitrile rubber)
Suitable for	damp, oily or greasy areas of application
Colour	orange
Sizes	7 to 11
Order quantity multiples	10 PR

uvex unilite 7710 F

- waterproof assembly glove with grip
- excellent grip in wet and oily areas
- extremely abrasion-resistant for heavy-duty activities
- protection against contact heat to 100°C (level 1)
- highly flexible, seamless polyester-knit liner

	uvex unilite 7710F
Art. no.	60278
Design	knitted cuff
Standard	EN 388 (4 1 2 1 X), EN 407 (X 1 X X X X X)
Material	polyester (seamless)
Coating	palm and whole back of the hand with NBR (nitrile rubber) with grip finish
Suitable for	excellent grip in wet and oily areas
Colour	blue, black
Sizes	7 to 11
Order quantity multiples	10 PR

uvex compact

- very durable NBR safety glove for rough work and manual tasks involving raw materials
- very good mechanical abrasion resistance with NBR coating

	uvex compact NB27E	uvex compact NB27H
Art. no.	60946	60945
Design	canvas gauntlet	canvas gauntlet
Standard	EN 388 (4 1 2 1 B)	EN 388 (4 1 2 1 B)
Material	jersey cotton	jersey cotton
Coating	palm and 3/4 of the back of the hand with NBR coating (nitrile rubber)	palm and whole back of the hand with NBR coating (nitrile rubber)
Suitable for	damp, oily or greasy areas of application	damp, oily or greasy areas of application
Colour	white, blue	white, blue
Sizes	9 to 10	10
Order quantity multiples	10 PR	10 PR



Mechanical Risks

Area of application: Heat risks



60213



60179



60595

Sandwich lining

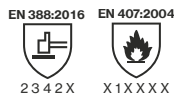

2 3 4 2 X X 1 X X X X

MADE IN GERMANY

Cotton cladding

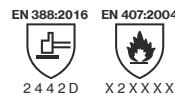

2 4 4 2 D X 2 X X X X

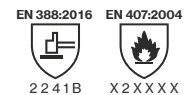

2 2 4 1 B X 2 X X X X

uvex nk

- safety glove for thermal applications
- good mechanical abrasion resistance
- very good grip in dry, damp and oily areas through the rough surface
- very good thermal insulation in direct contact with warm to hot objects
- suitable for contact heat up to +100 °C (as per EN 407)
- certified according to OEKO-TEX® Standard 100 (S02-0648 HOHENSTEIN HTTI)

	uvex NK2722	uvex NK4022
Art. no.	60213	60202
Design	gauntlet,	gauntlet,
	approx. 27 cm	approx. 40 cm
Standard	EN 388 (2 3 4 2 X),	EN 388 (2 3 4 2 X),
	EN 407 (X 1 X X X X)	EN 407 (X 1 X X X X)
Material	cotton interlock, aramid knit	
Coating	fully coated with special NBR coating (nitrile rubber)	
Suitable for	damp, oily or greasy areas of application	
Colour	orange	
Sizes	9 to 10	9 to 10
Order quantity multiples	10 PR	10 PR

uvex k-basic extra

- Kevlar® coarse-knitted glove for mechanical and thermal activities
- very good thermal insulation in direct contact with warm to hot objects
- suitable for contact heat up to +250 °C
- good cut protection
- good wearer comfort with cotton lining on the inside
- breathable

	uvex k-basic extra 6658
Art. no.	60179
Design	knitted cuff, 7-gauge
Standard	EN 388 (2 4 4 2 D),
	EN 407 (X 2 X X X X)
Material	100 % Kevlar®, cotton lining (inside)
Coating	none
Suitable for	cut and heat-resistant
Colour	yellow
Sizes	8, 10, 12
Order quantity multiples	5 PR

uvex profatherm

- cotton terry safety glove for thermal applications
- very good thermal insulation in direct contact with warm to hot objects
- suitable for contact heat up to +250 °C
- good wearer comfort with the cotton terry material on the inside

	uvex profatherm XB40
Art. no.	60595
Design	gauntlet, approx. 40 cm
Standard	EN 388 (2 2 4 1 B),
	EN 407 (X 2 X X X X)
Material	cotton terry
Coating	none
Suitable for	insulation against heat and cold
Colour	white
Sizes	11
Order quantity multiples	6 PR



Mechanical Risks

Area of application: Cold protection



60593

60592



60842



60591

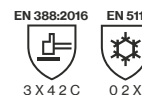
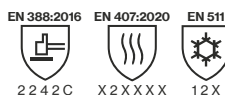
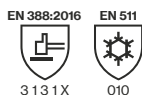
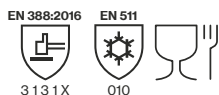

uvex unilite thermo

- winter glove with dual-layer design
- good mechanical abrasion resistance with a polymer coating that is flexible at low temperatures
- very good thermal insulation in direct contact with cold objects
- good fit

uvex unilite thermo plus cut c

- outstanding tactile feel
- high abrasion resistance
- flexible at cold temperatures
- mechanical resistance
- very high cut protection (Level C)



	uvex unilite thermo	uvex unilite thermo plus	uvex unilite thermo FC
Art. no.	60593	60592	60842
Design	knitted cuff	knitted cuff	knitted cuff
Standard	EN 388 (3131X), EN 511 (010)	EN 388 (3131X), EN 511 (010)	EN 388 (2242C), EN 511 (12X), EN 407 (X2XXXX)
Material	acrylic and new wool mix (lining), polyamide and elastane (outer)	acrylic and new wool mix (lining), polyamide and elastane (outer)	acrylic (inner), nylon (outer)
Coating	palm and fingertips with cold-flexible polymer coating	palm and 3/4 of the back of the hand with cold-flexible polymer coating	palm and whole back of hand with natural latex coating, 3/4 grip coating
Suitable for	dry and slightly damp working conditions	dry and slightly damp working conditions	for wet, oily working conditions
Colour	black, black	black, black	red, black
Sizes	7 to 11	7 to 11	7 to 11
Order quantity multiples	10 PR	10 PR	10 PR

	uvex unilite thermo plus cut c
Art. no.	60591
Design	back of the hand partially coated, knitted cuff
Standard	EN 388 (3X42C), EN 511 (02 X)
Material	two-layer design: acrylic (inside), glass/polyamide (outside)
Coating	palm and fingertips with polymer coating that is flexible in the cold
Suitable for	dry and slightly damp working conditions
Colour	lime, black
Sizes	7 to 11
Order quantity multiples	10 PR



Mechanical Risks

Area of application: Working on live parts



60840



60838

EN 60903:2003



Class 0/RC

EN 61482-1-2



Class 1

EN 388:2016



1 X 2 1 X

EN 407:2004



4 1 1 1 X X

EN 61482-1-2



Class 1

MADE IN GERMANY

uvex power protect V1000

- protection against electrical voltages up to 1000V
- due to the anatomical shape the glove offers high dexterity
- high flexibility of the material offers high wearer comfort, even at low temperatures
- arc flash protection class 1 EN 61482-1-2 (box test)

uvex arc protect g1

- ergonomic fit
- good wearer comfort
- exceptional dexterity right to the fingertips
- very good protection against thermal discharge
- arc flash protection class 1 EN 61482-1-2 (box test)
- thermal protection
- certified according to OEKO-TEX® Standard 100 (S02-0648 HOHENSTEIN HTTI)













































	uvex power protect V1000
Art. no.	60840
Design	41 cm straight cuff
Standard	EN 60903 (Class 0/RC), EN 61482-1-2 (Class 1)
Material	no lining
Coating	natural latex, 1,6 mm
Suitable for	good resistance to oils, acids and ozone
Colour	red
Sizes	7 to 11
Order unit	PR

	uvex arc protect g1
Art. no.	60838
Design	27 cm cuff
Standard	388:2016 (1 X 2 1 X), 407 (4 1 1 1 X X), 61482-1-2 (Class 1)
Material	modacryl, cotton, antistatic
Coating	none
Suitable for	for dry areas of application
Colour	anthracite
Sizes	7 to 11
Order quantity multiples	10 PR



Mechanical Risks

Cut protection at a glance

ISO Level 13997	Präzision 	Allround 	Heavy Duty				
F							
							
	uvex phynomic F XG						
D							
	uvex Bamboo TwinFlex D xg	uvex athletic D5 XP	uvex D500 foam				
							
C							
	uvex C500	uvex C500 dry	uvex C300 dry				
							
							
							
							
							
B							
	uvex phynomic B foam	uvex phynomic B XG	uvex athletic B XP	uvex unidur 6641	uvex unidur 6648	uvex unidur 6649	
							
				uvex unidur 6643			

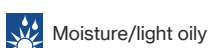

For safety gloves with cut protection level E and above, uvex recommends products from HexArmor®.



Bamboo TwinFlex® technology

High-tech for greater comfort when wearing the cut protection glove



Silky-soft feel and high moisture absorption thanks to bamboo fibre

The only cut protection gloves with natural bamboo fibre: uvex cut protection gloves based on the latest generation of patented uvex Bamboo TwinFlex® technology set new standards in protection, comfort, flexibility, dexterity and economy. The tailor-made cut-protection comfort class helps increase wearer acceptance – particularly when

carrying out demanding activities – as the unique combination of silky-soft bamboo fibre and high-tech protective fibres ensures a high level of wearer comfort and good climate characteristics while also providing effective protection. After all, a safety glove can only help to prevent accidents if the user actually wears it.

Technology

Patented Bamboo TwinFlex® comfort

Silky-soft, comfortable material on the inside of the bamboo-viscose glove ensures very high wearer comfort against the skin. The bamboo fibre not only feels incredibly good on the skin, it also has a very high and quick moisture absorption to keep your skin comfortable and dry while working.

Patented Bamboo TwinFlex® protection

Cut-resistant glass fibres and abrasion-resistant polyamide guarantee optimum mechanical protection. The use of steel fibres in combination with HPPE and polyamide increases the cut protection even to level D.

Bamboo TwinFlex® Technology¹

Cut protection level C		Cut protection level D	
Double Face Principle			
Polyamide (abrasion resistance)	Bamboo (wearer comfort)	Polyamide (abrasion resistance)	Bamboo (wearer comfort)
Glass fibres (cut protection)	High-grade HPPE fibres (tear resistance)	Steel fibres (cut protection)	High-grade HPPE fibres (tear resistance)
e.g. uvex C500 M, uvex C500 und uvex C300		e.g. uvex Bamboo Twinflex D xg, uvex D500 foam	



Bamboo TwinFlex® technology

High-tech for greater comfort when wearing the cut protection glove

First-class climate control

uvex climazone – measurably enhanced comfort

- reduced sweating
- high breathability
- significantly greater moisture absorption compared to other types of fibres

Wearer comfort and an improved microclimate are the ultimate benchmarks in safety gloves. This is why the uvex climazone climate-management system in hand protection is being continuously developed together with market-leading partners and renowned testing and research institutes.



clima zone

NEW
uvex
protexxion zone



Noticeably superior in

- 1 Comfort
- 2 Health
- 3 Cost-effectiveness (long-lasting)
- 4 Protection, touchscreen
- 5 Quality, sustainability

45%

sustainable materials:

- bamboo comfort fibre
- Polyamide-Recyclate



Bamboo TwinFlex® D xg

The latest generation of cut protection gloves – Cut Level D



Comfortable: Silky-soft bamboo fibre



Healthy: tested for skin compatibility



Long-lasting: uvex protexxion zone



Additional feature: Can be used with touchscreens



Local: Made in Germany

XG Xtra Grip
clima zone

60090

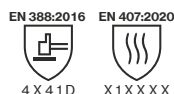

MADE IN GERMANY

uvex Bamboo TwinFlex® D xg

- the patented Bamboo TwinFlex yarn technology ensures fast absorption and high retention of moisture as well as a silky-soft feel against the skin
- uses sustainable raw materials: Bamboo fibre, recycled polyamide
- high level of sensitivity
- adaptive fit: adapts precisely to fit the shape of the hand within a few minutes of wearing
- particularly light, thin and flexible with high cut protection due to the use of the finest steel (Cut Level D)
- touchscreen capability means there is no need to remove the glove
- heat protection: Protection against contact heat up to 100°C
- long service life thanks to uvex protexxion zone and premium Xtra-Grip coating
- uvex protexxion zone with smooth material surface ensures that work processes run smoothly
- dermatologically tested, free from allergenic accelerators
- certified according to OEKO-TEX® Standard 100 (S02-0648 HOHENSTEIN HTTI)



Art. no.	uvex Bamboo TwinFlex® D xg 60090
Design	knitted cuff
Standard	EN 388 (4X41D), EN 407 (X1XXXX)
Material	bamboo viscose, HPPE, steel, polyamide, elastane
Coating	aqua-polymer xtra grip foam coating
Suitable for	dry and damp, oily areas
Colour	green, black
Sizes	6 to 12
Order quantity multiples	10 PR



Mechanical Risks

Area of application: cut protection



60604



MADE IN GERMANY



Crouch zone reinforcement



60498

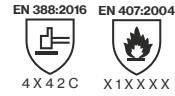

MADE IN GERMANY

uvex D500 foam

- cut protection gloves with excellent wearer comfort, well suited for all-round activities
- high abrasion resistance thanks to the innovative Soft-Grip-Coating
- very good grip in slightly damp environments
- very high uvex cut protection with Bamboo Twin Flex® technology
- high flexibility
- very good tactile feel
- perfect fit with 3D Ergo man mold technology
- certified according to OEKO-TEX® Standard 100 (S02-0648 HOHENSTEIN HTTI)

	uvex D500 foam
Art. no.	60604
Design	knitted cuff
Standard	EN 388 (4 X 4 2 D)
Material	bamboo-rayon, Dyneema® Diamond, steel, polyamide
Coating	palm and fingertips with high-performance elastomer (HPE) and SoftGrip foam coating
Suitable for	dry areas and slightly damp areas
Colour	lime, anthracite
Sizes	7 to 11
Order quantity multiples	10 PR

uvex C500 M foam

- cut protection gloves with excellent wearer comfort, well suited for all-round activities
- outstanding mechanical abrasion resistance thanks to the innovative SoftGrip coating
- very good grip in dry and slightly damp environments
- very high level of cut protection with patented Bamboo TwinFlex® technology
- suitable for contact heat up to +100 °C, in line with EN 407
- partially reinforced thumb joints
- very good tactile feel, high level of flexibility
- perfect fit with 3D Ergo man mould technology
- silicone-free according to imprint test
- certified according to OEKO-TEX® Standard 100 (S02-0648 HOHENSTEIN HTTI)

	uvex C500 M foam
Art. no.	60498
Design	crouch zone reinforcement, knitted cuff
Standard	EN 388 (4 X 4 2 C), EN 407 (X 1 X X X X)
Material	bamboo-rayon, HPPE, glass, polyamide
Coating	High Performance Elastomer (HPE), SoftGrip foam
Suitable for	for dry and slightly oily/damp areas
Colour	lime, black, anthracite
Sizes	7 to 11
Order quantity multiples	10 PR



Mechanical Risks

Area of application: cut protection



60491

60497

60496

60600

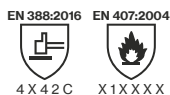

MADE IN GERMANY

uvex C500

- cut protection glove or forearm protection (uvex C500 sleeve) with excellent wearer comfort, well suited for all-round activities
- outstanding mechanical abrasion resistance thanks to the innovative Soft Grip coating (uvex C500 wet plus and uvex C500 XG)
- very good grip in dry (all models), slightly damp/wet (uvex C500 wet plus) and oily (uvex C500 XG) environments
- very high level of cut protection with patented uvex Bamboo TwinFlex® technology

- highly flexible
- very good tactile feel
- perfect fit with 3D Ergo technology
- silicone-free according to imprint test
- certified according to OEKO-TEX® Standard 100 (S02-0648 HOHENSTEIN HTTI)



	uvex C500 sleeve	uvex C500	uvex C500 wet plus	uvex C500 XG
Art. no.	60491-07 60491-10	60497	60496	60600
Design	underarm protection with velcro fastening, 34 cm (M), 40 cm (L)	knitted cuff	knitted cuff	knitted cuff
Standard	EN 388 (2 X 4 X C)	EN 388 (1 X 4 X C)	EN 388 (4 X 4 2 C), EN 407 (X 1 X X X X)	EN 388 (4 X 4 2 C)
Material	bamboo rayon, HPPE, glass, polyamide	bamboo rayon, HPPE, glass, polyamide	bamboo rayon, HPPE, glass, polyamide	bamboo rayon, HPPE, glass, polyamide
Coating	none	none	palm and 3/4 of the back of the hand with high performance elastomer (HPE) coating	palm and whole back of the hand with high performance elastomer (HPE) and Xtra Grip coating
Suitable for	dry areas of application	dry areas of application	damp, oily or greasy areas of application	damp, wet, oily or greasy areas of application
Colour	lime	lime	lime, anthracite	lime, anthracite
Sizes	M L	7 to 11	7 to 11	7 to 11
Order quantity multiples/	PC PC	10 PR	10 PR	10 PR
Order unit				



Mechanical Risks

Area of application: cut protection



60499



60494



60492

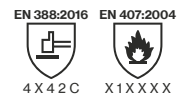
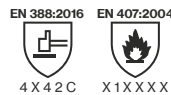

MADE IN GERMANY

uvex C500

- cut protection safety gloves with outstanding wearer comfort
- outstanding mechanical abrasion resistance thanks to the innovative SoftGrip coating (uvex C500 foam and uvex C500 wet)
- very good grip in dry (all models), slightly damp (uvex C500 foam) and wet (uvex C500 wet) environments
- very high level of cut protection with patented uvex Bamboo TwinFlex® technology

- in line with EN 407, the model is suitable for contact heat up to +100°C (uvex C500 foam and C500 sleeve)
- highly flexible
- very good tactile feel
- perfect fit with 3D Ergo technology
- silicone-free according to imprint test
- certified according to OEKO-TEX® Standard 100 (S02-0648 HOHENSTEIN HTTI)

	uvex C500 dry	uvex C500 foam	uvex C500 wet
Art. no.	60499	60494	60492
Design	knitted cuff	knitted cuff	knitted cuff
Standard	EN 388 (X X 4 X C)	EN 388 (4 X 4 2 C), EN 407 (X 1 X X X X)	EN 388 (4 X 4 2 C), EN 407 (X 1 X X X X)
Material	bamboo rayon, HPPE, glass, polyamide	bamboo rayon, HPPE, glass, polyamide	bamboo rayon, HPPE, glass, polyamide
Coating	palm and fingers with high performance vinyl (HPV) grip dots	palm and fingertips with high performance elastomer (HPE) and Soft Grip foam coating	palm and fingertips with high performance elastomer (HPE) coating
Suitable for	dry areas of application	dry areas of application	damp, oily or greasy areas of application
Colour	lime, anthracite	lime, anthracite	lime, anthracite
Sizes	7 to 11	7 to 11	7 to 11
Order quantity multiples	10 PR	10 PR	10 PR



Mechanical Risks

Area of application: cut protection



60549



60544



60542

EN 388:2016



X X 4 X C

EN 388:2016



3 X 4 2 C

EN 388:2016



4 X 4 2 C



MADE IN GERMANY



uvex C300

- cut protection glove with excellent wearer comfort
- outstanding mechanical abrasion resistance thanks to the innovative SoftGrip coating (uvex C300 foam and uvex C300 wet)
- very good grip in dry (all models), slightly damp (uvex C300 foam) and wet (uvex C300 wet) environments
- good cut protection with patented uvex Bamboo TwinFlex® technology

- highly flexible
- very good tactile feel
- perfect fit with 3D Ergo technology
- silicone-free according to imprint test
- certified according to OEKO-TEX® Standard 100 (S02-0648 HOHENSTEIN HTTI)

	uvex C300 dry	uvex C300 foam	uvex C300 wet
Art. no.	60549	60544	60542
Design	knitted cuff	knitted cuff	knitted cuff
Standard	EN 388 (X X 4 X C)	EN 388 (3 X 4 2 C)	EN 388 (4 X 4 2 C)
Material	bamboo rayon, HPPE, glass, polyamide	bamboo rayon, HPPE, glass, polyamide	bamboo rayon, HPPE, glass, polyamide
Coating	palm and fingers with high performance vinyl (HPV) grip dots	palm and fingertips with high performance elastomer (HPE) and Soft Grip foam coating	palm and fingertips with high performance elastomer (HPE) coating
Suitable for	dry areas of application	dry areas of application	damp, oily or greasy areas of application
Colour	anthracite	anthracite	anthracite
Sizes	7 to 11	7 to 11	7 to 11
Order quantity multiples	10 PR	10 PR	10 PR



uvex phynomic

Perfection in 3 dimensions

- 1. Outstanding health protection:**
certified according to proDERM and uvex harmful substances standards
- 2. Sustainability:**
CO₂-neutral production in Lueneburg
- 3. Extreme durability reduces costs and waste**

Choose the ideal phynomic cut protection glove for your application:
Additional functions such as Xtra-Grip for oily areas, touchscreen and ESD compatibility and suitability for the food industry enable these products to be used in a variety of special application areas.
uvex phynomic cut protection gloves are available with cut protection levels B to F. The uvex phynomic C XG and uvex phynomic F XG are available with additional protection in the thumb croch as an option: The uvex protexxion zone further increases the service life.



Unique uvex XG coating with excellent grip in oily conditions ▶

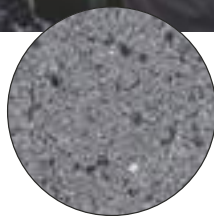

uvex phynomic cut protection products are now also available with our well-known and popular XG coating.

This Xtra-Grip coating is designed for excellent grip in oily conditions and for increased grip during mechanical activities in slightly damp and oily applications.
High cut protection, with high sensitivity – now with cut protection level F.

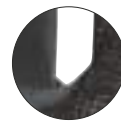

Optional thumb croch reinforcement ▶



60068



MADE IN GERMANY

uvex phynomic F XG

- sensitive glove with very high cut protection level (Cut F) and excellent grip in oily conditions, for mechanical activities
- outstanding mechanical abrasion resistance
- thanks to the Aqua-Polymer-Xtra-Grip coating
- excellent grip in oily, slightly damp, and dry areas
- heat protection up to 100°C
- touchscreen compatibility for use with almost all screens, tablets and mobile phones
- high level of breathability thanks to the porous foam coating
- excellent tactile feel when assembling (oily) parts
- free from accelerators for health protection and skin compatibility dermatologically approved (proDERM®), highly suitable for allergy sufferers
- certified according to OEKO-TEX® Standard 100 (S02-0648 HOHENSTEIN HTTI)

	uvex phynomic F XG
Art. no.	60068
Design	knitted cuff
Standard	EN 388 (4 X 4 4 F)
Material	polyamide, elastane, HPPE, glass, steel
Coating	aqua-polymer foam coating on palm and fingertips Xtra-Grip foam coating
Suitable for	for damp and oily areas
Colour	black, black
Sizes	6 to 12
Order quantity multiples	10 PR



Mechanical Risks

Area of application: cut protection



60080

EN 388:2016



4 X 4 3 B

MADE IN GERMANY



60044

EN 388:2016



4 X 4 2 B

MADE IN GERMANY



uvex phynomic B foam

- sensitive cut protection safety glove for mechanical activities
- suitable for use in the food industry
- very good mechanical abrasion resistance thanks to the damp-resistant aqua-polymer foam coating
- good grip in dry and slightly damp areas
- good cut protection and high tear resistance
- highly breathable coating
- outstanding tactile feel when assembling parts
- certified according to OEKO-TEX® Standard 100 (S02-0648 HOHENSTEIN HTTI)

uvex phynomic B XG

- sensitive cut protection glove, with excellent grip in oily conditions, for mechanical activities
- outstanding mechanical abrasion resistance thanks to the aqua-polymer XtraGrip coating
- excellent grip in oily, slightly damp, and dry areas
- touchscreen compatibility for use with almost all screens, tablets and mobile phones
- high level of breathability thanks to the porous foam coating
- excellent tactile feel when assembling (oily) parts
- free from accelerators for health protection and skin compatibility dermatologically approved (proDERM®), highly suitable for allergy sufferers
- good cut protection and high tear resistance
- certified according to OEKO-TEX® Standard 100 (S02-0648 HOHENSTEIN HTTI)



	uvex phynomic B foam
Art. no.	60080
Design	knitted cuff
Standard	EN 388 (4 X 4 3 B)
Material	polyamide, elastane, HPPE, glass, carbon
Coating	aqua-polymer foam coating on palm and fingertips Xtra-Grip foam coating
Suitable for	for damp and oily areas
Colour	sky blue, grey
Sizes	6 to 12
Order quantity multiples	10 PR

	uvex phynomic B XG
Art. no.	60044
Design	knitted cuff
Standard	EN 388 (4 X 4 2 B)
Material	polyamide, elastane, HPPE, glass, carbon
Coating	aqua-polymer foam coating on palm and fingertips Xtra-Grip foam coating
Suitable for	for damp and oily areas
Colour	sky blue, black
Sizes	6 to 12
Order quantity multiples	10 PR



Mechanical Risks

Area of application: cut protection



60081

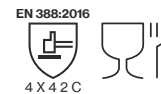

MADE IN GERMANY

protecting planet
by maximum reduction of pollutants // by using biobased material

With the uvex phynomic C5 cut protection glove, we protect not only your hands, but also all of our resources.

The uvex phynomic C5 is manufactured with bio-based HPPE (DSM Dyneema). The high-performance fibres provide cut protection and increase the tear resistance of the glove. Usually, HPPE is based on crude oil, a finite raw material.



BIO-BASED DYNEEMA® FIBER AT HEART

Because it matters

Bio-based HPPE is derived from oils produced during the pulp production process. The underlying raw material for pulp products, such as various papers, is wood. This means that the raw material that is used in your safety glove is renewable and therefore more sustainable.

In the uvex phynomic C5, bio-based HPPE accounts for least 45% of the weight of the glove.

uvex phynomic C5

- all-round cut protection safety glove for mechanical activities
- suitable for use in the food industry
- very good mechanical abrasion resistance thanks to the moisture-resistant aqua-polymer foam coating
- very good grip in dry and slightly damp areas
- very good cut protection (level C) and high tear resistance
- highly breathable coating
- outstanding tactile feel when assembling parts
- sustainable: with 45% bio-based HPPE (DSM Dyneema)
- certified according to OEKO-TEX® Standard 100 (S02-0648 HOHENSTEIN HTTI)

	uvex phynomic C5
Art. no.	60081
Design	knitted cuff
Standard	EN 388 (4 X 4 2 C)
Material	Dyneema® Diamond Technology (bio-based), polyamide, elastane
Coating	palm and fingertips with aqua-polymer foam coating
Suitable for	dry areas and slightly damp areas
Colour	blue, grey
Sizes	6 to 12
Order quantity multiples	10 PR



Mechanical Risks

Area of application: cut protection

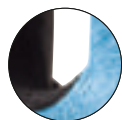

Optional thumb crotch reinforcement ▶



60047

EN 388:2016



4 X 4 2 C



Xtra Grip

MADE IN GERMANY



60048

EN 388:2016 EN 16350:2014



3 X 4 2 C



Xtra Grip

MADE IN GERMANY

uvex phynomic C XG

- sensitive cut protection safety glove for mechanical activities
- suitable for use in the food industry
- very good mechanical abrasion resistance thanks to the damp-resistant aqua-polymer foam coating
- good grip in dry and slightly damp areas
- good cut protection and high tear resistance
- highly breathable coating
- outstanding tactile feel when assembling parts
- certified according to OEKO-TEX® Standard 100 (S02-0648 HOHENSTEIN HTTI)

uvex phynomic C XG ESD

- sensitive cut protection glove, with excellent grip in oily conditions, for mechanical activities
- ESD function (DIN EN 16350:2014)
- outstanding mechanical abrasion resistance thanks to the aqua-polymer XtraGrip coating
- excellent grip in oily, slightly damp, and dry areas
- touchscreen compatibility for use with almost all screens, tablets and mobile phones
- free from accelerators for health protection and skin compatibility dermatologically approved (proDERM®), highly suitable for allergy sufferers
- certified according to OEKO-TEX® Standard 100 (S02-0648 HOHENSTEIN HTTI)



	uvex phynomic C XG
Art. no.	60047
Design	knitted cuff
Standard	EN 388 (4 X 4 2 C)
Material	polyamide, elastane, HPPE, glass, carbon
Coating	aqua-polymer foam coating on palm and fingertips Xtra-Grip foam coating
Suitable for	damp and oily areas
Colour	sky blue, grey
Sizes	6 to 12
Order quantity multiples	10 PR

	uvex phynomic C XG ESD
Art. no.	60048
Design	knitted cuff
Standard	EN 388 (3 X 4 2 C), EN 16350
Material	polyamide, elastane, HPPE, glass, carbon
Coating	aqua-polymer foam coating on palm and fingertips Xtra-Grip foam coating
Suitable for	damp and oily areas
Colour	blue, black
Sizes	6 to 12
Order quantity multiples	10 PR



Mechanical Risks

Area of application: cut protection



Matt, breathable and durable micro-foam coating ▶

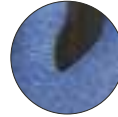

Crotch zone reinforcement ▶



60036



uvex athletic B XP

- very high cut protection (Level B)
- good grip on dry and (slightly) oily/damp workpieces
- very good mechanical abrasion resistance
- reinforced thumb joints
- bio-based HPPE (DSM)
- high flexibility, very good fit
- very good tactile feel
- suitable for industrial washing
- certified according to OEKO-TEX® Standard 100 (S02-0648 HOHENSTEIN HTTI)

The uvex athletic series is known for its excellent wearer comfort.

These gloves effectively combine thin and lightweight materials with a special matt, finely textured and breathable micro-foam coating and a slim fit.

The slim fit make the glove feel like a second skin. Together with the elasticated liner, which contains elastane, the product provides outstanding wearer comfort, enabling fatigue-free work throughout the day.

	uvex athletic B XP
Art. no.	60036
Design	knitted cuff
Standard	EN 388 (4 X 4 4 B)
Material	bio-based HPPE (DSM), glas, polyamide, elastane
Coating	palm and fingertips coated, micro NBR foam coating
Suitable for	dry and slightly damp/oily working conditions
Colour	grey, anthracite
Sizes	6 to 12
Order quantity multiples	10 PR



Mechanical Risks

Area of application: cut protection



60037



60030



uvex athletic C XP

- very high cut protection (Level C)
- good grip on dry and (slightly) oily/damp workpieces
- very good mechanical abrasion resistance
- reinforced thumb joints
- high flexibility, very good fit
- very good tactile feel
- suitable for industrial washing
- certified according to OEKO-TEX® Standard 100 (S02-0648 HOHENSTEIN HTTI)

Art. no.	uvex athletic C XP 60037
Design	knitted cuff
Standard	EN 388 (4 X 4 3 C)
Material	HPPE, glas, polyamide, elastane
Coating	palm and fingertips coated, micro NBR foam coating
Suitable for	dry and slightly damp/oily working conditions
Colour	grey, anthracite
Sizes	6 to 12
Order quantity multiples	10 PR

uvex athletic D5 XP

- very high cut protection (Level D)
- good grip on dry and (slightly) oily/damp workpieces
- very good mechanical abrasion resistance
- reinforced thumb joints
- high flexibility, very good fit
- very good tactile feel
- suitable for industrial washing
- certified according to OEKO-TEX® Standard 100 (S02-0648 HOHENSTEIN HTTI)

Art. no.	uvex athletic D5 XP 60030
Design	knitted cuff
Standard	EN 388 (4 X 4 3 D)
Material	HPPE, steel, polyamide, elastane
Coating	palm and fingertips coated, micro NBR foam coating
Suitable for	dry and slightly damp/oily working conditions
Colour	grey, anthracite
Sizes	6 to 11
Order quantity multiples	10 PR



Mechanical Risks

Area of application: cut protection



60210



60932



60516



uvex unidur 6641

- PU cut protection safety glove with high-quality Special Cut Performance PE fibre
- outstanding mechanical abrasion resistance thanks to a good combination of fibres and coating
- good grip in dry and slightly damp areas
- good cut protection due to high-quality Special Cut Performance PE fibre
- very good tactile feel
- highly flexible
- outstanding comfort

uvex unidur 6648 · uvex unidur 6649

- PU cut protection glove with HPPE fibres
- outstanding mechanical abrasion resistance
- good grip in damp and oily areas
- good cut protection with HPPE fibres
- good tactile feel
- highly flexible
- good wearer comfort

Art. no.	uvex unidur 6641 60210
Design	knitted cuff
Standard	EN 388 (4 3 4 3 B)
Material	HPPE, elastane
Coating	palm and fingertips with polyurethane coating
Suitable for	dry areas and slightly damp areas
Colour	white, grey
Sizes	6 to 11
Order quantity multiples	10 PR

Art. no.	uvex unidur 6648 60932	uvex unidur 6649 60516
Design	knitted cuff	knitted cuff
Standard	EN 388 (4 3 4 2 B)	
Material	HPPE, elastane	HPPE, polyamide, elastane
Coating	palm and fingertips with polyurethane coating	
Suitable for	dry areas and slightly damp areas	
Colour	white, black	mottled blue, grey
Sizes	6 to 11	7 to 11
Order quantity multiples	10 PR	10 PR



Mechanical Risks

Area of application: cut protection



60314



60938



60973

60974



uvex unidur 6643

- NBR cut protection safety glove with high-quality Special Cut Performance PE fibre
- outstanding mechanical abrasion resistance with NBR coating
- good grip in damp and oily areas
- good cut protection due to high-quality Special Cut Performance PE fibre
- good tactile feel
- highly flexible
- good wearer comfort

uvex unidur 6659 foam

- cut protection glove with NBR foam coating and HPPE/glass fibre
- outstanding mechanical abrasion resistance with NBR coating
- good grip in dry and slightly damp areas
- high level of cut protection with HPPE and glass fibre combination
- very good tactile feel
- highly flexible
- outstanding comfort

uvex unidur sleeve C - uvex unidur sleeve C TL

- very high cut protection (Cut Level C)
- very thin and flexible
- high comfort
- velcro fastening for a custom fit
- 60974: thumb loop (TL) for added safety (protection against cuts on the wrist)
- certified according to OEKO-TEX® Standard 100 (S02-0648 HOHENSTEIN HTTI)



Art. no.	uvex unidur 6643 60314
Design	knitted cuff
Standard	EN 388 (4 3 4 4 B)
Material	HPPE, polyamide, elastane
Coating	palm and fingertips with NBR coating
Suitable for	damp, oily or greasy areas of application
Colour	mottled grey, black
Sizes	7 to 10
Order quantity multiples	10 PR

Art. no.	uvex unidur 6659 foam 60938
Design	knitted cuff
Standard	EN 388 (4 X 4 4 C)
Material	HPPE, glass, polyamide
Coating	palm and fingertips with nitrile foam coating
Suitable for	dry areas and slightly damp areas
Colour	mottled grey, black
Sizes	6 to 11
Order quantity multiples	10 PR

Art. no.	uvex unidur sleeve C 60973	uvex unidur sleeve C TL 60974
Design	Lower arm protection with velcro fastening	Lower arm protection with velcro fastening with thumb loop
	46 cm (size M), 50 cm (size L)	
Standard	EN 388 (2 X 4 X C)	
Material	HPPE, glass, polyamide	
Coating	without coating	
Suitable for	for dry areas	
Colour	mottled grey	mottled grey
Sizes	M, L	M, L
Order unit	PC	PC



uvex glove expert

Consultation and product expertise from a single source

The uvex Glove Navigator

The fast route to finding the right gloves for you
 The uvex Glove Navigator guides you through the entire uvex safety glove range



<https://www.uvex-safety.com/en/products/schutzhandschuhberater/>

uvex Chemical Expert System:

Online chemicals database and glove plans
 As a manufacturer, we offer you access to our extensive on-line chemicals database. In just a few steps, you can access information about the resistance of our safety gloves when handling chemicals.

Register for free and get access to the following premium features:

- Full access to the test results of all listed chemicals
- Creation and management of your own permeation lists
- Use of the glove plan designer: Access the glove plans created by our experts.
- Creation and management of your own glove plans



<https://ces.uvex.de>

uvex glove expert (online)

Chemicals database for safety gloves

Sort by Hazardous substance ↔ Safety gloves (permeation lists)



Gloves plan designer

Sort by Activity ↔ Safety gloves (glove plans)

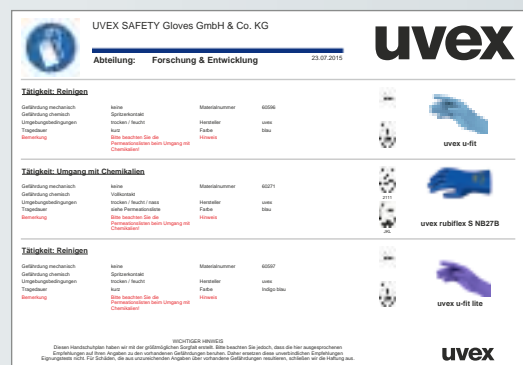



Chemical Risks

Selecting the right hand protection

Chemical protection gloves must be used in a wide variety of areas of application while still enabling wearers to complete tasks effectively.

This is why uvex very pays close attention to the requirements placed on the product in the possible areas of application when developing new chemical protection gloves.

The matrix shown will help you choose the most suitable material for chemical protection gloves:

Handling chemicals	Example industries	Potential contact/splash	Irregular contact	Permanent contact	Explosion-prone area
aliphatic (grease, mineral oil)	Cleaning agents petroleum industry Adhesives Paint production	Nitrile	Nitrile	Nitrile	uvex rubiflex ESD
Polar	Cleaner/universal thinner Loctite/industrial adhesive Coating industry Printing industry Raw materials in the chemical industry Intermediates in the chemical industry	Nitrile Chloroprene	Nitrile Chloroprene	Butyl	uvex profabutyl
polar (alcohols)	Disinfectant, raw materials in the chemical industry	Nitrile Chloroprene	Nitrile Chloroprene	Nitrile Chloroprene Butyl	uvex rubiflex ESD, uvex profabutyl
aromatic, halogenated	Solvents for paints, resins, oils etc. Adhesives Printing and coating industry	Nitrile	Nitrile	Viton	
aqueous solutions, diluted acids/bases	water treatment (sewage plant) commercial cleaning	Nitrile Chloroprene	Nitrile Chloroprene	Nitrile Chloroprene Chloroprene/nitrile	uvex rubiflex ESD
concentrated acids/bases	electroplating surface treatment of aluminium (anodised), steel, raw materials in the chemical industry, fertiliser production, food industry/raw materials in the polymer industry	Nitrile Chloroprene	Nitrile Chloroprene	Nitrile Chloroprene Chloroprene/nitrile Butyl	uvex profabutyl



uvex rubiflex S – Put them on and feel great.

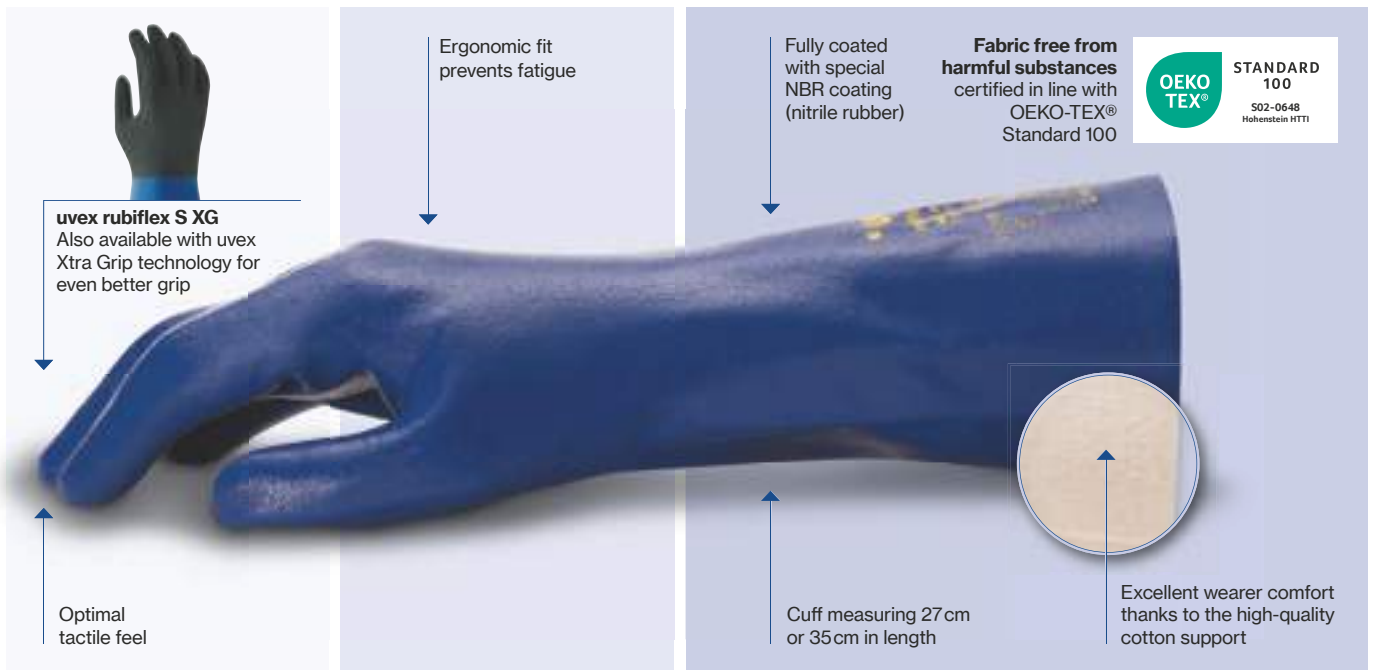

Precise working

The uvex rubiflex S fits perfectly on the hand. Its ergonomic design guarantees an optimal fit.

No fatigue

The ergonomic shape of the uvex rubiflex S saves the wearer effort and increases wearer acceptance.

Active protection for the skin

The cotton lining absorbs four times more moisture than synthetic fibres (polyamide/polyester), ensuring that the wearer's skin stays dry and the gloves feel comfortable and natural to wear.

The uvex rubiflex S series offers a unique combination of:

Comfort

Every single model in the uvex rubiflex range stands for ergonomic fit and excellent wearer comfort thanks to the high level of moisture absorption offered by the cotton lining, which helps to prevent moisture build-up inside the glove.

Safety

The supported safety glove provides effective protection when working with substances such as greases, mineral oils and a wide range of chemicals. The uvex rubiflex S XG with innovative Xtra Grip coating ensures excellent grip. In this way, tools and machines can be operated safely at all times.

Sustainability

The rubiflex safety gloves are manufactured at the uvex site in Lüneburg – producing high-quality occupational health and safety “Made in Germany”.

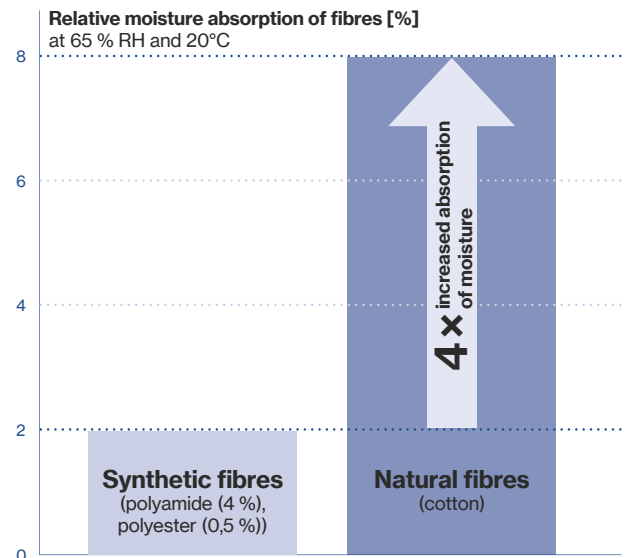

Chemical Risks

Safety gloves with cotton support: NBR coating



60557



60224

LABS-conformity VDMA
24364-A1/A2-L/W

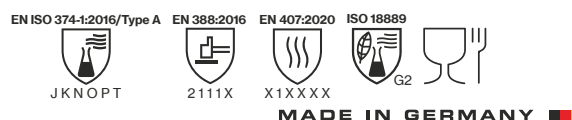
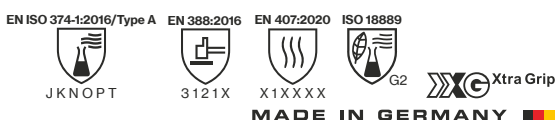

uvex rubiflex S XG

- lightweight, stockinette NBR chemical protection glove with optimal grip properties
- very good mechanical abrasion resistance and good lifecycle thanks to multi-layered structure
- outstanding grip in wet and oily areas thanks to uvex Xtra Grip technology
- good resistance to grease, mineral oils and many chemicals
- very good tactile feel
- ergonomic fit
- outstanding wearer comfort due to the high-quality cotton interlock supporting material
- extremely high flexibility
- certified according to OEKO-TEX® Standard 100 (S02-0648 HOHENSTEIN HTTI)

	uvex rubiflex S XG27B	uvex rubiflex S XG35B
Art. no.	60560	60557
Design	gauntlet, approx. 27 cm	gauntlet, approx. 35 cm
Standard	EN 388 (3 1 2 1 X)	EN 388 (3 1 2 1 X), ISO 18889 (G2)
	EN ISO 374-1:2016/Type A (J K N O P T), EN 407 (X 1 X X X X)	
Material	cotton interlock	cotton interlock
Coating	fully coated with special NBR coating (nitrile rubber) and XG Grip coating, approx. 0.40 mm	fully coated with special NBR coating (nitrile rubber) and XG Grip coating, approx. 0.40 mm
Suitable for	very good resistance to grease, mineral oils and many chemicals	very good resistance to grease, mineral oils and many chemicals
Colour	blue, black	blue, black
Sizes	7 to 11	7 to 11
Order quantity multiples	10 PR	10 PR

uvex rubiflex S

- very lightweight, stockinette NBR chemical protection glove suited to handling a variety of chemicals
- good mechanical abrasion resistance thanks to the NBR coating
- good grip in damp and wet areas
- good resistance to grease, mineral oils and many chemicals
- outstanding tactile feel
- ergonomic fit
- outstanding wearer comfort due to the high-quality cotton interlock supporting material
- extremely high flexibility
- certified according to OEKO-TEX® Standard 100 (S02-0648 HOHENSTEIN HTTI)

	uvex rubiflex S NB27B	uvex rubiflex S NB35B
Art. no.	60271	60224
Design	gauntlet, approx. 27 cm	gauntlet, approx. 35 cm
Standard	EN 388 (2 1 1 1 X)	EN 388 (2 1 1 1 X), ISO 18889 (G2)
	EN ISO 374-1:2016/Type A (J K N O P T), EN 407 (X 1 X X X X)	
Material	cotton interlock	cotton interlock
Coating	fully coated with special NBR coating (nitrile rubber), approx. 0.40 mm	fully coated with special NBR coating (nitrile rubber), approx. 0.40 mm
Suitable for	good resistance to grease, mineral oils and many chemicals	good resistance to grease, mineral oils and many chemicals
Colour	blue	blue
Sizes	7 to 11	6 to 11
Order quantity multiples	10 PR	10 PR



Chemical Risks

Safety gloves with cotton support: NBR coating



EN ISO 374-1:2016/Type A EN 388:2016 EN 407:2020

J K N O P T 2121X X1XXXX

MADE IN GERMANY

EN ISO 374-1:2016/Type B EN 388:2016 EN 407:2020

J K O P T 2121X X1XXXX

MADE IN GERMANY

uvex rubiflex S

- NBR chemical protection glove with reinforced cotton interlock supporting material
- good mechanical abrasion resistance thanks to the NBR coating
- good resistance to many chemicals, acids, alkalis, mineral oils and solvents
- good heat insulation with reinforced supporting material
- good tactile feel
- ergonomic fit
- outstanding wearer comfort due to the high-quality cotton interlock supporting material
- highly flexible
- certified according to OEKO-TEX® Standard 100 (S02-0648 HOHENSTEIN HTTI)

uvex rubiflex S	NB27S	NB35S	NB40S
Art. no.	89646	98891	98902
Design	gauntlet, approx. 27 cm	gauntlet, approx. 35 cm	gauntlet, approx. 40 cm
Standard	EN 388 (2 1 2 1 X), EN ISO 374-1:2016 / Type A (J K N O P T), EN 407 (X 1 X X X X)		
Material	cotton interlock, reinforced	cotton interlock, reinforced	cotton interlock, reinforced
Coating	fully coated with NBR special coating (nitrile rubber), approx. 0.50 mm	fully coated with NBR special coating (nitrile rubber), approx. 0.50 mm	fully coated with NBR special coating (nitrile rubber), approx. 0.50 mm
Suitable for	very good resistance to grease, mineral oils and many chemicals		
Colour	green	green	green
Sizes	8 to 11	8 to 11	8 to 11
Order quantity multiples	10 PR	10 PR	10 PR

uvex rubiflex S (long version)

- long NBR chemical protection glove with reinforced cotton interlock supporting material
- additional elastic collar at gauntlet end (NB60SZ/NB80SZ)
- good mechanical abrasion resistance thanks to the NBR coating
- good resistance to many chemicals, acids, alkalis, mineral oils and solvents
- good tactile feel
- ergonomic fit
- outstanding wearer comfort due to the high-quality cotton interlock supporting material
- highly flexible
- certified according to OEKO-TEX® Standard 100 (S02-0648 HOHENSTEIN HTTI)

uvex rubiflex S	NB60S	NB80S	NB60SZ	NB80SZ
Art. no.	89647	60190	89651	60191
Design	gauntlet, approx. 60 cm	gauntlet, approx. 80 cm	elastic collar at gauntlet end, approx. 60 cm	elastic collar at gauntlet end, approx. 80 cm
Standard	EN 388 (2 1 2 1 X), EN ISO 374-1:2016/Type B (J K O P T), EN 407 (X 1 X X X X)			
Material	cotton interlock, reinforced	cotton interlock, reinforced	cotton interlock, reinforced	cotton interlock, reinforced
Coating	fully coated with special NBR coating (nitrile rubber), approx. 0.50 mm			
Suitable for	very good resistance to grease, mineral oils and many chemicals			
Colour	green	green	green	green
Sizes	9 to 11	9 to 11	9 to 11	9 to 11
Order quantity multiples	10 PR	10 PR	10 PR	10 PR

Chemical Risks

Area of application: cut protection



MADE IN GERMANY

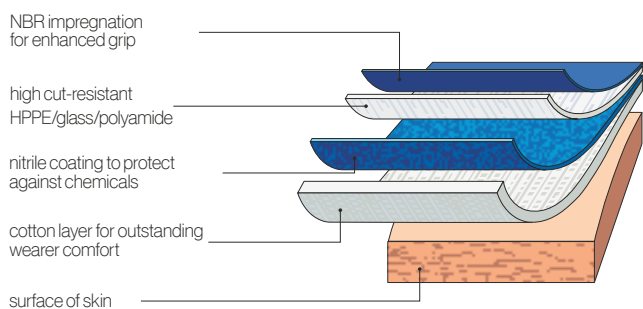

uvex protector chemical

- very robust safety glove with multi-layer technology combining impermeability and optimal cut protection
- very high level of cut protection with the multi-layer design of the supporting material made from cotton, HPPE and glass
- good grip in damp, wet and oily areas
- uvex protector chemical also offers protection against chemicals
- good wearer comfort
- certified according to OEKO-TEX® Standard 100 (S02-0648 HOHENSTEIN HTTI)



	uvex protector chemical NK2725B	uvex protector chemical NK4025B
Art. no.	60535	60536
Design	gauntlet, approx. 27 cm	gauntlet, approx. 40 cm
Standard	EN 388 (4 X 4 4 C), EN ISO 374-1:2016/ Type A (J K N O P T)	EN 388 (4 X 4 4 C), EN ISO 374-1:2016/ Type A (J K N O P T)
Material	sandwich liner: cotton interlock, HPPE, glass, PA	
Coating	fully coated with special NBR coating (nitrile rubber)	
Suitable for	good resistance to oil, grease and many chemicals	
Colour	blue	blue
Sizes	9 to 10	9 to 10
Order quantity multiples	10 PR	10 PR

Chemical Risks

Safety gloves with cotton support: conductive NBR coating

The ideal solution for areas with explosive atmospheres

The introduction of the new standard EN 16350:2014 (Protective gloves – electrostatic properties) is the first standard to prescribe the electrostatic properties and testing procedure of safety gloves for work environments with risk of explosive atmospheres and fire.

- The testing conditions and minimum requirements in accordance with EN 16350:2014 are as follows:
- The contact resistance must be less than $1.0 \times 10^8 \Omega$ ($R_V < 1.0 \times 10^8 \Omega$).
- Contact resistance R_V was tested in accordance with EN 1149-2:1997.
- Test atmosphere: ambient temperature $23^\circ\text{C} \pm 1^\circ\text{C}$, relative air humidity $25\% \pm 5\%$.

uvex rubiflex ESD fulfils the requirements of the new norm EN 16350:2014.



Functional combination of liner and coating

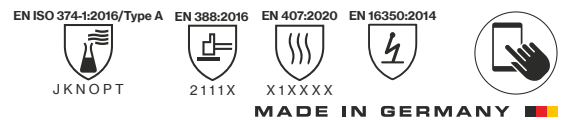
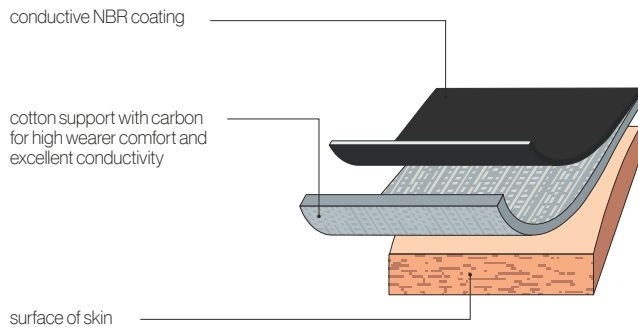

uvex rubiflex ESD

- lightweight, stockinette and anti-static NBR chemical protection glove for applications in areas with explosion risks
- good mechanical abrasion resistance thanks to the NBR coating
- good grip in damp and wet areas
- good resistance to grease, mineral oils and many chemicals
- outstanding tactile feel
- ergonomic fit
- outstanding wearer comfort due to the high-quality cotton interlock/carbon supporting material
- extremely high flexibility
- certified according to OEKO-TEX® Standard 100 (S02-0648 HOHENSTEIN HTTI)

uvex rubiflex ESD	NB27A	NB35A
Art. no.	60880	60954
Design	gauntlet, approx. 27 cm	gauntlet, approx. 35 cm
Standard	EN 388 (2 111 X), EN ISO 374-1:2016 / Type A (J K N O P T), EN 16350, EN 407 (X 1 X X X X)	
Material	cotton interlock/carbon	cotton interlock/carbon
Coating	fully coated with special conductive NBR coating (nitrile rubber), approx. 0.40 mm	
Suitable for	good resistance to grease, mineral oils and many chemicals	
Colour	black	black
Sizes	6 to 11	6 to 11
Order quantity multiples	10 PR	10 PR

Chemical Risks

Unsupported safety gloves



60949



60957

EN ISO 374-1:2016/Type A EN 388:2016 EN 16350:2014



ABIKLNOT



2010X



MADE IN GERMANY

EN ISO 374-1:2016/Type A EN 388:2016



AFKLMN



2120A

MADE IN GERMANY



uvex profabutyl

- chemical protection glove without stockinette made from butyl rubber
- good grip in damp and wet areas
- good resistance to polar bonds such as esters, ketones, aldehydes, amines and saturated saline solutions, plus acids and alkalis
- good fit
- highly flexible
- satisfies the requirements of DIN EN 16350:2014

Art. no.	uvex profabutyl B-05R 60949
Design	gauntlet, rolled edge, approx. 35 cm
Standard	EN 388 (2 0 1 0 X), EN 374 (A B I K L N O T), EN 16350
Material	without stockinette
Coating	seamlessly coated with bromobutyl (approx. 0.50 mm)
Suitable for	good resistance to polar bonds acids and alkalis
Colour	black
Sizes	7 to 11
Order unit	PR

uvex profaviton

- chemical protection gloves made from butyl rubber with Viton® outer layer
- good grip in damp and wet areas
- good resistance to aliphatic and aromatic hydrocarbons (e.g. hexane, benzene, toluene, xylene and others), halogenated hydrocarbons (e.g. trichloroethylene, perchloroethylene, dichloromethane and others) organic and inorganic acids (diluted to concentrated), as well as saturated saline solutions
- good fit
- highly flexible

Art. no.	uvex profaviton BV-06 60957
Design	gauntlet, rolled edge, approx. 35 cm
Standard	EN 388 (2 1 2 0 A), EN ISO 374-1:2016/Type A (A F K L M N)
Material	without stockinette
Coating	seamlessly coated with bromobutyl (approx. 0.40 mm) and Viton® outer layer (approx. 0.20 mm)
Suitable for	good resistance to aliphatic and aromatic hydrocarbons, halogenated hydrocarbons
Colour	black
Sizes	8 to 11
Order unit	PR

Chemical Risks

Safety gloves with bamboo-fiber/nylon support: NBR coating



60971



60968



LABS-conformity VDMA
24364-A1/A2-L/W

60188



JKLOPT

2121X

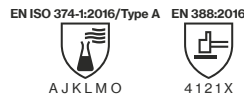

AJKLMO

4121X



ACJKL MNOPST

VIRUS

3121X

X1XXXX

uvex u-chem 3300

- outstanding wearer comfort
- comfortable bamboo-fiber inside
- absorption function of the natural fiber
- extremely high dexterity
- outstanding tactile feel good resistance to many chemicals

	uvex u-chem 3300
Art. no.	60971
Design	cuff, fully coated, approx. 32 cm
Standard	EN 388 (2 12 1 X), EN ISO 374-1:2016 / Type A (J K L O P T)
Material	Bamboo-rayon/Nylon (seamless)
Coating	NBR (nitrile butadiene rubber), approx. 0.21 mm
Suitable for	good resistance to grease, mineral oils and many chemicals
Colour	blue
Sizes	7 to 11
Order quantity multiples	10 PR

uvex u-chem 3100

- the perfect combination of chemical protection and grip
- very good mechanical protection
- comfortable fit due to seamless cotton liner
- good resistance to many chemicals
- very good grip in wet and oily conditions
- highly flexible

	uvex u-chem 3100
Art. no.	60968
Design	cuff, fully coated, approx. 30 cm
Standard	EN 388 (4 1 2 1 X), EN ISO 374-1:2016 / Type A (A J K L M O)
Material	cotton (seamless)
Coating	NBR (nitrile butadiene rubber), approx. 0.50 mm
Suitable for	good resistance to grease, mineral oils and many chemicals
Colour	black
Sizes	8 to 11
Order quantity multiples	10 PR

uvex u-chem 3500

- sensitive NBR broadband chemical protection glove (protection against 11 of 18 test chemicals). Material combination of nitrile and chloroprene protects against alcohols, aliphatic hydrocarbons, and concentrates acids and bases with a permeation time of ≥ 120 minutes.
- protection against contact heat 100 °C (Level 1)
- very good fit, very high wearing comfort thanks to seamless cotton liner

	uvex u-chem 3500
Art. no.	60188
Design	cuff, fully coated, approx. 32cm
Standard	EN ISO 374-1:2016 / Typ A (A C J K L M N O P S T), EN ISO 374-5:2016 VIRUS, EN 388 (3 12 1 X), EN 407 (X 1 X X X X)
Material	cotton (seamless)
Coating	fully coated with Chloroprene and NBR (nitrile butadiene rubber), approx. 0.40 mm
Suitable for	good resistance to acetone, cleaning agents, adhesives, solvents
Colour	orange
Sizes	7 to 11
Order quantity multiples	10 PR

Chemical Risks

Unsupported safety gloves



60122



60119

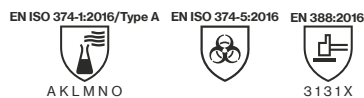

uvex profastrong

- sensitive NBR chemical protection glove with flocked cotton
- outstanding mechanical abrasion resistance
- good grip in damp and wet areas thanks to the Grip structure in the palm
- good resistance to many oils, grease, acids and alkalis
- good tactile feel
- good fit
- highly flexible

Art. no.	uvex profastrong NF33 60122
Design	gauntlet, palm with grip structure, approx. 33 cm
Standard	EN 388 (4 1 0 1 X), EN ISO 374-1:2016/Type A (A J K L O T), EN ISO 374-5:2016 VIRUS
Material	flocked cotton
Coating	fully coated with NBR (nitrile rubber), approx. 0.38 mm
Suitable for	good resistance to oils, grease, acids and solvents
Colour	green
Sizes	7 to 11
Order quantity multiples	12 PR

uvex profapren

- flexible chloroprene chemical protection glove with flocked cotton
- good grip in damp and wet areas thanks to the Grip structure in the palm
- good resistance to many chemicals and solvents
- good tactile feel
- very good fit
- highly flexible

Art. no.	uvex profapren CF33 60119
Design	gauntlet, roughened palm, approx. 33 cm
Standard	EN 388 (3 1 3 1 X), EN ISO 374-1:2016/Type A (A K L M N O), EN ISO 374-5:2016
Material	flocked cotton
Coating	fully coated with polychloroprene (latex inner), approx. 0.71 mm
Suitable for	good resistance to many chemicals
Colour	dark blue
Sizes	7 to 10
Order quantity multiples	10 PR



Chemical Risks

Disposable safety gloves

The uvex u-fit product range, provides high-quality disposable safety gloves, which guarantee a high level of safety and functionality.

uvex u-fit gloves ensures reliable wearer protection throughout industry, including the chemical, medical, food and light industry sectors enabling comfortable and precise work.

uvex disposable safety gloves are available in four different materials to cater for a wide range of application areas:

- uvex u-fit lite
- uvex u-fit
- uvex u-fit ft
- uvex u-fit strong N2000

	uvex u-fit lite	uvex u-fit	uvex u-fit ft	uvex u-fit strong N2000
Material	accelerator-free NBR (nitrile rubber)	NBR (nitrile rubber)	NBR (nitrile rubber)	NBR (nitrile rubber)
	wall thickness 0.06mm	wall thickness 0.10mm	wall thickness 0.10mm	wall thickness 0.20 mm
Certification	EN ISO 374	EN ISO 374	EN ISO 374	EN ISO 374
	EN 455	EN 455	EN 455	EN 455
	handling foodstuffs	handling foodstuffs	handling foodstuffs	handling foodstuffs
	compliance with MDR (EU) 2017/745	-	compliance with MDR (EU) 2017/745	-
Characteristics	high level of sensitivity	good mechanical abrasion resistance	good mechanical abrasion resistance	very good abrasion resistance
	hypo-allergenic	good chemical resistance	good chemical resistance	increased chemical resistance
Handling	reinforced rolled edge – easy to put on	reinforced rolled edge – easy to put on	reinforced rolled edge – easy to put on	reinforced rolled edge – easy to put on



Please contact us if you require a copy of our complete resistance list.

Detailed information can also be found in the uvex Chemical Expert System online at <https://ces.uvex.de>

Area of application	uvex u-fit lite	uvex u-fit	uvex u-fit ft	uvex u-fit strong N2000
Intended for medical examinations and to prevent infections between users and patients	++	-	++	-
Precision assembly work, dry/oily	++	+	+	-
Assembly work, dry/oily	+	+	+	++
Product protection	++	++	++	+
Gentle cleaning	+	+	+	++
Inspection	++	++	++	+
Food handling	+	+	+	+
Chemicals	short-term work, in acc. with resistance list	short-term work, in acc. with resistance list	short-term work, in acc. with resistance list	in acc. with resistance list
Paint shop	as splash protection	as splash protection	as splash protection	full contact in acc. with resistance list

Chemical Risks

Disposable safety gloves

Accelerator-free



60168



uvex u-fit lite

- nitrile examination and safety gloves single use (0.06 mm)
- non-sterile, can be used on both sides, powder-free
- free from natural latex
- free from allergenic accelerators.
- good grip with the roughened fingertips
- LABS-conformity in accordance with VDMA 24364 A2-L

EN ISO 374-1:2016 / Type B EN ISO 374-5:2016



	uvex u-fit lite
Art. no.	60168
Design	roughened fingertips, approx. 24 cm
Standard	EN ISO 374-1:2016/ Type B (K P T), EN 374-5:2016 VIRUS
Material	without stockinette
Coating	NBR (nitrile rubber), approx. 0.06 mm
Suitable for	highly resistant to grease and oil, good resistance to chemicals, for medical examinations and to prevent infections between users and patients
Colour	indigo blue
Sizes	S to XL
Order unit	BOX
Content	box of 100 PC



60167



uvex u-fit

- nitrile single-use safety gloves (0.10 mm)
- non-sterile, can be used on both sides, powder-free
- free from natural latex
- good grip with the roughened surface
- LABS-conformity in accordance with VDMA 24364 A2-L

EN ISO 374-1:2016 / Type B EN ISO 374-5:2016



	uvex u-fit
Art. no.	60167
Design	roughened surface, approx. 24 cm
Standard	EN ISO 374-1:2016/ Type B (K P T), EN 374-5:2016 VIRUS
Material	without stockinette
Coating	NBR (nitrile rubber), approx. 0.10 mm
Suitable for	highly resistant to grease and oil, good resistance to chemicals
Colour	blue
Sizes	S to XL
Order unit	BOX
Content	box of 100 PC



60166



uvex u-fit ft

- nitrile single-use examination and safety gloves (0.10 mm)
- non-sterile, can be used on both sides, powder-free
- free from natural latex
- good grip with the roughened fingertips
- LABS-conformity in accordance with VDMA 24364 A1/A2/A3 L/W

EN ISO 374-1:2016 / Type B EN ISO 374-5:2016



	uvex u-fit ft
Art. no.	60166
Design	roughened fingertips, approx. 24 cm
Standard	EN ISO 374-1:2016/ Type B (J K P T), EN 374-5:2016 VIRUS
Material	without stockinette
Coating	NBR (nitrile rubber), approx. 0.10 mm
Suitable for	highly resistant to grease and oil, good resistance to chemicals, for medical examinations and to prevent infections between users and patients
Colour	blue
Sizes	XS to XL
Order unit	BOX
Content	box of 100 PC



60962



uvex u-fit strong N2000

- nitrile single-use safety gloves (0.20 mm)
- non-sterile, can be used on both sides, powder-free
- free from natural latex
- good grip with the roughened fingertips
- LABS-conformity in accordance with VDMA 24364 A2-L/W

EN ISO 374-1:2016 / Type A EN ISO 374-5:2016



	uvex u-fit strong N2000
Art. no.	60962
Design	textured surface of fingertips, approx. 28 cm
Standard	EN ISO 374-1:2016/ Type A (J K L O P S T), EN 374-5:2016 VIRUS
Material	no lining
Coating	NBR (nitrile butadiene rubber), approx. 0.20 mm
Suitable for	highly resistant to grease and oil, increased resistance to chemicals
Colour	blue
Sizes	S to XXL
Order unit	BOX
Content	box of 50 PC



Safety Gloves

Needlestick

							
Page 264	Page 264	Page 264	Page 265	Page 265	Page 266	Page 266	Page 266
HexArmor PointGuard® Ultra 9032	HexArmor SharpsMaster II® 9014	HexArmor Armschutz AG8TW	HexArmor PointGuard® Ultra 4045	HexArmor Hercules® NSR 3041	HexArmor Helix® 2082	HexArmor Helix® 3023	HexArmor Helix® 2076

Cut protection

Cut protection

								
Page 267	Page 267	Page 267	Page 268	Page 268	Page 268	Page 269	Page 269	Page 269
HexArmor Helix® 2065	HexArmor Helix® 3070	HexArmor Helix® 3071	HexArmor Helix® 3033	HexArmor Helix® 2062	HexArmor Chrome SLT® 4062	HexArmor Chrome Series® 4023M	HexArmor ThornArmor 3092	HexArmor Armschutz AG10009S

Cut protection

Impact

								
Page 270	Page 270	Page 270	Page 271	Page 271	Page 271	Page 272	Page 272	Page 272
HexArmor 9000 Series 9013	HexArmor Chrome SLT 4070	HexArmor Thin Lizzie™ Thermal 2099	HexArmor Helix® 1095	HexArmor Rig Lizard® 7101	HexArmor Thin Lizzie™ Fluid 7102	HexArmor Helix® 3000	HexArmor Helix® 3003	HexArmor Helix® 3007

Impact

					
Page 273	Page 273	Page 273	Page 274	Page 274	Page 274
HexArmor Thin Lizzie™ 2090X	HexArmor Thin Lizzie™ 2095	HexArmor Rig Lizard® 2038	HexArmor Rig Lizard® 2021X	HexArmor Rig Lizard® 2039	HexArmor Chrome 4026

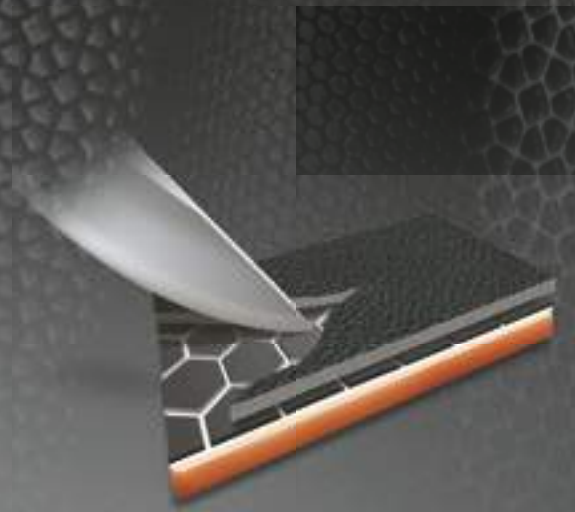

A Cut Above

HexArmor® is an exclusive licensee of SuperFabric® brand material in the industrial PPE market. HexArmor® products with SuperFabric® brand material have a secret weapon against cut hazards that no other glove can boast. SuperFabric® technology is designed to prevent lacerations and slashes from reaching the skin. Performance is enhanced through the configuration of tiny guard plates.

Impact Resistance

Impacts come in all forms, shapes, and magnitudes for workers. Whether caused by falling tools, equipment or pinches, impact injuries have one thing in common: unpredictability. Individuals must always be prepared and protected from impact and pinch points, and the patented IR-X® Impact Exoskeleton™ from HexArmor® has proven to reduce the number and effects of injuries.

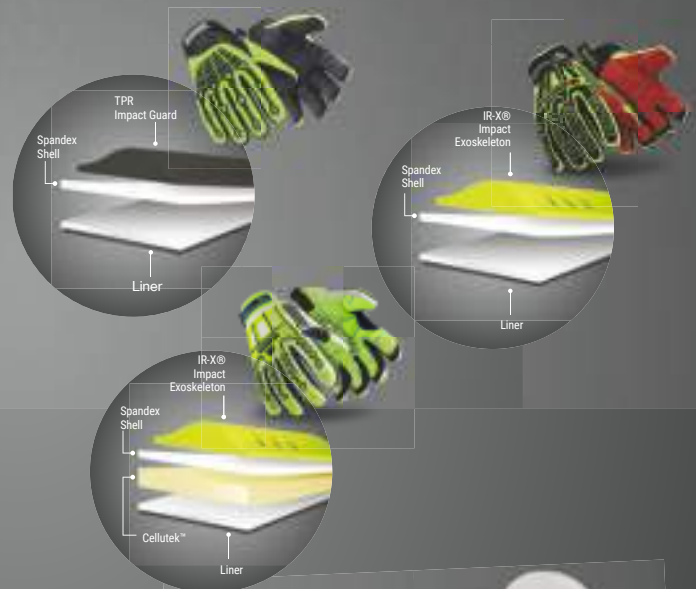

Needlestick Resistance

Needles are sharp, beveled cutting instruments designed to pierce the skin. HexArmor® needle resistant products work by layering SuperFabric® brand materials over each other. SuperFabric® brand material guardplates block and deflect needle hazards or trap and arrest them in the small gaps found between guardplates. Multiple aligned layers of fabric provide extra resistance against needle hazards.

HexArmor® products are tested in real world applications and are proven to reduce needlesstick injuries. Using the correct test will ensure you have the right glove to protect your employees. As always, we recommend proper field testing to validate the appropriate level of protection necessary for your application.



Two brands with one global mission:
protecting people
HexArmor® + uvex

uvex and HexArmor® – two brands with one global mission: protecting people. We now offer a select range of safety gloves from HexArmor's portfolio to all uvex customers in the Eastern Hemisphere (Europe, Africa, Middle East and Russia). View the HexArmor® safety gloves range at www.uvex-safety.com/en/hexarmor



Detailed information can be found at <https://www.uvex-safety.com/en/hexarmor>



Cut resistance: Comparison between EN 388-2016 and ANSI/ISEA 105-2016

When comparing the cut resistance of two or more fabrics, it is important to make sure that for all materials:

- **The same test method was used**
- **The same type of cut tester was used**

Unless these points are met, you cannot accurately compare the results.

Cut resistance levels: The use of the TDM-100 test method is required by both ANSI/ISEA 105 and by EN 388 (for high-cut materials). However, the ANSI/ISEA standard reports results in grams on an A1-A9 scale (200-6000 grams/2-60 Newtons). While the A1-A9 scale is comparable to the EN 388 A-F levels which reports up to 30 Newtons (200-3000 grams/2-30 Newtons), ANSI/ISEA extends their scale by three levels to 6000 grams/60 Newtons to report high cut materials more accurately.

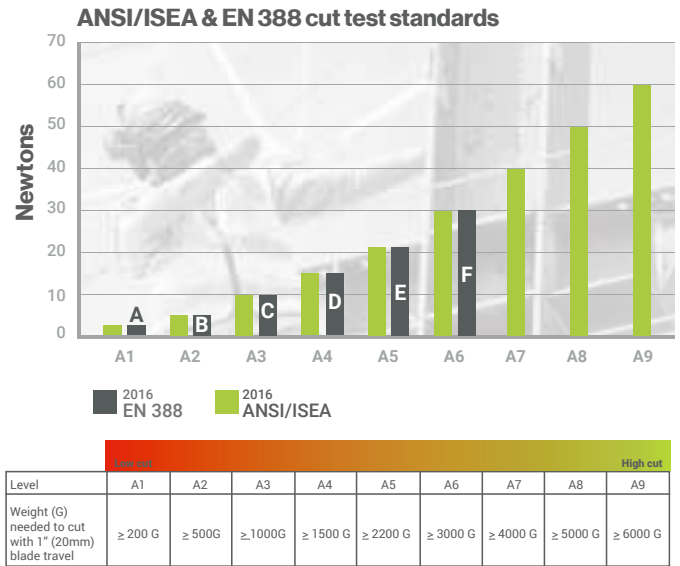

Puncture & Needle Testing Explained

The ANSI/ISEA 105 Test

In February of 2016, the ANSI/ISEA 105 standard was updated and published to include two puncture standards: Puncture Resistance (other than hypodermic needle) and Hypodermic Needlestick Puncture. Prior to 2015, there was only one puncture test, which did not specify the type of puncture hazard the standard was created for, leaving it open for interpretation. Having both an industrial puncture standard and a hypodermic needle puncture standard allows safety managers to differentiate between what protection they need most, based on more relevant testing and classification.

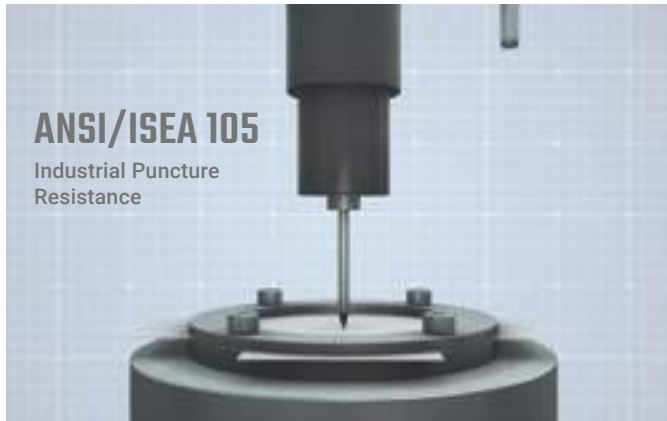

EN 388: Industrial Puncture Resistance (Non-Hypodermic Needlestick Puncture)

The EN 388 probe is the approved puncture test for ANSI/ISEA 105 and measures the amount of force needed for a blunt probe to pierce through the sample material (taken from palm).

- The blunt probe moves at a 90° angle at a speed of 100mm/minute
- Results are reported in Newtons and are given a 1-5 classification rating, with 1 being low resistance and 5 being high resistance
- The test is done 4 times for every palm sample
- The lowest score is reported



ASTM F2878: Hypodermic Needlestick Puncture Resistance

The ASTM F2878 is the approved puncture test for ANSI/ISEA 105 and measures the amount of force needed for a 25-gauge hypodermic needle to pierce through the sample material.

- The puncture probe (25-gauge needle) travels at a 90° angle into specimen at a vector of 500 millimeters per minute.
- Results are reported in Newtons and are giving a 1-5 classification rating, with 1 being low resistance and 5 being high resistance
- The test is done 12 times for every palm sample
- The average of the 12 results is reported

Impact protection

Back-of-hand bones and soft tissues are extremely vulnerable to impact-related hand injuries among a wide range of job sites. This U.S.-based impact performance standard will help safety professionals make better-informed decisions about glove selection – ultimately keeping more people safe on the job.

Impact protection: ANSI/ISEA 138

The ISEA 138 standard establishes the minimum performance, classification, and labeling requirements for gloves that are designed to protect the knuckles and fingers from impacts based on three performance levels.

How the test works: To score gloves into their appropriate level, impact protection testing under ISEA 138 requires consistent, regulated tests on each kind of glove on two areas for impact performance: knuckles and fingers/thumb. On both gloves, knuckles are tested four times and fingers/thumb are tested five times.

To start, one pair of gloves is required per test. The gloves are cut in half and the back-of-hand (where the impact protection is located) is placed on an anvil. A striker with a force of 5 Joules is dropped on the required back-of-hand locations, and the amount of force transferred through the glove back-of-hand is recorded with a force gauge that is connected below the anvil and measured in kiloNewtons (kN).

Scoring: The average of eight knuckle tests are compared to the average of the ten finger tests. The highest average of the two is the impact testing score.

- **Performance Level 1** – Results in an average peak transmitted force of less than or equal to 9 kN.
 - 55% of force absorbed
- **Performance Level 2** – Results in an average peak transmitted force of less than 6.5 kN.
 - 67.5% of force absorbed
- **Performance Level 3** – Results in an average peak transmitted force of less than 4 kN.
 - 80% of force absorbed

The chart showcases the ISEA 138 performance levels, with "Performance Level 3" being the highest. Any impact-resistant PPE that scores higher than a 9 kN force transfer will not qualify for a ranking and will fail. With no impact material, the machine registers around 20kN, so in order to pass the test, the impact material must register less than 9kN, reducing the force or energy transferred by 55%. The anvil will drop roughly around 5 ½ pounds from 8 inches.

Impact protection: EN 388

The European industrial glove market includes impact testing performance ratings in EN 388, which tests the impact on just the knuckles, and the tests are given a basic score of pass or fail. To pass the test, the transmitted force needs to be less than or equal to 7 kN with no single results greater than 9 kN.

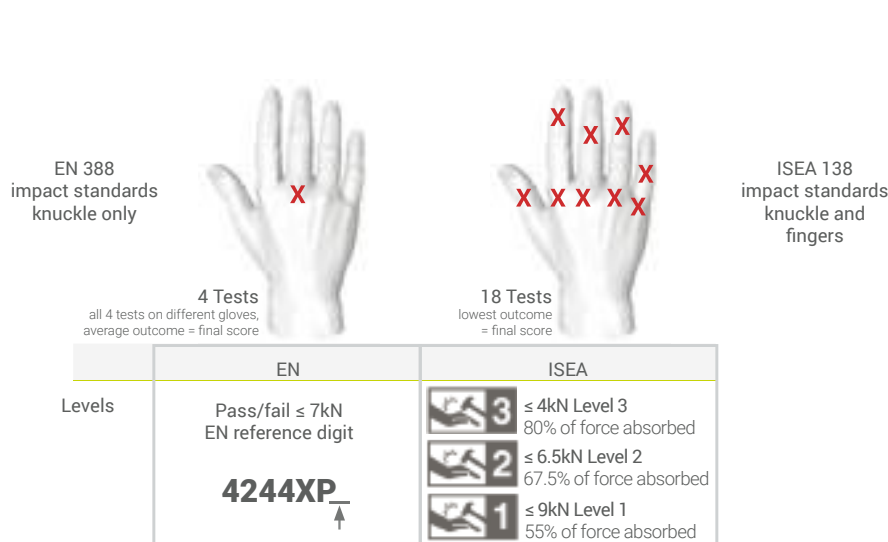

Needlestick Series



60638



60982



60981



	3 Layers SuperFabric® Protection	ANSI/ISEA CUT	GRAM SCORE	ANSI/ISEA PUNCTURE
		A9	7167	4
	NEEDESTICK LEVEL 5	NEWTONS 11.143		

	3 Layers SuperFabric® Protection	ANSI/ISEA CUT	GRAM SCORE	ANSI/ISEA PUNCTURE
		A9	7167	5
	NEEDESTICK LEVEL 5	NEWTONS 10.279		

	2 Layers SuperFabric® Protection	ANSI/ISEA CUT	GRAM SCORE	ANSI/ISEA PUNCTURE
		A8	5254	2
	NEEDESTICK LEVEL 2	NEWTONS 5.5125		

9032

Article No. 60638

PointGuard® Ultra

- SuperFabric® brand material provides industry-leading needlestick resistance (in noted enhanced areas)
- Single-glove needle solution with incredible dexterity and comfort
- Sandy nitrile three-quarter knuckle coating

9014

Article No. 60981

SharpsMaster II®

- SuperFabric® brand material provides industry-leading needlestick resistance (in noted enhanced areas)
- Cotton blend shell provides exceptional dexterity and feel
- Wrinkle rubber latex palm coating

AG8TW

Article No. 60982

Arm Guard

- SuperFabric® brand material provides industry-leading needlestick resistance
- Won't fall down like knit sleeves
- Spandex wrist insert with thumb hole and snap fasteners

	PointGuard® Ultra 9032
Article No.	60638
Standard	EN 388: 2016 (4 X 4 3 F)
Colour	yellow/blue
Sizes	7/S through 11/XXL
Order quantity multiples	1 PR

	SharpsMaster II® 9014
Article No.	60981
Standard	EN 388: 2016 (4 X 4 4 F)
Colour	white/orange
Sizes	6/XS through 10/XL
Order quantity multiples	1 PR

	AG8TW Arm Guard
Article No.	60982
Standard	EN 388: 2016 (4 X 1 1 F)
Colour	black
Sizes	7/S through 12/3XL
Order quantity multiples	1 PC

Needlestick Series



60005



60983



	2 Layers SuperFabric® Protection	ANSI/ISEA CUT	GRAM SCORE	ANSI/ISEA PUNCTURE
	SuperFabric® Protection Zone	A7	4321	3
		NEEDLESTICK	NEWTONS	
	LEVEL 2 SuperFabric®	5.284	5.284	5.284
	LEVEL 3 2 Layers SuperFabric®	6.9	6.9	6.9

	3 Layers SuperFabric® Protection	ANSI/ISEA CUT	GRAM SCORE	ANSI/ISEA PUNCTURE
	2 Layers SuperFabric® Protection	A9	8668	3
		NEEDLESTICK	NEWTONS	
	LEVEL 5	11.59	11.59	11.59



4045

Article No. 60005

PointGuard® Ultra

- SuperFabric® brand material provides industry-leading needlestick resistance (in noted enhanced areas)
- Back-of-hand knuckle padding for incidental bumps/impact
- Silicone palm pattern for enhanced grip
- Neoprene cuff with Velcro® closure

3041

Article No. 60983

Hercules® NSR

- SuperFabric® brand material provides industry-leading needlestick resistance (in noted enhanced areas)
- Full coverage design and pre-curved shape for maximum comfort and protection
- Silicone dot palm grip

	PointGuard® Ultra 4045
Article No.	60005
Standard	EN 388: 2016 (4 X 2 2 F)
Colour	black
Sizes	6/XS through 12/3XL
Order quantity multiples	1 PR

	Hercules® NSR 3041
Article No.	60983
Standard	EN 388: 2016 (4 X 1 2 F)
Colour	black
Sizes	7/S through 11/XXL
Order quantity multiples	1 PR

Cut protection Series



60614



60660



60683

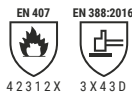

4 2 3 1 2 X 3 X 4 3 D



4 X 4 3 D



4 X 4 4 F

Aramid Blend Shell	ANSI/ISEA CUT	GRAM SCORE	ANSI/ISEA PUNCTURE
	A3	1147	4

HPPE Blend Shell	ANSI/ISEA CUT	GRAM SCORE	ANSI/ISEA PUNCTURE
	A5	2396	4

HPPE Blend Shell	ANSI/ISEA CUT	GRAM SCORE	ANSI/ISEA PUNCTURE
	A6	3276	5

2082

Article No. 60614

Helix®

- 13-gauge flame-resistant aramid and wool blend shell*
- Flexible FR-compliant neoprene/nitrile blend palm coating

*Hazard risk category HRC 1 arc flash protection (ATPV 7.7 cal/cm², as per ASTM F2675/F2675M-13, determining arc flash rating of hand-protective devices)

Helix® 2082	
Article No.	60614
Standard	EN 388: 2016 (3 X 4 3 D), EN 407 (4 2 3 1 2 X)
Colour	green mottled/black
Sizes	7/S through 11/XXL
Order quantity multiples	1 PR

3023

Article No. 60683

Helix®

- 15-gauge HPPE, steel, polyester mixed fabric
- Excellent mechanical abrasion resistance thanks to the robust and grippy nitrile foam coating
- Reinforcement on the thumb crotch
- Touchscreen capability

Helix® 3023	
Article No.	60683
Standard	EN 388: 2016 (4 X 4 3 D)
Colour	blue mottled/black
Sizes	6/XS through 11/2XL
Order quantity multiples	1 PR

2076

Article No. 60660

Helix®

- 13-gauge HPPE, steel, and fiberglass blend shell
- Flexible polyurethane palm coating
- Reinforced thumb crotch patch

Helix® 2076	
Article No.	60660
Standard	EN 388: 2016 (4 X 4 4 F)
Colour	blue mottled/black
Sizes	5/XXS through 13/4XL
Order quantity multiples	1 PR

Cut protection Series



60684



60659



60685



4 X 4 2 D

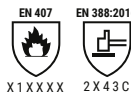

X 1 X X X X 2 X 4 3 C

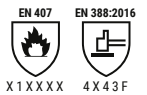

X 1 X X X X 4 X 4 3 F

HPPE Blend Shell	ANSI/ISEA CUT	GRAM SCORE	ANSI/ISEA PUNCTURE
	A3	1274	3

HPPE Blend Shell	ANSI/ISEA CUT	GRAM SCORE	ANSI/ISEA PUNCTURE
	A2	809	4

HPPE Blend Shell	ANSI/ISEA CUT	GRAM SCORE	ANSI/ISEA PUNCTURE
	A6	3711	4



2065

Article No. 60659

Helix®

- 13-gauge HPPE and fiberglass shell
- Flexible sandy nitrile palm coating
- Full flat nitrile coating offers 360° water resistance

3070

Article no. 60684

Helix®

- 18-gauge HPPE/fibreglass mixed fabric
- Fully coated with natural latex, this model offers 360° water resistance
- Coated knitted cuff helps to prevent the ingress of liquids and dirt into the glove

3071

Article no. 60685

Helix®

- 13-gauge HPPE/steel mixed fabric
- Fully coated with natural latex, this model offers 360° water resistance
- Coated knitted cuff helps to prevent the ingress of liquids and dirt into the glove
- Highest cut protection level F (according to EN388:2016)

	Helix® 2065
Article No.	60659
Standard	EN 388: 2016 (4 X 4 2 D)
Colour	blue/black
Sizes	6/XS through 12/3XL
Order quantity multiples	1 PR

	Helix® 3070
Article No.	60684
Standard	EN 388: 2016 (2 X 4 3 C), EN 407 (X 1 X X X X)
Colour	blue/black
Sizes	7/S through 11/2XL
Order quantity multiples	1 PR

	Helix® 3071
Article No.	60685
Standard	EN 388: 2016 (4 X 4 3 F), EN 407 (X 1 X X X X)
Colour	blue/black
Sizes	7/S through 11/2XL
Order quantity multiples	1 PR

Cut protection Series



60668



60655



60661

EN 388:2016
3 X 4 1 E

HPPE Blend Shell	ANSI/ISEA CUT A6	GRAM SCORE 3825	ANSI/ISEA PUNCTURE 4
------------------	----------------------------	---------------------------	--------------------------------

EN 388:2016
4 X 4 4 F

Coretex™ Shell	ANSI/ISEA CUT A9	GRAM SCORE 6437	ANSI/ISEA PUNCTURE 5
----------------	----------------------------	---------------------------	--------------------------------

EN 407
4 2 2 1 4 1

EN 388:2016
2 X 2 3 E

Aramid Liner	ANSI/ISEA CUT A5	GRAM SCORE 2509	ANSI/ISEA PUNCTURE 4
--------------	----------------------------	---------------------------	--------------------------------

3033

Article No. 60668

Helix®

- Engineered knit to specifically prevent glove particles from contacting food (outer layer tested to FDA 21 CFR 177.1630 for food safe contact)
- Seamless construction for enhanced comfort and breathability
- Can be used in direct contact with food or as an underglove with appropriate top-glove solution

	Helix® 3033
Article No.	60668
Standard	EN 388: 2016 (3 X 4 1 E)
Colour	mottled blue
Sizes	6/XS through 11/2XL
Order quantity multiples	1 PR

2062

Article No. 60661

Helix®

- Coretex™ (13G HPPE, steel, and fiberglass blend) shell for industry-leading 360° cut resistance
- Flexible sandy nitrile palm coating
- Hi-vis color on back-of-hand

	Helix® 2062
Article No.	60661
Standard	EN 388: 2016 (4 X 4 4 F)
Colour	yellow/black
Sizes	6/XS through 12/3XL
Order quantity multiples	1 PR

4062

Article No. 60655

Chrome SLT®

- Arc Flash Level 4 Rating: Lab tested in accordance with HRC ATPV at 46 Cal/cm²
- Goatskin leather palm provides a traditional style of comfort and grip
- Stitched with Aramid thread
- Full aramid liner for 360° cut protection
- Extended safety cuff for easy on and off

	Chrome SLT® 4062
Article No.	60655
Standard	EN 388: 2016 (2 X 2 3 E), EN 407 (4 2 2 1 4 1)
Colour	beige
Sizes	6/XS through 12/3XL
Order quantity multiples	1 PR

Cut protection Series



60010



60673



60985



SuperFabric®
Protection Zone

ANSI/ISEA CUT	GRAM SCORE	ANSI/ISEA PUNCTURE
A8	5374	2



3 Layers
SuperFabric® Protection

ANSI/ISEA CUT	GRAM SCORE	ANSI/ISEA PUNCTURE
A3	1274	3



NEEDLESTICK	NEWTONS
LEVEL 5	11.94

SuperFabric®
Protection Zone

ANSI/ISEA CUT	GRAM SCORE	ANSI/ISEA PUNCTURE
A7	4425	3



ANSI/ISEA ABRASION	ANSI/ISEA CONTACT HEAT
6	2



4023M

Article No. 60673

Chrome

- SuperFabric® brand material provides 360° industry-leading cut resistance (interior layer)
- Durable TP-X® palm
- Elastic cuff with Velcro® closure

Chrome 4023M	
Article No.	60673
Standard	EN 388: 2016 (4 X 4 1 F)
Colour	grey/green
Sizes	7/S through 12/3XL
Order quantity multiples	1 PR

3092

Article No. 60010

ThornArmor 3092

- Three layers of SuperFabric®** brand material in the palm and partial index finger wrap provides industry-leading cut resistance (interior layer)
- Breathable HexVent® panel on the back-of-hand helps keep you cool
- Airprene cuff with Velcro® closure for a secure fit
- Durable TP-X® palm provides superior grip and abrasion resistance

HexArmor ThornArmor 3092	
Article No.	60010
Standard	EN 388: 2016 (4 X 3 3 F)
Colour	brown/black
Sizes	5/XXS through 11/2XL
Order quantity multiples	1 PR

AG10009S

Article No. 60985

Arm Guard AG10009S

- The SuperFabric® brand material provides industry-leading cut resistance
- Industrial puncture protection in exposed areas to help protect against injuries caused by cables, metal, wood and glass
- Elastane insert on wrist with thumb hole

Arm Guard AG10009S	
Article No.	60985
Standard	EN 388: 2016 (4 X 4 2 F)
Colour	black/neon-yellow
Sizes	6/XS through 12/3XL
Order quantity multiples	1 PC

Cut protection Series/Impact Series



60984



60646



60609







EN 388:2016 4 X 4 3 F	ANSI/ISEA CUT A8	GRAM SCORE 5022	ANSI/ISEA PUNCTURE 4
--------------------------	----------------------------	---------------------------	--------------------------------







EN 388:2016 4 X 4 1 F P	ANSI/ISEA CUT A6	GRAM SCORE 3685	ANSI/ISEA PUNCTURE 2
----------------------------	----------------------------	---------------------------	--------------------------------



EN 511 12 X	EN 388:2016 4 X 4 3 E P	ANSI/ISEA CUT A6	GRAM SCORE 3132	ANSI/ISEA PUNCTURE 4
----------------	----------------------------	----------------------------	---------------------------	--------------------------------



9013

Article No. 60984

9000 Series 9013

- SuperFabric® brand materials provide industry-leading cut resistance (interior layer)
- HPPE and fiberglass blend shell
- Abrasion-resistant sandy nitrile palm coating

4070

Article No. 60609

Chrome SLT 4070

- HPPE blend liner provides 360° industry-leading cut resistance (interior layer)
- Back-of-hand impact guards provide ANSI/ISEA 138 Level 1 protection on knuckles and fingers
- Synthetic leather palm with abrasion-resistant PVC dots
- Hi-vis color on back-of-hand
- Elastic cuff with Velcro® closure for a secure fit, Pull tab

2099

Article No. 60646

Thin Lizzie™ Thermal

- Back-of-hand IR-X® Impact Exoskeleton™ with high-flex design provides ANSI/ISEA 138 Level 2 protection on knuckles and Level 1 protection on fingers
- 13-gauge acrylic and fiberglass blend shell offers 360° cut resistance
- Sandy nitrile full coating provides superior grip
- Full double-dipped coating offers liquid resistance
- Interior fleece lining for warmth

9000 Series 9013	
Article No.	60984
Standard	EN 388: 2016 (4 X 4 3 F)
Colour	mottled grey/black
Sizes	7/S through 11/2XL
Order quantity multiples	1 PR

Chrome SLT 4070	
Article No.	60609
Standard	EN 388: 2016 (4 X 4 1 F P)
Colour	orange/grey
Sizes	6/XS through 12/3XL
Order quantity multiples	1 PR

Thin Lizzie™ Thermal 2099	
Article No.	60646
Standard	EN 388: 2016 (4 X 4 3 E P), EN 511 (1 2 X)
Colour	yellow/black/red
Sizes	6/XS through 11/XXL
Order quantity multiples	1 PR

Impact Series



60651



60652



60642

EN 388:2016
4 1 2 1 X P

Impact Protection	ANSI/ISEA CUT	GRAM SCORE	ANSI/ISEA PUNCTURE
Nylon Blend Shell	A1	255	2
	ANSI/ISEA 138		1

EN 388:2016
4 1 2 1 X P

Impact Protection	ANSI/ISEA CUT	GRAM SCORE	ANSI/ISEA PUNCTURE
	A1	257	2
	ANSI/ISEA 138		1

EN 388:2016
4 X 4 2 C P

Impact Protection	ANSI/ISEA CUT	GRAM SCORE	ANSI/ISEA PUNCTURE
HPPE Blend Shell	A4	1274	3
	ANSI/ISEA 138		1

1095

Article No. 60642

Helix®

- High-performance 15-gauge nylon blend shell
- Flexible sandy nitrile palm coating
- Back-of-hand IR-X® Impact Exoskeleton™ with high-flex design provides ANSI/ISEA 138 Level 1 protection on knuckles and fingers

7101

Article No. 60651

Rig Lizard 7101

- Back-of-hand IR-X® Impact Exoskeleton™ with high-flex design provides ANSI/ISEA 138 Level 2 protection on knuckles and Level 1 protection on fingers
- Sandy nitrile full coating provides superior grip and abrasion resistance
- Full double dip for fluid/water resistance

7102

Article No. 60652

Thin Lizzie™ Fluid

- Back-of-hand IR-X® Impact Exoskeleton™ with high-flex design provides ANSI/ISEA 138 Level 2 protection on knuckles and Level 1 protection on fingers
- 13-gauge HPPE and fiberglass blend shell
- Sandy nitrile full coating
- Full double-dipped coating offers liquid resistance

	Helix® 1095
Article No.	60642
Standard	EN 388: 2016 (4 1 2 1 X P)
Colour	grey/black/yellow
Sizes	6/XS through 12/3XL
Order quantity multiples	1 PR

	Rig Lizard 7101
Article No.	60651
Standard	EN 388: 2016 (4 1 2 1 X P)
Colour	yellow/blue
Sizes	6/XS through 12/3XL
Order quantity multiples	1 PR

	Thin Lizzie™ Fluid 7102
Article No.	60652
Standard	EN 388: 2016 (4 X 4 2 C P)
Colour	blue/yellow
Sizes	6/XS through 12/3XL
Order quantity multiples	1 PR



Impact Series



60662



60666



60665

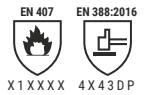
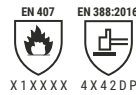

Impact Protection
HPPE Blend Shell

ANSI/ISEA PUNCTURE
3

Impact Protection
HPPE Blend Shell

ANSI/ISEA PUNCTURE
3

Impact Protection
HPPE Blend Shell

ANSI/ISEA PUNCTURE
3

3000

Article No. 60662

Helix®

- 13-gauge HPPE and fiberglass shell
- Flexible sandy nitrile palm coating
- Back-of-hand IR-X® Impact Exoskeleton™ with high-flex design
- Reinforced thumb crotch patch

Helix® 3000	
Article No.	60662
Standard	EN 388: 2016 (4 X 4 2 D P)
Colour	yellow/black
Sizes	6/XS through 12/3XL
Order quantity multiples	1 PR

3003

Article No. 60665

Helix®

- 13-gauge HPPE and steel shell
- Flexible sandy nitrile palm coating
- Back-of-hand IR-X® Impact Exoskeleton™ with high-flex design
- Reinforced thumb crotch patch
- Elastic cuff with Velcro® closure

Helix® 3003	
Article No.	60665
Standard	EN 388: 2016 (4 X 4 2 D P), EN 407 (X 1 X X X X)
Colour	black/black
Sizes	7/S through 11/XXL
Order quantity multiples	1 PR

3007

Article No. 60666

Helix®

- IR-X® Impact Exoskeleton™ with high-flex de
- velcro closure for a good fitting
- High-performance polyethylene and glass fiber
- exceptional dexterity and feel
- Reinforced thumb crotch patch
- Sandy nitrile palm coating

Helix® 3007	
Article No.	60666
Standard	EN 388: 2016 (4 X 4 3 D P), EN 407 (X 1 X X X X)
Colour	red/yellow/black/grey
Sizes	6/XS through 12/3XL
Order quantity multiples	1 PR

Impact Series



60650



60648



60681

Impact Protection
 HPPE Blend Shell
 ANSI/ISEA CUT
 GRAM SCORE
 ANSI/ISEA PUNCTURE
 ANSI/ISEA 138

A4
2053
5
1

EN 388:2016
4 X 4 4 EP

Impact Protection
 HPPE Blend Shell
 ANSI/ISEA CUT
 GRAM SCORE
 ANSI/ISEA PUNCTURE
 ANSI/ISEA 138

A6
3276
5
2

EN 388:2016
4 X 4 4 FP

Impact Protection
 TP-X® Technology
 ANSI/ISEA CUT
 GRAM SCORE
 ANSI/ISEA PUNCTURE
 ANSI/ISEA 138

A2
791
4
2

EN 407
 EN 388:2016
X2 XXXX **4 X 4 3 BP**

2090X

Article No. 60648

Thin Lizzie™

- Back-of-hand IR-X® Impact Exoskeleton™ with high-flex design provides ANSI/ISEA 138 Level 2 protection on knuckles and Level 1 protection on fingers
- 13-gauge HPPE and glass fiber blend shell provides exceptional dexterity and feel
- Sandy nitrile palm coating
- Reinforced thumb crotch patch
- Protected by U.S. Patent No. D703,389

Thin Lizzie™ 2090X	
Article No.	60648
Standard	EN 388: 2016 (4 X 4 4 E P)
Colour	grey/yellow
Sizes	5/XXS through 12/3XL
Order quantity multiples	1 PR

2095

Article No. 60650

Thin Lizzie™

- Back-of-hand IR-X® Impact Exoskeleton™ with high-flex design provides ANSI/ISEA 138 Level 2 protection on knuckles and Level 1 protection on fingers
- 13-gauge HPPE, steel, and fiberglass blend shell
- Polyurethane palm coating
- Reinforced thumb crotch patch

Thin Lizzie™ 2095	
Article No.	60650
Standard	EN 388: 2016 (4 X 4 4 F P)
Colour	blue/black/yellow
Sizes	5/XXS through 12/3XL
Order quantity multiples	1 PR

2038

Article No. 60681

Rig Lizard 2038

- Back-of-hand sewn-on IR-X® Impact Exoskeleton™ with high-flex design provides ANSI/ISEA 138 Level 2 protection on knuckles and fingers
- Reinforced TP-X® index finger and thumb saddle
- MudGrip+ palm: Synthetic leather with abrasion resistant PVC dots
- Elastic cuff with Velcro® closure for a secure fit, Pull tab loop

Rig Lizard 2038	
Article No.	60681
Standard	EN 388: 2016 (4 X 4 3 B P), 407 (X2 XXXX)
Colour	red/yellow
Sizes	6/XS through 12/3XL
Order quantity multiples	1 PR



Impact Series



60670



60986



60682

	X2XXXX	4X43CP	
	A3	1074	4
	2		

	X2XXXX	4X43EP	
	A6	3472	4
	2		

			4X21FP
	A8	5486	2
	1		

2021X

Article No. 60670

Rig Lizard®

- Back-of-hand IR-X® Impact Exoskeleton™ with high-flex design provides ANSI/ISEA 138 Level 1 protection on knuckles and fingers
- Additional IR-X® guard between thumb and index finger
- Durable TP-X® palm with reinforced stitching
- SlipFit® cuff with pull tab
- Protected by patents and patents pending

Rig Lizard® 2021X	
Article No.	60670
Standard	EN 388:2016 (4X43CP), EN 407 (X2XXXX)
Colour	yellow/black/red
Sizes	6/XS through 12/3XL
Order quantity multiples	1 PR

2039

Article No. 60682

Rig Lizard 2039

- Back-of-hand sewn-on IR-X® Impact Exoskeleton™ with high-flex design provides ANSI/ISEA 138 Level 2 protection on knuckles and fingers
- Reinforced TP-X® index finger and thumb saddle
- MudGrip+ palm: Synthetic leather with abrasion resistant PVC dots
- Elastic cuff with Velcro® closure for a secure fit, Pull tab loop

Rig Lizard 2039	
Article No.	60682
Standard	EN 388:2016 (4X43EP), 407 (X2XXXX)
Colour	red/yellow
Sizes	6/XS through 12/3XL
Order quantity multiples	1 PR

4026

Artikel-Nr: 60986

Chrome 4026

- SuperFabric® brand materials provide industry-leading cut resistance (interior layer)
- Back-of-hand impact guards provide ANSI/ISEA 138 Level 1 protection on knuckles and fingers
- Synthetic leather palm with abrasion-resistant PVC dots
- Hi-vis color and reflective tape on back-of-hand
- Elastic cuff with Velcro® closure for a secure fit

Chrome 4026	
Article No.	60986
Standard	EN 388:2016 (4X21FP)
Colour	black/neon-yellow
Sizes	6/XS through 12/3XL
Order quantity multiples	1 PR

Safety Gloves

Overview

Art. no.	Art. code	Sizes	Colour	Page
60027	uvex athletic lite	6 to 12	blue, anthracite	220
60028	uvex athletic allround	6 to 11	grey, anthracite	219
60030	uvex athletic D5 XP	6 to 12	grey, anthracite	245
60033	uvex athletic lite dry	6 to 12	blue, anthracite	220
60036	uvex athletic B XP	6 to 12	grey, anthracite	244
60037	uvex athletic C XP	6 to 12	grey, anthracite	245
60038	uvex phynomic airLite A ESD	5 to 12	black	215
60040	uvex phynomic lite	5 to 12	grey, grey	218
60041	uvex phynomic lite w	5 to 12	white, white	218
60048	uvex phynomic C XG ESD	6 to 12	light blue	243
60049	uvex phynomic allround	5 to 12	grey, black	215
60050	uvex phynomic foam	5 to 12	white, grey	215
60054	uvex phynomic x-foam HV	6 to 12	orange, grey	216
60060	uvex phynomic wet	6 to 12	blue, anthracite	216
60061	uvex phynomic wet plus	6 to 12	blue, anthracite	216
60062	uvex phynomic pro	6 to 12	blue, anthracite	217
60064	uvex phynomic pro 2	5 to 12	blue, anthracite	217
60070	uvex phynomic XG planet	5 to 12	black, black	214
60080	uvex phynomic B foam	6 to 12	sky blue	241
60081	uvex phynomic C5	6 to 12	blue, grey	242
60090	uvex BambooTwinflex®	6 to 12	green, black	235
60119	uvex profapren CF33	7 to 10	dark blue	257
60122	uvex profastrong NF33	7 to 11	green	257
60135	uvex unigrip 6620	7 to 10	white, blue	223
60147	uvex profi ergo ENB20A	6 to 11	white, orange	226
60148	uvex profi ergo ENB20	6 to 10	white, orange	226
60150	uvex contact ergo	6 to 10	white, orange	226
60179	uvex k-basic extra 6658	8, 10, 12	yellow	259
60166	uvex u-fit ft	XS to XL	blue	259
60167	uvex u-fit	S to XL	blue	259
60168	uvex u-fit lite	S to XL	indigo blue	228
60188	uvex u-chem 3500	7 to 11	orange	256
60190	uvex rubiflex S NB80S	9 to 11	green	252
60191	uvex rubiflex S NB80SZ	9 to 11	green	252
60202	uvex NK4022	9 to 10	orange	228
60208	uvex profi ergo XG20	6 to 11	white, orange, black	225
60210	uvex unidur 6641	6 to 11	white, grey	246
60213	uvex NK2722	9 to 10	orange	228
60224	uvex rubiflex S NB35B	7 to 11	blue	251
60238	uvex unigrip 6624	7 to 10	grey, red	223
60248	uvex unipur 6639	6 to 11	black, black	222
60271	uvex rubiflex S NB27B	7 to 11	blue	251
60276	uvex rubipor XS2001	6 to 10	white, white	219
60278	uvex unilite 7710F			227
60314	uvex unidur 6643	7 to 10	mottled grey, black	247
60316	uvex rubipor XS5001B	6 to 10	white, blue	219
60321	uvex unipur 6634	7 to 10	grey, black	221
6047900	uvex glove clip	-	black	218

Art. no.	Art. code	Sizes	Colour	Page
60491	uvex C500 sleeve	M, L	lime	237
60492	uvex C500 wet	7 to 11	lime, anthracite	238
60494	uvex C500 foam	7 to 11	lime, anthracite	238
60496	uvex C500 wet plus	7 to 11	lime, anthracite	237
60497	uvex C500	7 to 11	lime	237
60498	uvex C500 M foam	7 to 11	lime, black, anthracite	236
60499	uvex C500 dry	7 to 11	lime, anthracite	238
60516	uvex unidur 6649	7 to 11	mottled grey, grey	246
60535	uvex protector chemical NK2725B	9 to 10	blue	253
60536	uvex protector chemical NK4025B	9 to 10	blue	253
60542	uvex C300 wet	7 to 11	anthracite	239
60544	uvex C300 foam	7 to 11	anthracite	239
60549	uvex C300 dry	7 to 11	anthracite	239
60556	uvex unipur carbon	6 to 10	grey	223
60557	uvex rubiflex S XG35B	7 to 11	blue, black	251
60558	uvex profi ergo XG20A	6 to 11	white, orange, black	225
60560	uvex rubiflex S XG27B	7 to 11	blue, black	251
60573	uvex unilite 6605	6 to 11	black, black	221
60585	uvex unilite 7700	7 to 11	grey, black	221
60587	uvex unipur carbon FT	6 to 10	grey	223
60591	uvex unilite thermo plus cut C	7 to 11	lime, black	229
60592	uvex unilite thermo plus	7 to 11	black	229
60593	uvex unilite thermo	7 to 11	black	229
60595	uvex profatherm XB40	11	white	228
60600	uvex C500 XG	7 to 11	lime, anthracite	237
60604	uvex D500 foam	7 to 11	lime, anthracite	236
60838	uvex arc protect g1	7 to 11	anthracite	230
60840	uvex power protect V1000	7 to 11	red	230
60932	uvex unidur 6648	6 to 11	white, black	246
60938	uvex unidur 6659 foam	6 to 11	mottled grey, black	247
60943	uvex unipur 6630	6 to 11	white	222
60944	uvex unipur 6631	6 to 11	grey	222
60945	uvex compact NB27H	10	white, blue	227
60946	uvex compact NB27E	9 to 10	white, blue	227
60949	uvex profabutyl B-05R	7 to 11	black	255
60954	uvex rubiflex ESD NB35A	6 to 11	black	254
60957	uvex profaviton BV-06	8 to 11	black	255
60962	uvex u-strong N2000	S to XXL	blue	259
60968	uvex u-chem 3100	8 to 11	black	256
60971	uvex u-chem 3300	7 to 11	blue	256
60973	uvex unidur sleeve C	M, L	mottled grey	247
60974	uvex unidur sleeve C TL	M, L	mottled grey	247
89636	uvex rubiflex NB27	7 to 11	orange	227
89646	uvex rubiflex S NB27S	8 to 11	green	252
89647	uvex rubiflex S NB60S	9 to 11	green	252
89651	uvex rubiflex S NB60SZ	9 to 11	green	252
98891	uvex rubiflex S NB35S	8 to 11	green	252
98902	uvex rubiflex S NB40S	8 to 11	green	252



Safety Gloves

Overview

HexArmor®

Art. no.	Art. code	Sizes	Colour	Page
60005	PointGuard® Ultra 90931	6 to 12	black	265
60010	ThornArmor 3092	5 to 11	brown/black	269
60609	Chrome SLT 4070	6 to 12	orange/grey	270
60614	Helix® 2082	7 to 11	green mottled/black	266
60638	PointGuard® Ultra 9032	7 to 10	yellow/blue	264
60642	Helix® 1095	6 to 12	grey/black/yellow	271
60646	Thin Lizzie™ Thermal 2099	6 to 10	yellow/black/red	270
60648	Thin Lizzie™ 2090X	5 to 12	grey/yellow	273
60650	Thin Lizzie™ 2095	5 to 12	blue/black/yellow	273
60651	Rig Lizard 7101	6 to 12	yellow/blue	271
60652	Thin Lizzie™ Fluid 7102	6 to 12	blue/yellow	271
60655	Chrome SLT® 4062	6 to 12	beige	268
60659	Helix® 2065	6 to 12	blue/black	267
60660	Helix® 2076	5 to 13	blue mottled/black	266
60661	Helix® 2062	6 to 12	yellow/black	268
60662	Helix® 3000	6 to 12	yellow/black	272
60665	Helix® 3003	7 to 10	black/black	272
60666	Helix® 3007	6 to 12	red/yellow/black/grey	272
60668	Helix® 3033	6 to 11	mottled blue	268
60670	Rig Lizard® 2021X	6 to 12	yellow/black/red	274
60673	Chrome 4023M	7 to 12	grey/green	269
60681	Rig Lizard 2038	6 to 12	red/yellow	273
60682	Rig Lizard 2039	6 to 12	red/yellow	274
60683	Helix® 3023	6 to 11	mottled blue/black	266
60684	Helix® 3070	7 to 11	blue/black	267
60685	Helix® 3071	7 to 11	blue/black	267
60981	SharpsMaster II® 9014	6 to 10	white/orange	264
60982	Arm Guard AG8TW	7 to 10	black	264
60983	Hercules® NSR 3041	7 to 11	black	265
60984	9000 Series 9013	7 to 11	mottled grey/black	270
60985	Arm Guard AG10009S	6 to 12	black/neon-yellow	269
60986	Chrome 4026	6 to 12	black/neon-yellow	274



Safety Footwear

Product system planet series › Safety Footwear

uvex has developed the **protecting planet** icon, to help raise awareness of its commitment to achieving increased sustainability. Based on the brand claim, **protecting people**, our sustainable approach integrates three core interlinked pillars – **ecology, economy** and **social responsibility**, that are incorporated throughout the business to improve our sustainability performance.

This explains the comprehensive audit, measurement and evaluation management process uvex undertakes along the entire value chain to ensure its products are as sustainable as possible.

uvex 1 X-craft planet

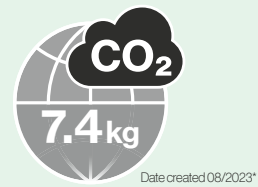

MADE IN ITALY

protecting planet
by using bio-based material //
by using recycled material //
by maximum reduction of pollutants

Upper

› 100 percent recycled polyester made from PET bottles

Textile penetration resistance

› 100 percent recycled fibres

Distance mesh lining

› 52 percent recycled polyester and 18 percent bamboo fibres

Comfortable climatic insole

› 73 percent recycled PU foam and 85 percent recycled polyester

Health

› produced in accordance with the provisions of the REACH regulation and beyond, according to the specifications of the uvex banned hazardous substances list

Upper
100%
 Recycled polyester

Midsole
15%
 Recycled
 PU surplus



68081

Lining
18%
 Bamboo



protecting planet

by using environmentally-friendly packaging

Shoe boxes

- › 90 percent recycled cardboard
- › 100 percent recycled tissue paper

Instructions for use

- › 100 percent recycled paper



protecting planet

by reducing waste //
 by reducing CO₂ emissions

Certifications

- › Environmental Management ISO 14001 (since 2017)

Production

- › exclusively with green electricity and green gas
- › Use of a photovoltaic system
- › Continuous optimisation of the cleaning and injection process

Waste prevention

- › Continuous process and tool optimisation to reduce PU waste
- › uvex i-PUREnrj planet midsole made of 15 percent granulated and recycled PU surplus that cannot be prevented



The uvex brand is our responsibility

We have been producing and selling high-quality products for the protection of people in sport, leisure and work for **over 90 years**. And if you want to protect people, **you have to take responsibility**.

It is precisely from this mission that our obligation derives to act in a **sustainable, social and socially-responsible** manner.

uvex safety footwear

The safety footwear product group has embodied its motto, protecting planet, for over 10 years. Our uvex Cagi production facility in Italy is a certified environmental management system in accordance with ISO 14001 and has been exclusively making use of green electricity and green gas since 2019. A photovoltaic system on the roof provides environmentally friendly solar energy.

Since 2011, we have implemented numerous projects to reduce the amount of PU waste generated. Since the end of 2022, we have been able to granulate PU surpluses and reuse them in our midsoles. We now use the uvex i-PUREnrj planet midsole with 15% granulate in over 30 models. The goal is to continuously increase the proportion of recycled and bio-based materials in the product portfolio.

Materials and procurement

- › By 2024: at least one recycled component in 100% of our catalogue range
- › Goal by 2030: 10% of the weight of the item is made from sustainable materials
- › Collaboration with the Leather Working Group for certified leather
- › Main suppliers are ISO 14001-certified environmental management systems

Production

- › Reuse of PU surplus generated by uvex production processes as granules in uvex i-PUREnrj planet midsoles and uvex x-tended grip planet outsoles
- › Continuous optimisation of the injection and cleaning processes
- › Continuous measures to reduce CO₂ and waste

Packaging

- › Shoe box made of 90% recycled paper
- › Tissue paper and instructions for use made from 100% recycled paper

Product lifecycle

- › The use of high-quality and durable materials in combination with professional workmanship ensures the longevity of our products.
- › uvex overperformance defines standards that exceed test requirements
- › Initial projects with external partners to recycle safety shoes

Green electricity

100%

at the uvex Cagi site

Number of models with
uvex i-PUREnrj planet
midsole

33

with 15%
granulate



PU waste reduction at
uvex Cagi

-46%

since 2011

Proportion of models with at least
one sustainable component

100%

in 2024 catalogue



Safety footwear for the highest demands

uvex safety footwear competence center



Innovation:

One of the most state-of-the-art production facilities in Europe

Laser roughing cell provides excellent-quality rough contours for optimal sole adhesion.

 **uvex competence center for safety footwear in Ceva (CN), Italy**

Development expertise, state-of-the-art robot-controlled production systems and optimised process structures to meet the highest ecological standards guarantee the first-class and sustainable quality of our safety shoes.

The production in Italy, which is one of the most modern production facilities for safety shoes in Europe, ensures efficient, resource-saving production and short distances from manufacturer to user.

 **Expertise**

- production of direct-injected safety shoes with outsoles made of polyurethane, thermoplastic polyurethane and rubber
- innovative production technologies, e.g. for using rebound properties
- six DESMA direct-injection machines for producing uvex outsoles, with DESMA AMIR system (automated material handling with integrated robots)
- extensively equipped test laboratory for quality and production assurance and for product development



Specialisation:

Direct injection of uvex safety shoe soles

Made in uvex
Made in Italy

Sustainability

- uses 100% green energy and green gas
- uses environmentally friendly solar energy (photovoltaic system installed since 2011)
- PUR waste management for recycling and saving polyurethane waste
- uses water-based release agents (numerous approvals in the automotive and supplier industries)

Certifications

- ISO 9001-certified quality management system (since 2003)
- ISO 14001-certified environmental management system (since 2017, first certificate in the uvex safety group)
- ISO 45001-certified occupational health and safety management system (since 2020, replacement for OHSAS 18001 certification)

Expertise at uvex headquarters in Fürth, Germany

- product design and development
- biomechanics
- model building and prototyping
- quality and international manufacturing support
- supply chain management
- commercial processing
- process engineering
- training, product management and marketing

Responsibility:

Uses renewable energy and CO₂-neutral electricity and gas



Safety Footwear

Areas of application: light · medium · heavy



light areas of application

'Light' covers all areas of application where work is primarily carried out indoors and without significant demands on the physical properties of the outsole. Examples include assembly workplaces, as well as storage and logistics areas. We recommend products from the uvex 1 G2, uvex 1, uvex 1 x-tended support, uvex 1 sport, uvex 1 sport white and uvex 1 business product groups.

medium areas of application

'Medium' applications usually take place both indoors and outdoors, with the outsole needing to be significantly more robust. Typical users include manual labourers, public sector employers and people working the chemical industry. We recommend products from the uvex 2, uvex 2 MACSOLE®, uvex 2 construction, uvex 2 xenova and uvex 2 trend product groups.

heavy areas of application

'Heavy' applications involve external influences that place extensive demands on the shoe, its durability and stability. They are usually found in heavy mechanical engineering and in the construction industry, especially in building and civil engineering. We recommend products from the uvex 3, uvex 3 MACSOLE® and uvex 3 asphaltpro product groups.

Safety Footwear

uvex multiple fit system

uvex multiple fit system

As part of the safety footwear multiple fit system, a footwear style is offered in the same size but in a range of different fits. The different fits are based on the measurement of the widest part of the foot. While the foot is under load, a measurement is taken of either the circumference of the foot at the base joint of the big toe and the base joint of the little toe, or alternatively the width of the foot at this point (see opposite).

The classification of sizes and the corresponding values are detailed in the table below (all measurements in mm):

uvex shoe size	Foot length	UK size	Width 10	Width 11 (standard)	Width 12	Width 14
35	210-217	3	216.5	222.5	228.5	240.5
36	218-225	3.5	221	227	233	245
37	226-232	4	225.5	231.5	237.5	249.5
38	233-240	5	230	236	242	254
39	241-247	6	234.5	240.5	246.5	258.5
40	248-255	6.5	239	245	251	263
41	256-262	7	243.5	249.5	255.5	267.5
42	263-270	8	248	254	260	272
43	271-277	9	252.5	258.5	264.5	276.5
44	278-285	10	257	263	269	281
45	286-292	10.5	261.5	267.5	273.5	285.5
46	293-300	11	266	272	278	290
47	301-307	12	270.5	276.5	282.5	294.5
48	308-315	13	275	281	287	299
49	316-322	14	279.5	285.5	291.5	303.5
50	323-330	14.5	284	290	296	308
51	331-337	15	288.5	294.5	300.5	312.5
52	338-345	16	293	299	305	317

All measurements in mm.

Anatomical circumference of the foot

Base joint of the big toe

Base joint of the little toe

The required width can be determined from the table according to the wearer's foot length.

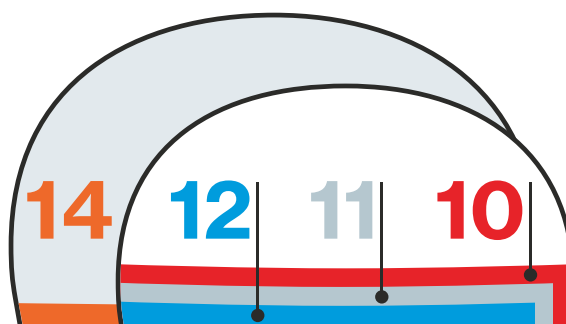

uvex fit advisor app

- User-friendly operation
- Automatic foot recognition
- Size and width recommendation
- Shoe recommendation based on the area of application
- Filter options in the footwear advisor



Find out how it works



Safety Footwear Technologies

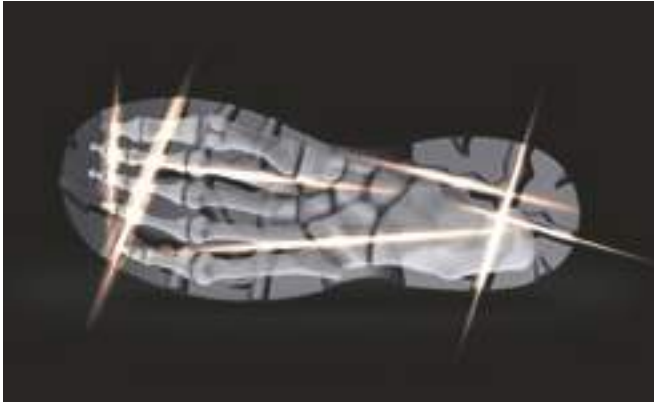

bionom X

Unique design approach of safety shoes based on biomechanics. The visible, shared properties optimise the interaction between the foot, the upper part of the shoe, the sole and the ground, ensuring exceptional performance and comfort for many applications.

clima zone

Innovative climate control system that optimises breathability and climate management. The selection of materials, reduced number of layers and intelligent processing technologies all help to draw moisture away from the foot and ensure exceptional wearer comfort.



Patented rubber compound especially for the uvex and Heckel brands. Featuring exceptional slip resistance, durability, abrasion resistance, grip, heat and cold resistance, chemical resistance and high elasticity, the rubber outsole is ideal for medium and heavy-duty applications.

MACSOLE® technology with added recycled rubber in the form of devulcanised powder and granulate forms the basis of MACSOLE® planet. Using recycled material in this way saves resources and reduces waste while maintaining the same level of performance.

i-PUREnrj

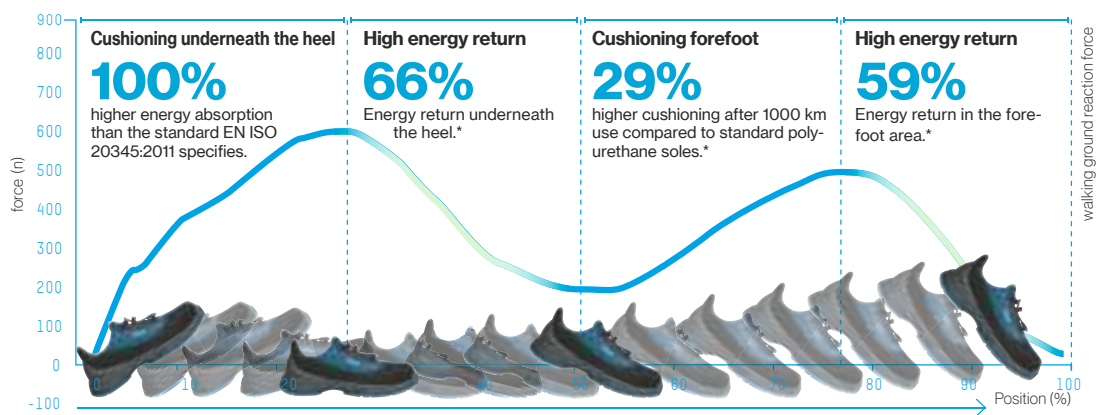

Midsole with shock absorption and energy-return features, made of foamed polyurethane. This helps the wearer keep fit for longer and reduces premature fatigue and the risk of injury.

Safety Footwear Technologies



Water vapour permeability

40x

better than the minimum requirement of EN ISO 20345

Water vapour coefficient

17x

better than the minimum requirement of EN ISO 20345

Water penetration

100%

better than the minimum requirement of EN ISO 20345

Water absorption

10x

better than the minimum requirement of EN ISO 20345

uvex i-PURE nrj planet

uvex i-PUREnrj technology plus up to 20% recycled polyurethane residues from our in-house production processes. Using recycled material in this way saves resources and reduces waste while maintaining the same level of performance.

uvex x-dry knit

The unique, breathable and water-resistant knitted upper prevents sweating due to overheating and prevents water entering the shoe from the outside.

Abrasion with uvex x-tended grip

66%

less abrasion than standard

With double load

33%

less abrasion than standard



uvex x-tended grip planet

The TPU outsole with up to 10% recycled PU granulate provides abrasion resistance and slip resistance on smooth and wet floors.

#Weave
SEE THE LIGHTER SIDE

Weave's patented structure in the grooves of the sole reduces the weight by up to 20%.



Safety Footwear

Pictogram overview

ankle pro

uvex anklepro

Absorbent foam in the ankle area provides excellent protection against impacts.

flex zone

uvex flexzone

Integrated flex groove in the midsole design increases sole flexibility when bending the forefoot and improves comfort during tasks that require kneeling.

lace lock

uvex lacelock

Locking lace hooks ensure increased stability in the midfoot area.

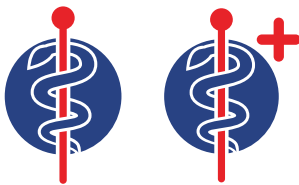

uvex medicare

Certified for orthopaedic adjustments in accordance with EN ISO 20345:2022, German DGUV regulation 112-191 and/or Austrian ÖNORM Z 1259.

uvex medicare = certified for orthopaedic insoles

uvex medicare + = certified for orthopaedic insoles and shoe adjustments



Silicone-free

Free of silicones, plasticisers and other paint wetting impairment substances in accordance with automotive industry tests.

water stop

uvex waterstop

Leather that protects against water penetration for four times longer than is required by the safety shoe standard.



Snowflake

Shoes with cold-insulating lining material that keeps the foot warm for longer.

work zone

uvex workzone

Forefoot protection provided by a dynamic scuffcap in addition to high-performance PUtek upper for demanding tasks.



**DIALED IN.
PRECISION FIT.**

The BOA® Fit System.

Delivering fit solutions purpose-built for performance, the BOA® Fit System is featured in products across industries (in medical, sports and workwear) and consists of three integral parts: a micro-adjustable dial, a super-strong lightweight lace and low friction lace guides.

The BOA® benefits.

Fit to perform.

Dial in your precise fit quickly and effortlessly. Even micro adjustments can be made quickly and easily on the fly, so you can always get the job done.

Confidence in all conditions.

The BOA® Fit System is extremely robust and has been tested under the toughest conditions. It will work as hard as you do so you can stay focused and confident in any environment - without ever having to remove your gloves.



Stay secure and focused.

BOA®'s precision engineered laces stay contained in the dial cartridge, out our your way and out of machinery.

Fit for life with BOA®.

The BOA® Fit System dials and laces are guaranteed for the lifetime of the product on which they are integrated.

How it works.

-  push in to engage
-  turn to tighten
-  pull up for quick release



sympatex®

Excellent comfort whatever the weather: waterproof, breathable, windproof

There is nothing more unpleasant than wet and cold clothing and shoes. Sympatex has therefore developed a special membrane which absorbs the water vapour and removes it to the outside. This keeps the foot warm and dry even in extreme situations.

And the best thing about it is that the higher the physical activity, the more efficient the sympatex membrane works. Shoes with a sympatex membrane also provide effective protection from low temperatures and rain.

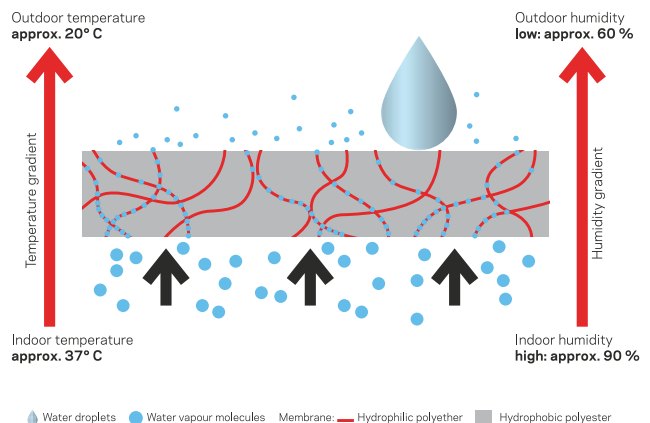

-  100% WATERPROOF
-  100% WINDPROOF
-  OPTIMALLY BREATHABLE
-  DURABLE
-  RECYCLABLE & RECYCLED
-  PFC-FREE
-  PTFE-FREE
-  CO2 NEUTRAL



www.sympatex.com

Personal insoles are not permitted in safety shoes.



Orthopaedic solutions for uvex safety shoes

Our feet are extremely important for our daily life – after all they help us to stand and move from A to B. It is therefore particularly important to protect our feet in working life – whether that's because we're running, kneeling, working on a machine or in order to prevent an occupational accident. Safety shoes are tested and certified at regular intervals by independent test institutes for protective features, such as ESD, cap testing etc. and for effectiveness, in accordance with the requirements of DIN EN ISO 20345.

In order to ensure that all safety-related protective features are still guaranteed in the event of an orthopaedic change to the safety shoe, orthopaedic insoles must only be used in combination with tested, orthopaedic materials.

This means that personal orthopaedic insoles are not allowed in safety shoes. All uvex medicare products have therefore been tested and certified in combination with uvex safety shoes.



uvex medicare

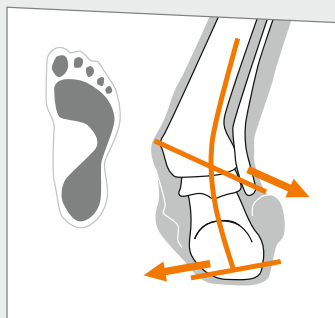

Skewfoot

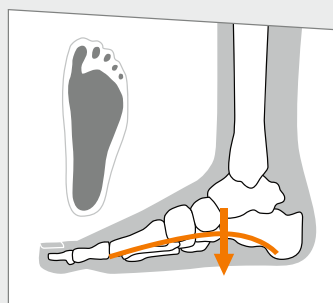

Flatfoot

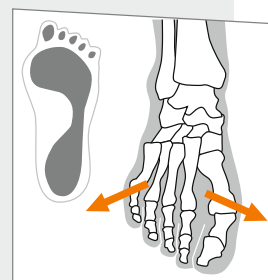

Splayfoot

MADE FOR YOUR FEET

MADE IN UVEX



How do I get an orthopaedic adjustment for uvex safety shoes?

uvex requires the footprint of your feet. This can be taken by our field service on site or you can use our uvex medicare footprint set – a convenient, simple and flexible way to self-record the footprint. All order details can be found on the order form in the folder.



Instructions



1 Separate the white sheet from the clear protective film and place the film over the blueprint, making sure that there are no wrinkles.



2 Place this on a flat surface and place your foot in the middle of it, putting your full body weight onto it. Draw around the foot with a pen.



3 Peel off the transparent film and remove the blueprint. Now place the film with your footprint on the chequered backing sheet and smooth it out, ensuring that there are no creases.

Repeat the process for your other foot.

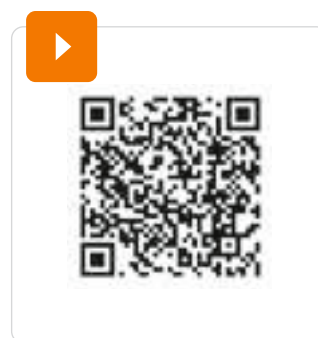

Watch our How-to video for a clear explanation of the individual steps.

Simply scan the QR code.



Safety Footwear

Standards · Labels

Labelling

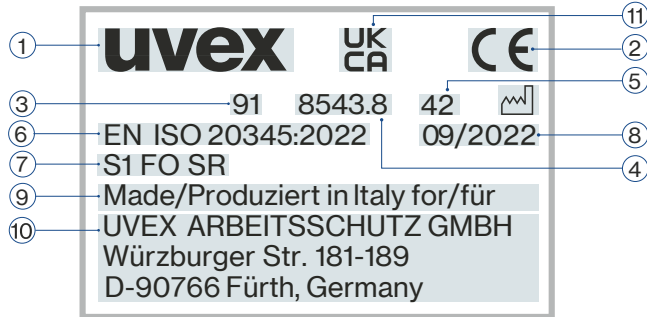

The labelling on the shoe contains the following information

- ① Manufacturer
- ② CE symbol
- ③ Manufacturer's type designation
- ④ Article number
- ⑤ Size
- ⑥ Number of European standard
- ⑦ Symbol for protection
- ⑧ Date of manufacture
- ⑨ Country of Manufacture
- ⑩ Postal address of the manufacturer
- ⑪ UKCA symbol

Basic and additional requirements for safety shoes (in accordance with EN ISO 20345:2022, marking S) and occupational shoes (in accordance with EN ISO 20347:2022, marking O)

Symbol	Requirement	Category												
		SB	S1	S2	S3	S3L	S3S	S5	S6	S7	S7L	S7S	O1	O2
-	Basic requirements	X	X	X	X	X	X	X	X	X	X	X	X	X
-	Toe cap, tested via 200 joule drop test and 15 kilonewton pressure test	X	X	X	X	X	X	X	X	X	X	X	-	-
-	Footwear made of leather or other materials, not including solid rubber or total polymers	O	X	X	X	X	X	-	X	X	X	X	X	X
-	Footwear made of solid rubber or total polymers	O	-	-	-	-	-	X	-	-	-	-	-	-
-	Slip resistance on ceramic tile floors with SLS	X	X	X	X	X	X	X	X	X	X	X	X	X
-	Closed seat region	O	X	X	X	X	X	X	X	X	X	X	X	X
A	Antistatic footwear	O	X	X	X	X	X	X	X	X	X	X	X	X
E	Energy absorption of seat region	O	X	X	X	X	X	X	X	X	X	X	X	X
WPA	Water penetration and absorption of upper material	O	-	X	X	X	X	-	X	X	X	X	-	X
WR	Whole shoe waterproof	O	O	O	O	O	O	-	X	X	X	X	O	O
P	Perforation resistance, metallic insert	O	O	O	X	-	-	X	O	X	-	-	O	O
PL	Perforation resistance, non-metallic insert, tested with a 4.5 mm test nail	O	O	O	-	X	-	-	O	-	X	-	O	O
PS	Perforation resistance, non-metallic insert, tested with a 3.0 mm test nail	O	O	O	-	-	X	-	O	-	-	X	O	O
-	Treaded sole	O	O	O	X	X	X	X	O	X	X	X	O	O

Additional requirements for special applications

Symbol	Requirement
FO	Fuel resistance and oil resistance
SR	Slip resistance on ceramic tile floors with glycerol
HI	Heat insulation of the sole complex
CI	Cold insulation of the sole complex
HRO	Heat resistance of the outsole
M	Metatarsal protection
AN	Ankle protection
CR	Cut resistance of the upper part of the shoe
SC	Abrasion resistance of optional overcaps
LG	Outsoles provide hold on ladders

X = Requirement must be fulfilled O = Requirement may be fulfilled, but is not mandatory - = Requirement cannot be fulfilled

To ensure optimal clarity, we have included the labelling in accordance with both the old and the new standard in this catalogue. The new labelling on the products will be introduced gradually. The label on your product will help you to identify the version of the standard to which the product is certified.

Safety Footwear

Standards · Labels · ESD

Perforation resistance

The perforation resistance of the footwear has been measured in a laboratory using standardised nails and forces. Nails with a smaller diameter and higher static or dynamic loads increase the risk of perforation. Under these conditions, additional protective measures should be considered. Three generic types of perforation-resistant insoles are currently available for PPE footwear. These include types made of metal materials and of non-metallic materials, which must be chosen by means of an activity-based risk assessment. All types offer protection against perforation risks, but each has different additional advantages or disadvantages, including the following:

Metal (P e.g. S1 P, S3):

Is less affected by the shape of the sharp object/hazard (i.e. diameter, geometry, sharpness) due to the processes used in shoe manufacturing, however, it may not be possible to cover the entire bottom of the foot.

Non-metal (PS or PL or category e.g. S1 PS, S3L):

May be lighter and more flexible and may cover a larger area, but perforation resistance may vary more depending on the shape of the sharp object/hazard (i.e. diameter, geometry, sharpness). In terms of the protection obtained, two types are available. Type PS may offer better protection against objects with a smaller diameter than type PL.

Electrostatic

Controlling unwelcome electrostatic charge is becoming an increasingly important role in industry, as more and more employees come into contact with processes, materials or objects which are sensitive to electrostatic charge. It is often necessary to use safety footwear as part of a system to conduct electrostatic charge in such workplaces.

Independent of various measuring methods, volume resistance between 100 kilohms (1.0×10^5 ohms) and 100 megohms (1×10^8 ohms) is required to fulfil the various relevant standards (e.g. EN ISO 20345, EN 61340).

All ESD-certified products in this catalogue feature the ESD symbol.



These products are also suitable in accordance with the specification for conductive footwear in the German Technical Rules for Hazardous Substances (TRGS) 727 "Avoiding risks of ignition resulting from electrostatic charges."

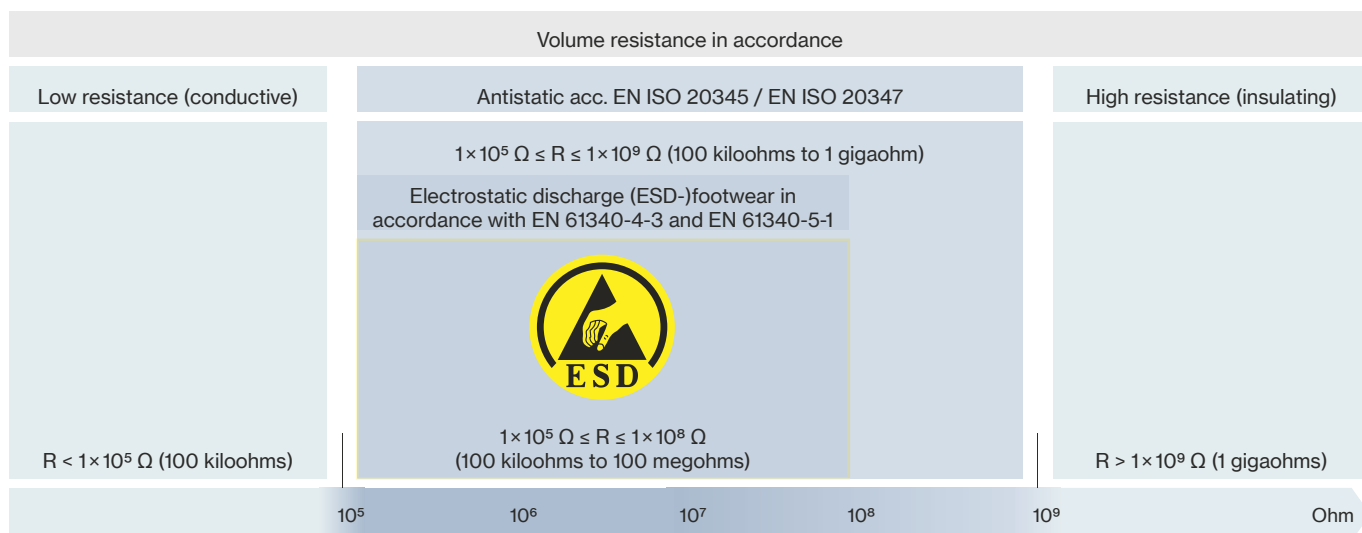

R = electrical resistance





Safety Footwear

light areas of application

uvex

Safety Footwear

uvex 1 x-craft planet



68081
68082
68083



Date created: 08/2023*

clima zone i-PUREnrj x-tendedgrip



uvex 1 x-craft planet · Shoe S1 PL

The sustainable cherry on the cake. The uvex 1 x-craft planet offers the next level of sustainability. It is the perfect combination of the innovations of the uvex 1 x-craft product family and the sustainable materials for which the uvex 1 G2 planet is known: Midssole and outsole with up to 15% recycled granulate from residues, upper made of recycled and bio-based materials such as PET bottles and bamboo. In total, it consists of 30% recycled materials in accordance with DIN EN ISO 14021:2016.

Features:

- uvex i-PUREnrj planet midsole with shock-absorption and energy-return features, made with 15% recycled granulate from residues generated by uvex production processes
- abrasion-resistant uvex x-tended grip planet TPU outsole made with 10% recycled granulate from residues generated by uvex production processes
- foamed polyurethane scuffcap
- foamed polyurethane heel basket
- 100% metal-free protective toe cap

- flexible textile penetration resistance
- lightweight and breathable uvex x-dry knit planet textile upper
- breathable distance mesh lining made from 18% bamboo and 52% recycled polyamide
- elastic laces
- ESD certified
- sizes 35 to 40 produced using a womens' last
- metal-free
- suitable for people allergic to chrome
- removable antistatic comfortable insole (Art. no.: 95797-0)

Sustainability:

- outsole, midsole, insole, penetration resistance, upper, laces and lining made wholly or partly from recycled materials
- free from harmful substances in accordance with the uvex restricted substances list



uvex 1 x-craft planet	Shoe
Art. no. Width 10	68081
Art. no. Width 11	68082
Art. no. Width 12	68083
Art. no. Width 14	-
Standard EN ISO 20345:2011	-
Standard EN ISO 20345:2022	S1 PL FO SC SR
Upper	textile
Lining	distance mesh lining
Fastening	elastic laces
Sizes	35 to 52
Order unit	PR

You can find more information on uvex medicare on pages 430 to 437

uvex

uvex 1 x-craft pro

the next level



Reliable comfort thanks to a flex-zone within the i-PUREnrj planet midsole and bionom x sole design



workzone with direct injected scuffcap and PUtek upper for extreme durability



Breathability thanks to perforated tongue and lightweight ripstop upper



Sporty look with pull tab and high-quality 3D details on the upper



You can find more information at www.uvex-safety.com/en/x-craft/

Safety Footwear

uvex 1 x-craft pro



68001
68002
68003
68004

68011
68012
68013
68014

clima zone i-PUREnrj x-tendedgrip



uvex 1 x-craft pro · Shoe S1 PL · Lace-up boot S1 PL

Designed for makers. Full support and flexibility are guaranteed by the sole with uvex bionom x and integrated flexzone in the forefoot area. Thanks to the dynamic scuffcap, technological upper materials and perforated tongue design, the range offers added abrasion resistance, protection and breathability. Whether sustainability, comfort, sportiness or innovation, the uvex 1 x-craft is simply the next level safety shoe.

Features:

- uvex i-PUREnrj planet midsole with shock-absorption and energy-return features, made with 15% recycled granulate from residues generated by uvex production processes
- abrasion-resistant uvex x-tended grip planet TPU outsole made with 10% recycled granulate from residues generated by uvex production processes
- foamed polyurethane scuffcap
- foamed polyurethane heel basket

- 100% metal-free protective toe cap
- flexible textile penetration resistance
- breathable, lightweight and tear-resistant ripstop upper
- durable, robust and flexible PUtek upper in the forefoot area
- breathable distance mesh lining
- ESD certified
- sizes 35 to 40 produced using a womens' last
- metal-free
- suitable for people allergic to chrome
- removable antistatic comfortable insole (Art. no.: 95797-0)

Sustainability:

- midsole, outsole, penetration resistance and removable insole made wholly or partly from recycled materials
- free from harmful substances in accordance with the uvex restricted substances list



uvex 1 x-craft pro	Shoe	Lace-up boot
Art. no. Width 10	68001	68011
Art. no. Width 11	68002	68012
Art. no. Width 12	68003	68013
Art. no. Width 14	68004	68014
Standard EN ISO 20345:2011	-	-
Standard EN ISO 20345:2022	S1 PL FO SC SR	S1 PL FO SC SR
Upper	textile/ripstop	textile/ripstop
Lining	distance mesh lining	distance mesh lining
Fastening	elastic laces	shoe laces
Sizes	35 to 52	35 to 52
Order unit	PR	PR

uvex

Safety Footwear

uvex 1 x-craft



68021
68022
68023
68024



68031
68032
68033
68034



68041
68042
68043
68044



clima zone i-PUREnrj



uvex 1 x-craft · Perforated shoe S1 PL · Shoe S3L · Lace-up boot S3L

Features:

- uvex i-PUREnrj planet midsole with shock-absorption and energy-return features, made with 15% recycled granulate from residues generated by uvex production processes
- PU outsole
- foamed polyurethane scuffcap
- foamed polyurethane heel basket
- 100% metal-free protective toe cap
- flexible textile penetration resistance
- lightweight and breathable microvelour upper
- breathable distance mesh lining

- ESD certified
- sizes 35 to 40 produced using a womens' last
- metal-free
- suitable for people allergic to chrome
- removable antistatic comfortable insole (Art. no.: 95797-0)

Sustainability:

- midsole, penetration resistance and removable insole made wholly or partly from recycled materials
- free from harmful substances in accordance with the uvex restricted substances list

uvex 1 x-craft	Perforated Shoe	Shoe	Lace-up boot
Art. no. Width 10	68021	68031	68041
Art. no. Width 11	68022	68032	68042
Art. no. Width 12	68023	68033	68043
Art. no. Width 14	68024	68034	68044
Standard EN ISO 20345:2011	-	-	-
Standard EN ISO 20345:2022	S1 PL FO SC SR	S3L FO SC SR	S3L FO SC SR
Upper	microvelour	microvelour	microvelour
Lining	distance mesh lining	distance mesh lining	distance mesh lining
Fastening	elastic laces	elastic laces	shoe laces
Sizes	35 to 52	35 to 52	35 to 52
Order unit	PR	PR	PR

You can find more information on uvex medicare on pages 430 to 437

Safety Footwear
uvex 1 x-craft



68137
68138
68139
68130



68147
68148
68149
68140



68157
68158
68159
68150

clima zone i-PUREnrj



uvex 1 x-craft · Perforated shoe S1 · Shoe S2 · Lace-up boot S2

Features:

- uvex i-PUREnrj planet midsole with shock-absorption and energy-return features, made with 15% recycled granulate from residues generated by uvex production processes
- PU outsole
- foamed polyurethane scuffcap
- foamed polyurethane heel basket
- 100% metal-free protective toe cap
- lightweight and breathable microvelour upper
- breathable distance mesh lining
- ESD certified

- sizes 35 to 40 produced using a womens' last
- metal-free
- suitable for people allergic to chrome
- removable antistatic comfortable insole (Art. no.: 95797-0)

Sustainability:

- midsole, insole and removable insole made wholly or partly from recycled materials
- free from harmful substances in accordance with the uvex restricted substances list



uvex 1 x-craft	Perforated Shoe	Shoe	Lace-up boot
Art. no. Width 10	68137	68147	68157
Art. no. Width 11	68138	68148	68158
Art. no. Width 12	68139	68149	68159
Art. no. Width 14	68130	68140	68150
Standard EN ISO 20347:2011	-	-	-
Standard EN ISO 20347:2022	S1 FO SC SR	S2 FO SC SR	S2 FO SC SR
Upper	microvelour	microvelour	microvelour
Lining	distance mesh lining	distance mesh lining	distance mesh lining
Fastening	elastic laces	elastic laces	shoe laces
Sizes	35 to 52	35 to 52	35 to 52
Order unit	PR	PR	PR

uvex 1 G2 planet

100% Performance.
30% recycled.*

100% recycled shoelaces

Penetration resistance made from **100%** recycled fibres

40% recycled material in the TPU scuffcap

uvex x-tended grip planet
10%
of TPU outsole is made of recycled PU waste

Comfortable climatic insole
100%
recycled polyester and PU foam

uvex x-dry knit planet
100%
recycled PET bottles in the upper

Distance mesh lining
18%
of the lining is made of bamboo, 52% made of recycled polyester

uvex i-PUREnrj planet
20%
of the midsole made of granulate from recycled PU residues

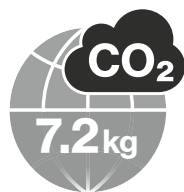

Date created 01/2023



You can find more information at www.uvex-safety.com/uvex-1-g2-planet/



Safety Footwear

uvex 1 G2



68242



clima zone i-PUREnrj x-dryknit x-tendedgrip



uvex 1 G2 planet · Shoe S1 PL

Recycled down to the last crumb: From the upper to the sole, the new uvex 1 G2 planet offers both sustainability and performance in one. The injected polyurethane midsole contains up to 20% granulate made using PU waste from our production processes. In accordance with DIN EN ISO 14021:2016, it consists of 30% recycled materials in terms of weight, without compromising its protective properties or comfort compared to the well-known uvex 1 G2 models. Many of the shoes components, such as the outer shoe material and insole, are made from 100% recycled materials.

Features:

- uvex i-PUREnrj planet midsole with shock-absorption and energy-return features, made with 20% recycled granulate from residues generated by uvex production processes
- abrasion-resistant uvex x-tended grip planet TPU outsole made with 10% recycled granulate from residues generated by uvex production processes
- foamed polyurethane heel basket

- 100% metal-free protective toe cap
- flexible textile penetration resistance
- lightweight and breathable uvex x-dry knit planet textile upper
- TPU scuffcap made from 40% recycled material
- breathable distance mesh lining made from 18% bamboo and 52% recycled polyamide
- ESD certified
- dust tongue
- sizes 35 to 40 produced using a womens' last
- suitable for people allergic to chrome
- removable antistatic comfortable insole (Art. no.: 94907-0)

Sustainability:

- outsole, midsole, insole, penetration resistance, upper, laces, scuffcap and lining made wholly or partly from recycled materials
- free from harmful substances in accordance with the uvex restricted substances list

uvex 1 G2 planet	Shoe
Art. no. Width 11	68242
Standard EN ISO 20345:2011	S1 P SRC
Standard EN ISO 20345:2022	S1 PL FO SR
Upper	textile
Lining	distance mesh lining
Fastening	elastic laces
Sizes	35 to 52
Order unit	PR

uvex 1 G2

Science. Not Fiction.

uvex i-PUREnrj Technology

Cushioning. Stability. Energy Return.

The future is full of energy with the pioneering uvex 1 G2. uvex's innovative new polyurethane sole technology – uvex PUREnrj – returns the landing energy over the entire sole unit back to the wearer. It redefines shock absorption and stability, with noticeably greater comfort and significantly lower fatigue in the feet for a working day that is brimming with energy – from beginning to end.

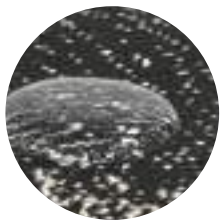

Water-repellent and breathable knitted upper material.

**Less fatigue.
More comfort.
More performance**

21%

less perceived fatigue compared to standard polyurethane soles

68341
68342
68343
68344

uvex 1 G2	Shoe
Art. no. Width 10	68341
Art. no. Width 11	68342
Art. no. Width 12	68343
Art. no. Width 14	68344
Standard EN ISO 20345:2011	S1 P SRC
Standard EN ISO 20345:2022	S1 PL FO SR
Upper	textile
Lining	distance mesh lining
Fastening	elastic laces
Sizes	35 to 52
Order unit	PR

Abrasion and Slip resistance optimised



TPU-polyurethane outsole

Safety Footwear

uvex 1 G2



68361
68362
68363
68364



68371
68372
68373
68374



68381
68382
68383
68384



68401
68402
68403



68391
68392
68393
68394

clima zone i-PUREnrj x-tendedgrip



uvex 1 G2 · Sandal S1 PL · Perforated shoe S1 PL · Shoe S3L · Lace-up boot S3L

Features:

- uvex i-PUREnrj planet midsole with shock-absorption and energy-return features, made with 15% recycled granulate from residues generated by uvex production processes
- abrasion-resistant uvex x-tended grip planet TPU outsole made with 10% recycled granulate from residues generated by uvex production processes
- foamed polyurethane heel basket
- 100% metal-free protective toe cap
- flexible textile penetration resistance
- lightweight and breathable microvelour upper
- TPU scuffcap
- breathable distance mesh lining

- ESD certified
- dust tongue
- sizes 35 to 40 produced using a womens' last
- metal-free (Art. no.: 6836, 6839 only)
- suitable for people allergic to chrome
- removable antistatic comfortable insole (Art. no.: 94907-0)

Sustainability:

- midsole, outsole and insole made wholly or partly from recycled materials
- free from harmful substances in accordance with the uvex restricted substances list

uvex 1 G2	Sandal	Perforated shoe	Shoe	Shoe	Lace-up boot
Art. no. Width 10	68361	68371	68381	68401	68391
Art. no. Width 11	68362	68372	68382	68402	68392
Art. no. Width 12	68363	68373	68383	68403	68393
Art. no. Width 14	68364	68374	68384	-	68394
Standard EN ISO 20345:2011	S1 P SRC	S1 P SRC	S3 SRC	S3 SRC	S3 SRC
Standard EN ISO 20345:2022	S1 PL FO SC SR	S1 PL FO SC SR	S3L FO SC SR	S3L FO SC SR	S3L FO SC SR
Upper	microvelour	microvelour	microvelour	microvelour	microvelour
Lining	distance mesh lining	distance mesh lining	distance mesh lining	distance mesh lining	distance mesh lining
Fastening	hook-and-loop fastening	elastic laces	elastic laces	BOA® Fit System	shoe laces
Sizes	35 to 52	35 to 52	35 to 52	35 to 52	35 to 52
Order unit	PR	PR	PR	PR	PR

You can find more information on uvex medicare on pages 430 to 437

Safety Footwear

uvex 1 G2



68427
68428
68429
68420



68437
68438
68439
68430



68447
68448
68449
68440



68457
68458
68459
68450

clima zone i-PUREnrj x-tendedgrip



uvex 1 G2 · Sandal S1 · Perforated shoe S1 · Shoe S2 · Lace-up boot S2

Features:

- uvex i-PUREnrj planet midsole with shock-absorption and energy-return features, made with 15% recycled granulate from residues generated by uvex production processes
- abrasion-resistant uvex x-tended grip planet TPU outsole made with 10% recycled granulate from residues generated by uvex production processes
- foamed polyurethane heel basket
- 100% metal-free protective toe cap
- lightweight and breathable microvelour upper
- TPU scuffcap
- breathable distance mesh lining

- ESD certified
- dust tongue
- sizes 35 to 40 produced using a womens' last
- metal-free (Art. no.: 6842, 6845 only)
- suitable for people allergic to chrome
- removable antistatic comfortable insole (Art. no.: 94907-0)

Sustainability:

- midsole, outsole, insole and removable insole made wholly or partly from recycled materials
- free from harmful substances in accordance with the uvex restricted substances list

uvex 1 G2	Sandal	Perforated shoe	Shoe	Lace-up boot
Art. no. Width 10	68427	68437	68447	68457
Art. no. Width 11	68428	68438	68448	68458
Art. no. Width 12	68429	68439	68449	68459
Art. no. Width 14	68420	68430	68440	68450
Standard EN ISO 20345:2011	S1 SRC	S1 SRC	S2 SRC	S2 SRC
Standard EN ISO 20345:2022	S1 FO SR	S1 FO SR	S2 FO SR	S2 FO SR
Upper	microvelour	microvelour	microvelour	microvelour
Lining	distance mesh lining	distance mesh lining	distance mesh lining	distance mesh lining
Fastening	hook-and-loop fastening	elastic laces	elastic laces	shoe laces
Sizes	35 to 52	35 to 52	35 to 52	35 to 52
Order unit	PR	PR	PR	PR

Safety Footwear

uvex 1 G2



68487
68488
68489
68480

68467
68468
68469
68460

68527
68528
68529

68537
68538
68539

clima zone i-PUREnrj x-dryknit



uvex 1 G2 · Sandal S1 · Perforated shoe S1 · Shoe S1 · Lace-up boot S1

Features:

- uvex i-PUREnrj planet midsole with shock-absorption and energy-return features, made with 15% recycled granulate from residues generated by uvex production processes
- PU outsole
- foamed polyurethane heel basket
- 100% metal-free protective toe cap
- lightweight and breathable microvelour upper (6846, 6848)
- lightweight and breathable uvex x-dry knit textile upper (6852, 6853)
- TPU scuffcap (6852, 6853)
- breathable distance mesh lining
- ESD certified

- dust tongue
- sizes 35 to 40 produced using a womens' last
- metal-free (Art. no.: 6848, 6853 only)
- suitable for people allergic to chrome
- removable antistatic comfortable insole (Art. no.: 94907-0)

Sustainability:

- midsole, insole and removable insole made wholly or partly from recycled materials
- free from harmful substances in accordance with the uvex restricted substances list



uvex 1 G2	Sandal	Perforated shoe	Shoe	Lace-up boot
Art. no. Width 10	68487	68467	68527	68537
Art. no. Width 11	68488	68468	68528	68538
Art. no. Width 12	68489	68469	68529	68539
Art. no. Width 14	68480	68460	-	-
Standard EN ISO 20345:2011	S1 SRC	S1 SRC	S1 SRC	S1 SRC
Standard EN ISO 20345:2022	S1 FO SR	S1 FO SR	S1 FO SR	S1 FO SR
Upper	microvelour	microvelour	textile	textile
Lining	distance mesh lining	distance mesh lining	distance mesh lining	distance mesh lining
Fastening	hook-and-loop fastening	elastic laces	elastic laces	shoe laces
Sizes	35 to 52	35 to 52	35 to 52	35 to 52
Order unit	PR	PR	PR	PR

Safety Footwear

uvex 1 G2



68287
68288
68289
68280



68297
68298
68299
68290



68267
68268



68317
68318
68319
68310



68329

clima zone i-PUREnrj   

uvex 1 G2 · Sandal S1 · Perforated shoe S1 · Perforated lace-up boot S1 · Perforated boot S1

Features:

- uvex i-PUREnrj planet midsole with shock-absorption and energy-return features, made with 15% recycled granulate from residues generated by uvex production processes
- PU outsole
- foamed polyurethane heel basket
- 100% metal-free protective toe cap
- lightweight and breathable microvelour upper
- breathable distance mesh lining
- ESD certified
- dust tongue

- sizes 35 to 40 produced using a womens' last
- metal-free (Art. no.: 6828, 6831, 6832 only)
- suitable for people allergic to chrome
- removable antistatic comfortable insole (Art. no.: 94907-0)

Sustainability:

- midsole, insole and removable insole made wholly or partly from recycled materials
- free from harmful substances in accordance with the uvex restricted substances list

uvex 1 G2	Sandal	Perforated shoe	Perforated shoe	Perforated lace-up boot	Perforated boot
Art. no. Width 10	68287	68297	68267	68317	-
Art. no. Width 11	68288	68298	68268	68318	-
Art. no. Width 12	68289	68299	-	68319	68329
Art. no. Width 14	68280	68290	-	68310	-
Standard EN ISO 20345:2011	S1 SRC	S1 SRC	S1 SRC	S1 SRC	S1 SRC
Standard EN ISO 20345:2022	S1 FO SR	S1 FO SR	S1 FO SR	S1 FO SR	S1 FO SR
Upper	microvelour	microvelour	microvelour	microvelour	microvelour
Lining	distance mesh lining	distance mesh lining	distance mesh lining	distance mesh lining	distance mesh lining
Fastening	hook-and-loop fastening	elastic laces	elastic laces	shoe laces	hook-and-loop fastening
Sizes	35 to 52	35 to 52	35 to 43	35 to 52	35 to 52
Order unit	PR	PR	PR	PR	PR

You can find more information on uvex medicare on pages 430 to 437

Safety Footwear

uvex 1 G2



68497
68498
68499
68490



68507
68508
68509
68500



68307
68308
68309
68300



68337
68338
68339
68330

clima zone i-PUREnrj



uvex 1 G2 · Shoe S2 · Lace-up boot S2

Features:

- uvex i-PUREnrj planet midsole with shock-absorption and energy-return features, made with 15% recycled granulate from residues generated by uvex production processes
- PU outsole
- foamed polyurethane heel basket
- 100% metal-free protective toe cap
- lightweight and breathable microvelour upper
- breathable distance mesh lining
- ESD certified
- dust tongue

- sizes 35 to 40 produced using a womens' last
- metal-free (Art. no.: 6833, 6850 only)
- suitable for people allergic to chrome
- removable antistatic comfortable insole (Art. no.: 94907-0)

Sustainability:

- midsole, insole and removable insole made wholly or partly from recycled materials
- free from harmful substances in accordance with the uvex restricted substances list



uvex 1 G2	Shoe	Lace-up boot	Shoe	Lace-up boot
Art. no. Width 10	68307	68337	68497	68507
Art. no. Width 11	68308	68338	68498	68508
Art. no. Width 12	68309	68339	68499	68509
Art. no. Width 14	68300	68330	68490	68500
Standard EN ISO 20345:2011	S2 SRC	S2 SRC	S2 SRC	S2 SRC
Standard EN ISO 20345:2022	S2 FO SR	S2 FO SR	S2 FO SR	S2 FO SR
Upper	microvelour	microvelour	microvelour	microvelour
Lining	distance mesh lining	distance mesh lining	distance mesh lining	distance mesh lining
Fastening	elastic laces	shoe laces	elastic laces	shoe laces
Sizes	35 to 52	35 to 52	35 to 52	35 to 52
Order unit	PR	PR	PR	PR

uvex

uvex 1 sport – Winners at work



Designed for Individuals

Website



Sporty.
Premium wearer comfort and a sporty look.



Breathable.
Climate-optimised upper materials.



Lightweight. Ergonomic.
Slip-resistant dual-density polyurethane sole

Safety Footwear

uvex 1 sport



S1P | 65941 | **S1** | 65947
 65942 | 65948
 65943 | 65949
 65944 | 65940



65987
 65988
 65989
 65980



65961
 65962
 65963
 65964



uvex 1 sport · Shoe S1 · Shoe S1 P/S1 PL · Shoe S3L

Sporty design meets sophisticated functionality: The uvex 1 sport is a youthful and stylish shoe that also offers first-class wearer comfort. Thanks to its low weight, climate-optimised high-tech materials and ergonomic outsole, the uvex 1 sport is the ideal footwear for the working day and beyond.

Features:

- shock-absorbing PU midsole
- PU outsole
- 100% metal-free protective toe cap
- flexible textile penetration resistance (65941-4, 65961-4)
- lightweight and breathable microvelour upper (6596)
- lightweight and breathable textile upper (6598, 6594)

- TPU scuffcap
- breathable distance mesh lining
- ESD certified
- sizes 35 to 40 produced using a womens' last
- metal-free
- suitable for people allergic to chrome
- removable antistatic comfortable insole (Art. no.: 95797-0)

Sustainability:

- insole and heel cap made wholly or partly from recycled materials
- free from harmful substances in accordance with the uvex restricted substances list



uvex 1 sport	Shoe	Shoe	Shoe	Shoe
Art. no. Width 10	65941	65947	65987	65961
Art. no. Width 11	65942	65948	65988	65962
Art. no. Width 12	65943	65949	65989	65963
Art. no. Width 14	65944	65940	65980	65964
Standard EN ISO 20345:2011	S1 P SRC	S1 SRC	S1 SRC	S3 SRC
Standard EN ISO 20345:2022	S1 PL FO SC SR	S1 FO SC SR	S1 FO SC SR	S3L FO SC SR
Upper	textile	textile	textile	microvelour
Lining	distance mesh lining	distance mesh lining	distance mesh lining	distance mesh lining
Fastening	shoe laces	shoe laces	shoe laces	shoe laces
Sizes	35 to 52	35 to 52	35 to 52	35 to 52
Order unit	PR	PR	PR	PR

Safety Footwear

uvex 1 sport



65901
65902
65903
65904



65921
65922
65923
65924



uvex 1 sport · Shoe S1 PL/S3L

Features:

- shock-absorbing PU midsole
- PU outsole
- 100% metal-free protective toe cap
- flexible textile penetration resistance
- lightweight and breathable microvelour upper (6592)
- lightweight and breathable textile upper (6590)
- TPU scuffcap
- breathable distance mesh lining
- ESD certified

- sizes 35 to 40 produced using a womens' last
- metal-free
- suitable for people allergic to chrome
- removable antistatic comfortable insole (Art. no.: 95797-0)

Sustainability:

- insole and heel cap made wholly or partly from recycled materials
- free from harmful substances in accordance with the uvex restricted substances list

uvex 1 sport	Shoe	Shoe
Art. no. Width 10	65901	65921
Art. no. Width 11	65902	65922
Art. no. Width 12	65903	65923
Art. no. Width 14	65904	65924
Standard EN ISO 20345:2011	S1 P SRC	S3 SRC
Standard EN ISO 20345:2022	S1 PL FO SC SR	S3L FO SC SR
Upper	textile	microvelour
Lining	distance mesh lining	distance mesh lining
Fastening	shoe laces	shoe laces
Sizes	35 to 52	35 to 52
Order unit	PR	PR

Safety Footwear
uvex 1 sport white



65837
65838
65839

65807
65808
65809

65817
65818
65819

65821
65822
65823



uvex 1 sport white · Shoe S1/S2/S3L

The uvex 1 sport white safety shoe line combines a sporty design, optimal comfort and sophisticated functionality for working in areas where hygiene is important or foodstuffs are handled. The almost seamless upper finish prevents unwanted contaminants from getting inside the shoe when working in sensitive hygienic areas. The work shoes and removable comfortable climatic insoles can be washed at 30°C. uvex 1 sport white – pure sporty comfort for areas where hygiene is important, clean room applications, the food industry, the pharmaceutical industry, industrial kitchens and hospitality.

Features:

- shock-absorbing PU midsole
- PU outsole
- 100% metal-free protective toe cap

- flexible textile penetration resistance (6582)
- hydrophobic microfibre upper
- breathable distance mesh lining
- ESD certified
- dust tongue (6582)
- sizes 35 to 40 produced using a womens' last
- metal-free
- suitable for people allergic to chrome
- removable antistatic comfortable insole (Art. no.: 95797-0)

Sustainability:

- insole and heel cap made wholly or partly from recycled materials
- free from harmful substances in accordance with the uvex restricted substances list

uvex 1 sport white	Shoe	Shoe	Shoe	Shoe
Art. no. Width 10	65837	65807	65817	65821
Art. no. Width 11	65838	65808	65818	65822
Art. no. Width 12	65839	65809	65819	65823
Art. no. Width 14	-	-	-	-
Standard EN ISO 20345:2011	S1 SRC	S2 SRC	S2 SRC	S3 SRC
Standard EN ISO 20345:2022	S1 FO SR	S2 FO SR	S2 FO SR	S3L FO SR
Upper	microfibre	microfibre	microfibre	microfibre
Lining	distance mesh lining	distance mesh lining	distance mesh lining	distance mesh lining
Fastening	plastic closure/hook-and-loop	hook-and-loop fastening	-	shoe laces
Sizes	35 to 52	35 to 52	35 to 52	35 to 52
Order unit	PR	PR	PR	PR

uvex

uvex 1 sport white NC

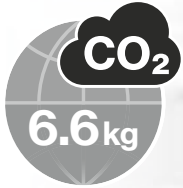

Date created 01/2023

nrj. style. everyday.



Sporty look



Breathable and liquid-resistant upper



Ergonomic PU outsole with uvex i-PUREnrj midsole



Elastic laces



You can find more information at : www.uvex-safety.com/uvex1sportwhitenc



Occupational shoes

uvex 1 sport white NC



65707
65708
65709



65717
65718
65719



65727
65728
65729

clima zone i-PUREnrj



uvex 1 sport white NC · Shoe O1/O2

Thanks to its lightweight design, high-tech materials and ergonomically designed outsole, the uvex 1 sport white NC is the ideal companion for the working day and beyond. The hydrophobic upper ensures optimised climate control and reliably protects the wearer against liquids and other contaminants.

Features:

- uvex i-PUREnrj midsole with shock-absorption and energy-return features
- PU outsole
- hydrophobic microfibre upper (6571, 6572)
- lightweight and breathable textile upper (6570)
- TPU scuffcap (6570)
- breathable distance mesh lining

- ESD certified
- dust tongue (6572)
- sizes 35 to 40 produced using a womens' last
- metal-free (Art. no.: 6571 only)
- suitable for people allergic to chrome
- removable antistatic comfortable insole (Art. no.: 95177-9)

Sustainability:

- insole, removable insole and heel cap made wholly or partly from recycled materials
- free from harmful substances in accordance with the uvex restricted substances list

uvex 1 sport white NC	Shoe	Shoe	Shoe
Art. no. Width 10	65707	65717	65727
Art. no. Width 11	65708	65718	65728
Art. no. Width 12	65709	65719	65729
Standard EN ISO 20347:2012	O1 FO SRC	O2 FO SRC	O2 FO SRC
Standard EN ISO 20347:2022	O1 FO SC SR	O2 FO SR	O2 FO SR
Upper	textile	microfibre	microfibre
Lining	distance mesh lining	distance mesh lining	distance mesh lining
Fastening	elastic laces	-	elastic laces
Sizes	35 to 52	35 to 52	35 to 52
Order unit	PR	PR	PR

Occupational shoes

uvex 1 sport NC



65937
65938
65939



uvex 1 sport NC - Shoe O1

Features:

- shock-absorbing PU midsole
- PU outsole
- lightweight and breathable textile upper
- TPU scuffcap
- breathable distance mesh lining
- ESD certified
- sizes 35 to 40 produced using a womens' last
- metal-free

- suitable for people allergic to chrome
- removable antistatic comfortable insole (Art. no.: 95177-9)

Sustainability:

- insole, removable insole and heel cap made wholly or partly from recycled materials
- free from harmful substances in accordance with the uvex restricted substances list

uvex 1 sport NC	Shoe
Art. no. Width 10	65937
Art. no. Width 11	65938
Art. no. Width 12	65939
Standard EN ISO 20347:2012	O1 FO SRC
Standard EN ISO 20347:2022	O1 FO SC SR
Upper	textile
Lining	distance mesh lining
Fastening	shoe laces
Sizes	35 to 52
Order unit	PR

uvex 1 business – the best of both worlds



Highstreet Fashion meets Safety



You can find more information at www.uvex-safety.com/uvex1business



Breathable materials



Extra heel padding for a comfortable fit



Ergonomically designed PU outsole

Safety Footwear
uvex 1 business



84281
84282
84283

84697
84698
84699

84271
84272
84273



uvex 1 business · Shoe S2/S3L · Lace-up boot S3L

Do you need to head straight from the meeting room to the production line? uvex's new line of safety shoes brings together three classic looks from the fashion world – Derby shoes, desert boots and Chelsea boots. uvex 1 business safety shoes can go wherever you go, managing to be stylish and safe at the same time! Their attractive appearance blends seamlessly with smart business and casual attire, while their steel cap provides maximum protection with plenty of toe room. Their first-class wearer comfort never fails to impress, from morning to night.

Features:

- PU outsole
- steel protective toe cap

- flexible textile penetration resistance
- lightweight and breathable microvelour upper (8427, 8428)
- breathable textile lining
- ESD certified
- suitable for people allergic to chrome
- removable antistatic comfortable insole (Art. no.: 95157-9)

Sustainability:

- insole and heel cap made wholly or partly from recycled materials
- free from harmful substances in accordance with the uvex restricted substances list

uvex 1 business	Shoe	Shoe	Lace-up boot
Art. no. Width 10	84697	84281	84271
Art. no. Width 11	84698	84282	84272
Art. no. Width 12	84699	84283	84273
Standard EN ISO 20345:2011	S2 SRC	S3 SRC	S3 SRC
Standard EN ISO 20345:2022	S2 FO SR	S3L FO SR	S3L FO SR
Upper	microvelour	microvelour	microvelour
Lining	textile	textile	textile
Fastening	shoe laces	shoe laces	shoe laces
Sizes	39 to 52	39 to 52	39 to 52
Order unit	PR	PR	PR

Safety Footwear

uvex 1 business



84481
84482
84483



84301
84302
84303



84491
84492
84493



uvex 1 business · Shoe S3L

Features:

- PU outsole
- steel protective toe cap
- flexible textile penetration resistance
- lightweight and breathable microvelour upper (8430)
- hydrophobic leather upper (8448, 8449)
- breathable textile lining
- ESD certified

- suitable for people allergic to chrome (8430)
- removable antistatic comfortable insole (Art. no.: 95157-9)

Sustainability:

- insole and heel cap made wholly or partly from recycled materials
- free from harmful substances in accordance with the uvex restricted substances list



uvex 1 business	Shoe	Shoe	Shoe
Art. no. Width 10	84301	84481	84491
Art. no. Width 11	84302	84482	84492
Art. no. Width 12	84303	84483	84493
Standard EN ISO 20345:2011	S3 SRC	S3 SRC	S3 SRC
Standard EN ISO 20345:2022	S3L FO SR	S3L FO SR	S3L FO SR
Upper	microvelour	water-repellent leather	water-repellent leather
Lining	textile	textile	textile
Fastening	shoe laces	shoe laces	shoe laces
Sizes	39 to 52	39 to 52	39 to 52
Order unit	PR	PR	PR

uvex

uvex 1

redefining performance



100% more shock absorption.
Comfort in 3 dimensions.



Outstanding stability.
Reliable support and safety.



uvex monoskin shaft design.
Pressure-free, comfortable fit.



uvex climazone standard.
Temperature and climate control.

Outstanding flexibility. Optimum wearer comfort.

The ergonomic design of the outsole supports the natural movement and flexibility of the feet

High abrasion-resistant TPU sections

Jointed insert for securely climbing ladders.

High flexibility and optimum torsion

Ergonomic sole design

Slip-resistant profile

Safety Footwear

uvex 1



85427
85428
85429
85420



85437
85438
85439
85430



85467
85468
85469



65657
65658
65659



85477
85478
85479



uvex 1 • Sandal S1 • Perforated shoe S1 • Perforated lace-up boot S1

The uvex 1 safety shoe provides robust protection for light applications. Its ergonomic design and seam-free construction prevent pressure points and provide optimal foot protection. The dual-density polyurethane sole offers both shock absorption and comfort. The timeless design is characterised by clean lines and a simplified look.

Features:

- shock-absorbing PU midsole
- PU outsole
- foamed polyurethane heel basket
- 100% metal-free protective toe cap
- lightweight and breathable microvelour upper

- breathable distance mesh lining
- ESD certified
- sizes 35 to 40 produced using a womens' last
- metal-free (Art. no.: 8542, 8547 only)
- suitable for people allergic to chrome
- removable antistatic comfortable insole (Art. no.: 95347-0)

Sustainability:

- insole and removable insole made wholly or partly from recycled materials
- free from harmful substances in accordance with the uvex restricted substances list



uvex 1	Sandal	Perforated shoe	Perforated shoe	Perforated shoe	Perforated lace-up boot
Art. no. Width 10	85427	85437	85467	65657	85477
Art. no. Width 11	85428	85438	85468	65658	85478
Art. no. Width 12	85429	85439	85469	65659	85479
Art. no. Width 14	85420	85430	-	-	-
Standard EN ISO 20345:2011	S1 SRC	S1 SRC	S1 SRC	S1 SRC	S1 SRC
Standard EN ISO 20345:2022	S1 FO SR	S1 FO SR	S1 FO SR	S1 FO SR	S1 FO SR
Upper	microvelour	microvelour	microvelour	microvelour	microvelour
Lining	distance mesh lining	distance mesh lining	distance mesh lining	distance mesh lining	distance mesh lining
Fastening	hook-and-loop fastening	elastic laces	elastic laces	BOA® Fit System	shoe laces
Sizes	35 to 52	35 to 52	35 to 52	35 to 52	35 to 52
Order unit	PR	PR	PR	PR	PR

You can find more information on uvex medicare on pages 430 to 437

Safety Footwear

uvex 1



85447
85448
85449
85440



65667
65668
65669



85457
85458
85459
85450



uvex 1 • Shoe S2 • Lace-up boot S2

Features:

- shock-absorbing PU midsole
- PU outsole
- foamed polyurethane heel basket
- 100% metal-free protective toe cap
- lightweight and breathable microvelour upper
- breathable distance mesh lining
- ESD certified
- sizes 35 to 40 produced using a womens' last

- metal-free (Art. no.: 8545 only)
- suitable for people allergic to chrome
- removable antistatic comfortable insole (Art. no.: 95347-0)

Sustainability:

- insole and removable insole made wholly or partly from recycled materials
- free from harmful substances in accordance with the uvex restricted substances list

uvex 1	Shoe	Shoe	Lace-up boot
Art. no. Width 10	85447	65667	85457
Art. no. Width 11	85448	65668	85458
Art. no. Width 12	85449	65669	85459
Art. no. Width 14	85440	-	85450
Standard EN ISO 20345:2011	S2 SRC	S2 SRC	S2 SRC
Standard EN ISO 20345:2022	S2 FO SR	S2 FO SR	S2 FO SR
Upper	microvelour	microvelour	microvelour
Lining	distance mesh lining	distance mesh lining	distance mesh lining
Fastening	elastic laces	BOA® Fit System	shoe laces
Sizes	35 to 52	35 to 52	35 to 52
Order unit	PR	PR	PR

You can find more information on uvex medicare on pages 430 to 437

Safety Footwear
uvex 1 ladies



85607
85608



85617
85618



85627
85628



uvex 1 ladies - Sandal S1 - Perforated shoe S1 - Shoe S2

Features:

- shock-absorbing PU midsole
- PU outsole
- foamed polyurethane heel basket
- 100% metal-free protective toe cap
- lightweight and breathable microvelour upper
- breathable distance mesh lining
- ESD certified
- sizes 35 to 40 produced using a womens' last

- metal-free (Art. no.: 8560 only)
- suitable for people allergic to chrome
- removable antistatic comfortable insole (Art. no.: 95347-0)

Sustainability:

- insole and removable insole made wholly or partly from recycled materials
- free from harmful substances in accordance with the uvex restricted substances list



uvex 1	Sandal	Perforated shoe	Shoe
Art. no. Width 10	85607	85617	85627
Art. no. Width 11	85608	85618	85628
Standard EN ISO 20345:2011	S1 SRC	S1 SRC	S2 SRC
Standard EN ISO 20345:2022	S1 FO SR	S1 FO SR	S2 FO SR
Upper	microvelour	microvelour	microvelour
Lining	distance mesh lining	distance mesh lining	distance mesh lining
Fastening	hook-and-loop fastening	elastic laces	elastic laces
Sizes	35 to 52	35 to 52	35 to 52
Order unit	PR	PR	PR

Safety Footwear

uvex 1 x-tended support



85361
85362
85363

85127
85128
85129

85117
85118
85119

85141
85142
85143

85191
85192
85193

65681
65682
65683



clima zone



uvex 1 x-tended support · Sandal S1 PL · Perforated Shoe S1 PL/S1

Features:

- shock-absorbing PU midsole
- PU outsole
- foamed polyurethane scuffcap (8514, 8519, 8536, 6568)
- foamed polyurethane heel basket
- 100% metal-free protective toe cap
- flexible textile penetration resistance (8514, 8519, 8536, 6568)
- lightweight and breathable microvelour upper
- breathable distance mesh lining
- ESD certified

- dust tongue (not 8536)
- sizes 35 to 40 produced using a womens' last
- metal-free (Art. no.: 8536 only)
- suitable for people allergic to chrome
- removable antistatic comfortable insole (Art. no.: 95347-0)

Sustainability:

- insole made wholly or partly from recycled materials
- free from harmful substances in accordance with the uvex restricted substances list

uvex 1 x-tended support	Sandal	Perforated shoe	Perforated shoe	Perforated shoe	Perforated shoe	Perforated shoe
Art. no. Width 10	85361	85127	85117	85141	85191	65681
Art. no. Width 11	85362	85128	85118	85142	85192	65682
Art. no. Width 12	85363	85129	85119	85143	85193	65683
Norm EN ISO 20345:2011	S1 P SRC	S1 SRC	S1 SRC	S1 P SRC	S1 P SRC	S1 P SRC
Norm EN ISO 20345:2022	S1 PL FO SC SR	S1 FO SR	S1 FO SR	S1 PL FO SC SR	S1 PL FO SC SR	S1 PL FO SC SR
Upper	microvelour	microvelour	microvelour	microvelour	microvelour	microvelour
Lining	distance mesh lining	distance mesh lining	distance mesh lining	distance mesh lining	distance mesh lining	distance mesh lining
Fastening	hook-and-loop fastening	elastic laces	elastic laces	elastic laces	elastic laces	BOA® Fit System
Sizes	35 to 52	35 to 52	35 to 52	35 to 52	35 to 52	35 to 52
Bestelleinheit	PR	PR	PR	PR	PR	PR

You can find more information on uvex medicare on pages 430 to 437

Safety Footwear

uvex 1 x-tended support



85161
85162
85163



65671
65672
65673



85171
85172
85173



uvex 1 x-tended support · Shoe S3L · Lace-up boot S3L

Features:

- shock-absorbing PU midsole
- PU outsole
- foamed polyurethane scuffcap
- foamed polyurethane heel basket
- 100% metal-free protective toe cap
- flexible textile penetration resistance
- lightweight and breathable microvelour upper
- breathable distance mesh lining
- ESD certified

- dust tongue
- sizes 35 to 40 produced using a womens' last
- metal-free (Art. no.: 8517 only)
- suitable for people allergic to chrome
- removable antistatic comfortable insole (Art. no.: 95347-0)

Sustainability:

- insole made wholly or partly from recycled materials
- free from harmful substances in accordance with the uvex restricted substances list



uvex 1 x-tended support	Shoe	Shoe	Lace-up boot
Art. no. Width 10	85161	65671	85171
Art. no. Width 11	85162	65672	85172
Art. no. Width 12	85163	65673	85173
Standard EN ISO 20345:2011	S3 SRC	S3 SRC	S3 SRC
Standard EN ISO 20345:2022	S3L FO SC SR	S3L FO SC SR	S3L FO SC SR
Upper	microvelour	microvelour	microvelour
Lining	distance mesh lining	distance mesh lining	distance mesh lining
Fastening	elastic laces	BOA® Fit System	shoe laces
Sizes	35 to 52	35 to 52	35 to 52
Order unit	PR	PR	PR

You can find more information on uvex medicare on pages 430 to 437

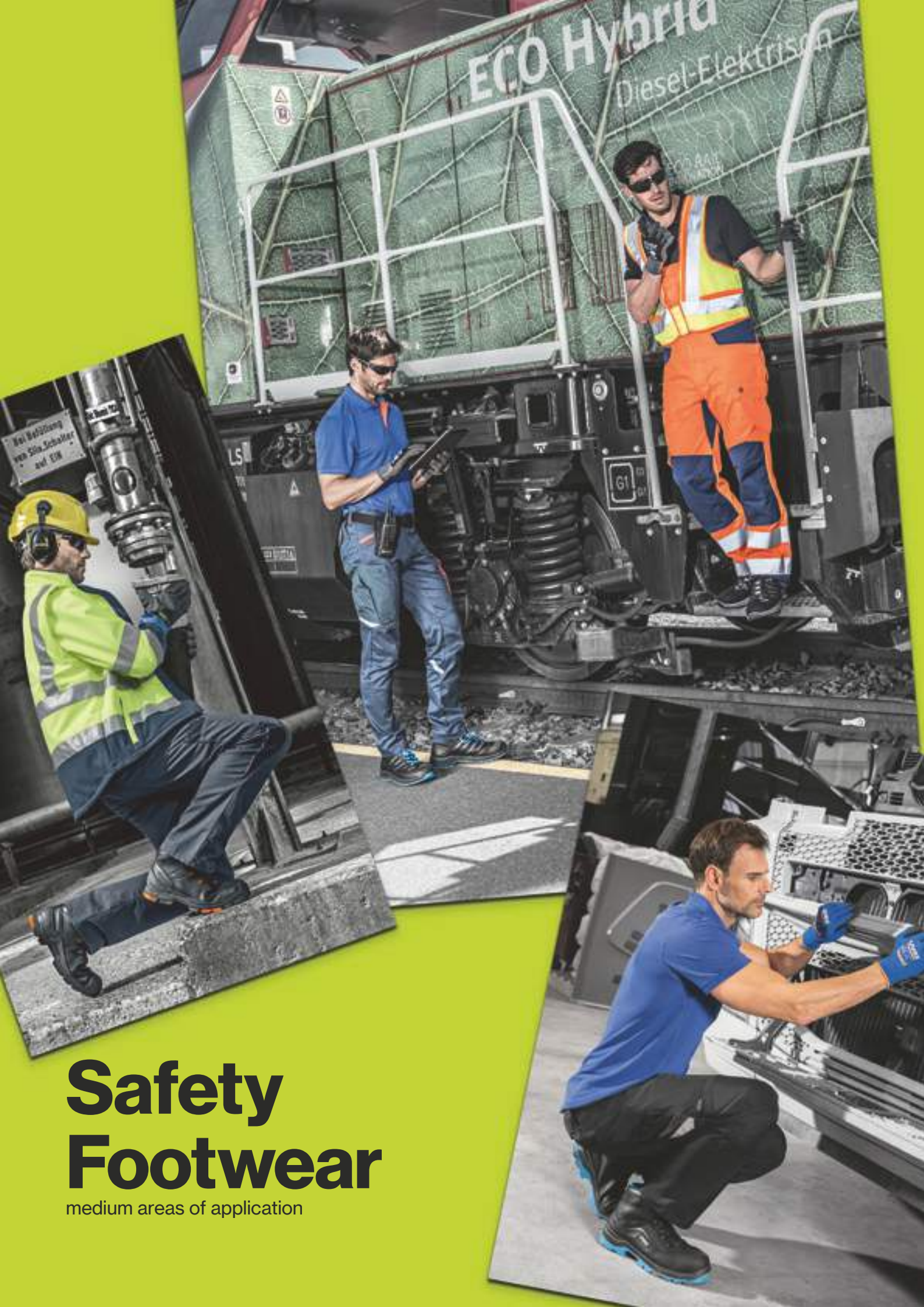

ECO Hybrid
Diesel-Elektrisch

Bei Bedienung
von Stoßschalter
auf EN

Safety Footwear

medium areas of application



Pushing the Limits!

Superior performance across all disciplines

The innovative uvex 2 safety shoe series does not shy away from any challenge among medium applications: robust upper materials and a deep sole profile ensure maximum performance in your everyday work. The lightweight design, flexible sole and breathability ensure comfort all day long.

Website



Full sole flexibility



Quick-release laces can be adjusted to fit any foot



Directly moulded PU scuffcap reliably protects the upper



High stability thanks to integrated heel basket

Safety Footwear

uvex 2



65021
65022
65023
65024



65031
65032
65033
65034



uvex 2 · Shoe S3L · Lace-up boot S3L

Features:

- shock-absorbing PU midsole
- PU outsole
- foamed polyurethane scuffcap
- foamed polyurethane heel basket
- 100% metal-free protective toe cap
- flexible textile penetration resistance
- hydrophobic leather upper
- breathable distance mesh lining
- reflective elements

- ESD certified
- dust tongue
- sizes 35 to 40 produced using a womens' last
- metal-free (Art. no.: 6503 only)
- removable antistatic comfortable insole (Art. no.: 95347-0)

Sustainability:

- insole made wholly or partly from recycled materials
- free from harmful substances in accordance with the uvex restricted substances list

uvex 2	Shoe	Lace-up boot
Art. no. Width 10	65021	65031
Art. no. Width 11	65022	65032
Art. no. Width 12	65023	65033
Art. no. Width 14	65024	65034
Standard EN ISO 20345:2011	S3 SRC	S3 SRC
Standard EN ISO 20345:2022	S3L FO SC SR	S3L FO SC SR
Upper	water-repellent, full-grain smooth leather	water-repellent, full-grain smooth leather
Lining	distance mesh lining	distance mesh lining
Fastening	elastic laces	shoe laces
Sizes	35 to 52	35 to 52
Order unit	PR	PR

You can find more information on uvex medicare on pages 430 to 437

Safety Footwear

uvex 2



65001
65002
65003
65004

65011
65012
65013
65014

65081
65082
65083
65084

65091
65092
65093
65094



uvex 2 · Sandal S1 PL · Perforated shoe S1 PL · Shoe S3L · Lace-up boot S3L

Features:

- shock-absorbing PU midsole
- PU outsole
- foamed polyurethane scuffcap
- foamed polyurethane heel basket
- 100% metal-free protective toe cap
- flexible textile penetration resistance
- lightweight and breathable microvelour upper
- breathable distance mesh lining
- reflective elements
- ESD certified

- dust tongue
- sizes 35 to 40 produced using a womens' last
- metal-free (Art. no.: 6500, 6509 only)
- suitable for people allergic to chrome
- removable antistatic comfortable insole (Art. no.: 95347-0)

Sustainability:

- insole made wholly or partly from recycled materials
- free from harmful substances in accordance with the uvex restricted substances list



uvex 2	Sandal	Perforated Shoe	Shoe	Lace-up boot
Art. no. Width 10	65001	65011	65081	65091
Art. no. Width 11	65002	65012	65082	65092
Art. no. Width 12	65003	65013	65083	65093
Art. no. Width 14	65004	65014	65084	65094
Standard EN ISO 20345:2011	S1 P SRC	S1 P SRC	S3 SRC	S3 SRC
Standard EN ISO 20345:2022	S1 PL FO SC SR	S1 PL FO SC SR	S3L FO SC SR	S3L FO SC SR
Upper	microvelour	microvelour	microvelour	microvelour
Lining	distance mesh lining	distance mesh lining	distance mesh lining	distance mesh lining
Fastening	hook-and-loop fastening	elastic laces	elastic laces	shoe laces
Sizes	35 to 52	35 to 52	35 to 52	35 to 52
Order unit	PR	PR	PR	PR

Safety Footwear

uvex 2 MACSOLE®



65221
65222
65223
65224



65311
65312
65313



65231
65232
65233
65234



65321
65322
65323





65363





65303

clima zone



uvex 2 MACSOLE® · Shoe S3L · Lace-up boot S3L

All the advantages of the uvex 2 safety shoe range combined with a MACSOLE® rubber outsole: The uvex 2 MACSOLE® is characterised by outstanding resistance to heat, chemicals and cuts. In addition, the MACSOLE® rubber sole technology features an unparalleled level of slip resistance, even in cold conditions.

Features:

- shock-absorbing PU midsole
- heat-, chemical- and cut-resistant uvex MACSOLE® rubber outsole
- foamed polyurethane scuffcap
- foamed polyurethane heel basket
- 100% metal-free protective toe cap
- flexible textile penetration resistance
- hydrophobic leather upper

- breathable distance mesh lining (6522, 6523, 6531, 6532)
- warm winter lining (6530, 6536)
- reflective elements (6522, 6523, 6530)
- ESD certified
- dust tongue
- sizes 35 to 40 produced using a womens' last
- metal-free (Art. no.: 6523, 6530 only)
- removable antistatic comfortable insole (Art. no.: 95347-0)

Sustainability:

- insole made wholly or partly from recycled materials
- free from harmful substances in accordance with the uvex restricted substances list

uvex 2 MACSOLE®	Shoe	Shoe	Lace-up boot	Lace-up boot	Winter lace-up boot	Winter lace-up boot
Art. no. Width 10	65221	65311	65231	65321	-	-
Art. no. Width 11	65222	65312	65232	65322	-	-
Art. no. Width 12	65223	65313	65233	65323	65363	65303
Art. no. Width 14	65224	-	65234	-	-	-
Standard EN ISO 20345:2011	S3 HI HRO SRC	S3 HI HRO SRC	S3 HI HRO SRC	S3 HI HRO SRC	S3 CI HI HRO SRC	S3 CI HI HRO SRC
Standard EN ISO 20345:2022	S3L FO HI HRO SC SR	S3L FO HI HRO SC SR	S3L FO HI HRO SC SR	S3L FO HI HRO SC SR	S3L FO CI HI HRO SC SR	S3L FO CI HI HRO SC SR
Upper	water-repellent, full-grain smooth leather	water-repellent, full-grain smooth leather	water-repellent, full-grain smooth leather	water-repellent, full-grain smooth leather	water-repellent, full-grain smooth leather	water-repellent, full-grain smooth leather
Lining	distance mesh lining	distance mesh lining	distance mesh lining	distance mesh lining	distance mesh lining	distance mesh lining
Fastening	elastic laces	BOA® Fit System	shoe laces	BOA® Fit System	BOA® Fit System	shoe laces
Sizes	35 to 52	35 to 52	35 to 52	35 to 52	35 to 52	35 to 52
Order unit	PR	PR	PR	PR	PR	PR

You can find more information on uvex medicare on pages 430 to 437

Safety Footwear
uvex 2 MACSOLE®



65241
65242
65243

65251
65252
65253

65281
65282
65283
65284

65291
65292
65293
65294

sympatex®

sympatex®

clima zone



uvex 2 MACSOLE® · Shoe S7L/S3L · Lace-up boot S7L/S3L

Features:

- shock-absorbing PU midsole
- heat-, chemical- and cut-resistant uvex MACSOLE® rubber outsole
- foamed polyurethane scuffcap
- foamed polyurethane heel basket
- 100% metal-free protective toe cap
- flexible textile penetration resistance
- lightweight and breathable microvelour upper
- breathable distance mesh lining (6528, 6529)
- waterproof sympatex® lining (6524, 6525)
- reflective elements
- ESD certified

• dust tongue

- sizes 35 to 40 produced using a womens' last
- metal-free (Art. no.: 6528, 6529 only)
- suitable for people allergic to chrome
- removable antistatic comfortable insole (Art. no.: 95347-0)

Sustainability:

- insole made wholly or partly from recycled materials
- free from harmful substances in accordance with the uvex restricted substances list



uvex 2 STX MACSOLE®	Shoe	Lace-up boot	Shoe	Lace-up boot
Art.-Nr. Weite 10	65241	65251	65281	65291
Art.-Nr. Weite 11	65242	65252	65282	65292
Art.-Nr. Weite 12	65243	65253	65283	65293
Art.-Nr. Weite 14	-	-	65284	65294
Norm EN ISO 20345:2011	S3 WR HI HRO SRC	S3 WR HI HRO SRC	S3 HI HRO SRC	S3 HI HRO SRC
Norm EN ISO 20345:2022	S7L FO HI HRO SC SR	S7L FO HI HRO SC SR	S3L FO HI HRO SC SR	S3L FO HI HRO SC SR
Upper	microvelour	microvelour	microvelour	microvelour
Lining	sympatex® laminate	sympatex® laminate	distance mesh lining	distance mesh lining
Fastening	elastic laces	shoe laces	elastic laces	shoe laces
Sizes	35 to 52	35 to 52	35 to 52	35 to 52
Order unit	PR	PR	PR	PR

You can find more information on uvex medicare on pages 430 to 437

uvex

uvex 2 construction



The essential allrounder



► uvex recommends footwear with steel midsoles for demanding applications such as construction and construction-related industries.



uvex waterstop technology
Reliable protection against water penetration for four times longer



Stability and ankle protection
Anatomically shaped heel basket
Protection against twisted ankles on uneven surfaces



Increased visibility
Reflective side strips
Increased visibility in many work environments

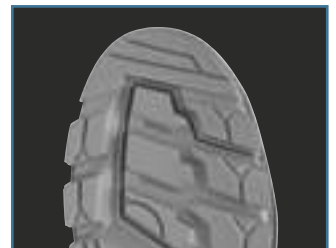

Safe slip resistance
Deep sole tread
Reliable slip resistance and grip

Safety Footwear

uvex 2 construction



uvex 2 construction · Lace-up boot S3

The new uvex 2 construction was developed to meet the specific challenges of the construction industry. The construction and engineering industries really put workers and their footwear to the test. In addition to high mechanical stress, extreme weather conditions are often a factor too. Thanks to their intelligent design and innovative technologies, the uvex 2 construction models offer reliable protection, stability and exceptional comfort.

Features:

- shock-absorbing PU midsole
- PU outsole
- foamed polyurethane scuffcap
- foamed polyurethane heel basket
- 100% metal-free protective toe cap

- steel penetration resistance
- water-resistant uvex waterstop leather upper
- breathable distance mesh lining
- reflective elements
- dust tongue
- sizes 35 to 40 produced using a womens' last
- removable antistatic comfortable insole (Art. no.: 95347-0)

Sustainability:

- insole and removable insole made wholly or partly from recycled materials
- free from harmful substances in accordance with the uvex restricted substances list



uvex 2 construction	Lace-up boot	Lace-up boot	Lace-up boot
Art. no. Width 10	65101	65121	65131
Art. no. Width 11	65102	65122	65132
Art. no. Width 12	65103	65123	65133
Standard EN ISO 20345:2011	S3 SRC	S3 SRC	S3 SRC
Standard EN ISO 20345:2022	S3 FO SC SR	S3 FO SC SR	S3 FO SC SR
Upper	water repellent leather	water repellent leather	water repellent leather
Lining	textile	textile	textile
Fastening	shoe laces	shoe laces	shoe laces
Sizes	35 to 52	35 to 52	35 to 52
Order unit	PR	PR	PR

uvex

uvex 2 xenova®

uvex 2 xenova® Trend-setting all-rounder



You can find more information at www.uvex-safety.com/uvex2xenova



Metal-free protective toe cap and optional metal-free penetration resistance



Breathable upper

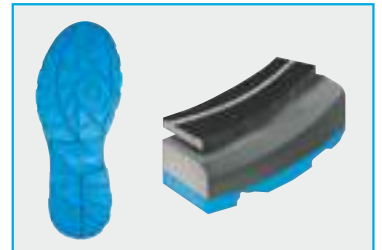

Lightweight and robust dual-density polyurethane sole

Safety Footwear

uvex 2 xenova®



S1 P | 95531 | **S1** | 95537
 95532 | 95538
 95533 | 95539

95547
 95548
 95549

95581
 95582
 95583



95577
 95578
 95579

clima zone



uvex 2 xenova® · Sandal S1 PL/S1 · Perforated shoe S1/S1 PL · Shoe S2

Improved comfort, guaranteed protection and an attractive design: All of this is offered by the new and completely metal-free uvex 2 xenova® safety shoes. An improved fit, lighter weight and optimum shock absorption, breathability and padding significantly increase wearer comfort. The combination of protection, style and comfort makes the new uvex 2 xenova® a popular all-rounder for indoor and outdoor work, for example in mechanical and plant engineering, metalworking or handicraft work.

Features:

- shock-absorbing PU midsole
- PU outsole
- 100% metal-free protective toe cap
- flexible textile penetration resistance (95531-3, 9558)
- lightweight and breathable microvelour upper

- breathable distance mesh lining
- reflective elements
- ESD certified
- dust tongue (9554, 9557, 9558)
- sizes 38 to 40 produced using a womens' last
- metal-free (Art. no.: 9553, 9554, 9557 only)
- suitable for people allergic to chrome
- removable antistatic comfortable insole (Art. no.: 95347-0)

Sustainability:

- insole and heel cap made wholly or partly from recycled materials
- free from harmful substances in accordance with the uvex restricted substances list



uvex 2 xenova®	Sandal	Sandal	Perforated shoe	Perforated shoe	Shoe
Art. no. Width 10	95531	95537	95547	95581	95577
Art. no. Width 11	95532	95538	95548	95582	95578
Art. no. Width 12	95533	95539	95549	95583	95579
Standard EN ISO 20345:2011	S1 P SRC	S1 SRC	S1 SRC	S1 P SRC	S2 SRC
Standard EN ISO 20345:2022	S1 PL FO SR	S1 FO SR	S1 FO SR	S1 PL FO SR	S2 FO SR
Upper	microvelour	microvelour	microvelour	microvelour	microvelour
Lining	distance mesh lining	distance mesh lining	distance mesh lining	distance mesh lining	distance mesh lining
Fastening	hook-and-loop fastening	hook-and-loop fastening	shoe laces	BOA® Fit System	shoe laces
Sizes	38 to 52	38 to 52	38 to 52	38 to 52	38 to 52
Order unit	PR	PR	PR	PR	PR

Safety Footwear

uvex 2 xenova®



95557
95558
95559



95551
95552
95553



95561
95562
95563



95691
95692
95693 



uvex 2 xenova® · Shoe S2/S3L · Lace-up boot S3L

Features:

- shock-absorbing PU midsole
- PU outsole
- 100% metal-free protective toe cap
- flexible textile penetration resistance
- hydrophobic leather upper
- scuffcap with PU coating (95551-3, 9556, 9569)
- breathable distance mesh lining
- reflective elements
- ESD certified

dust tongue

- sizes 38 to 40 produced using a womens' last
- metal-free (Art. no.: 9555, 9556 only)
- removable antistatic comfortable insole (Art. no.: 95347-0)

Sustainability:

- insole and heel cap made wholly or partly from recycled materials
- free from harmful substances in accordance with the uvex restricted substances list

uvex 2 xenova®	Shoe	Shoe	Lace-up boot	Lace-up boot
Art. no. Width 10	95557	95551	95561	95691
Art. no. Width 11	95558	95552	95562	95692
Art. no. Width 12	95559	95553	95563	95693
Standard EN ISO 20345:2011	S2 SRC	S3 SRC	S3 SRC	S3 SRC
Standard EN ISO 20345:2022	S2 FO SR	S3L FO SC SR	S3L FO SC SR	S3L FO SC SR
Upper	water-repellent, full-grain leather	water-repellent, full-grain leather	water-repellent, full-grain leather	water-repellent, full-grain leather
Lining	distance mesh lining	distance mesh lining	distance mesh lining	distance mesh lining
Fastening	shoe laces	shoe laces	shoe laces	BOA® Fit System
Sizes	38 to 52	38 to 52	38 to 52	38 to 52
Order unit	PR	PR	PR	PR

You can find more information on uvex medicare on pages 430 to 437

Safety and comfort redefined – uvex 2 trend

Affordable Quality and Comfort

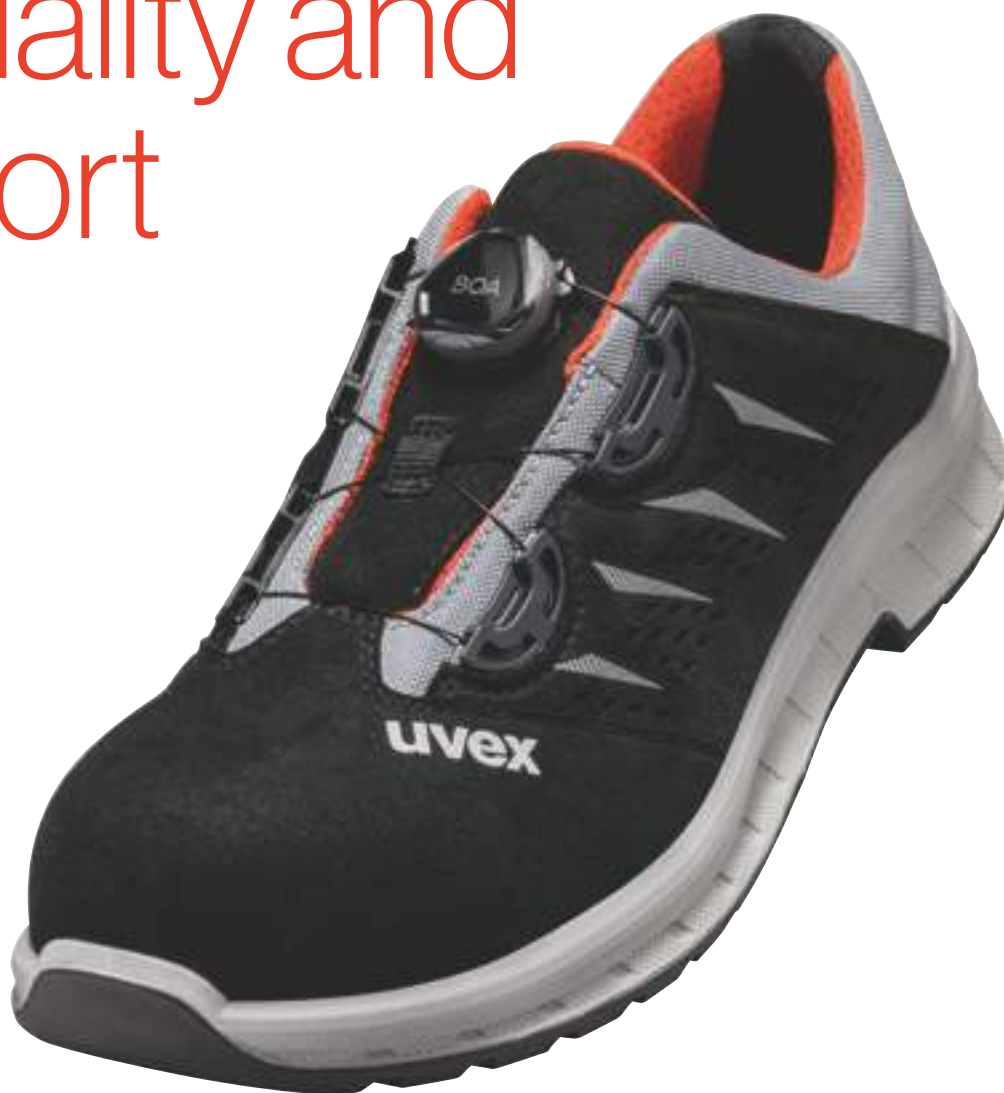

You can find more information at www.uvex-safety.com/uvex2trend



Lightweight and robust dual-density polyurethane sole



Breathable upper



Steel protective toe cap and optional steel penetration resistance*



Reliable ankle protection thanks to integrated heel cap

* on selected models

Safety Footwear

uvex 2 trend



S1 P | 69361
69362
69363

S1 | 69367
69368
69369

69061
69062
69063

69381
69382
69383



69081
69082
69083



clima zone



uvex 2 trend · Sandal S1 P/S1 · Perforated shoe S1 P

Whether in the assembly hall or on the production line, indoors or outdoors: uvex 2 trend safety shoes are equipped with numerous proven technologies in a modern entry-level product line for medium applications. The product family relies on steel protective elements. In addition, the uvex anti-twist heel cap provides greater protection against twisted ankles, while the polyurethane outsole ensures wearer comfort. The result: maximum comfort and reliable safety for your everyday work.

Features:

- shock-absorbing PU midsole
- PU outsole
- steel protective toe cap
- steel penetration resistance (6906, 69361-3, 6908, 6938)

- lightweight and breathable microvelour upper
- breathable distance mesh lining
- reflective elements
- ESD certified
- dust tongue (6908, 6938)
- sizes 36 to 40 produced using a womens' last
- suitable for people allergic to chrome
- removable antistatic comfortable insole (Art. no.: 95187-9)

Sustainability:

- insole and heel cap made wholly or partly from recycled materials
- free from harmful substances in accordance with the uvex restricted substances list

uvex 2 trend	Sandal	Sandal	Sandal	Perforated shoe	Perforated shoe
Art. no. Width 10	69361	69367	69061	69381	69081
Art. no. Width 11	69362	69368	69062	69382	69082
Art. no. Width 12	69363	69369	69063	69383	69083
Standard EN ISO 20345:2011	S1 P SRC	S1 SRC	S1 P SRC	S1 P SRC	S1 P SRC
Standard EN ISO 20345:2022	S1 P FO SR	S1 FO SR	S1 P FO SR	S1 P FO SR	S1 P FO SR
Upper	microvelour	microvelour	microvelour	microvelour	microvelour
Lining	distance mesh lining	distance mesh lining	distance mesh lining	distance mesh lining	distance mesh lining
Fastening	hook-and-loop fastening	hook-and-loop fastening	hook-and-loop fastening	BOA® Fit System	BOA® Fit System
Sizes	36 to 52	36 to 52	38 to 52	36 to 52	38 to 52
Order unit	PR	PR	PR	PR	PR

You can find more information on uvex medicare on pages 430 to 437

Safety Footwear

uvex 2 trend



S1 P | 69371
69372
69373 | **S1** | 69377
69378
69379

69477
69478
69479

69397
69398
69399

69497
69498
69499



uvex 2 trend - Perforated shoe S1 P/S1 - Shoe S2

Features:

- shock-absorbing PU midsole
- PU outsole
- steel protective toe cap
- steel penetration resistance (69371-3)
- lightweight and breathable microvelour upper
- breathable distance mesh lining
- reflective elements
- ESD certified

- dust tongue
- sizes 36 to 40 produced using a womens' last
- suitable for people allergic to chrome
- removable antistatic comfortable insole (Art. no.: 95187-9)

Sustainability:

- insole and heel cap made wholly or partly from recycled materials
- free from harmful substances in accordance with the uvex restricted substances list



uvex 2 trend	Perforated shoe	Perforated shoe	Perforated shoe	Shoe	Shoe
Art. no. Width 10	69371	69377	69477	69397	69497
Art. no. Width 11	69372	69378	69478	69398	69498
Art. no. Width 12	69373	69379	69479	69399	69499
Standard EN ISO 20345:2011	S1 P SRC	S1 SRC	S1 SRC	S2 SRC	S2 SRC
Standard EN ISO 20345:2022	S1 P FO SR	S1 FO SR	S1 FO SR	S2 FO SR	S2 FO SR
Upper	microvelour	microvelour	microvelour	microvelour	microvelour
Lining	distance mesh lining	distance mesh lining	distance mesh lining	distance mesh lining	distance mesh lining
Fastening	shoe laces	shoe laces	shoe laces	shoe laces	shoe laces
Sizes	36 to 52	36 to 52	38 to 52	36 to 52	38 to 52
Order unit	PR	PR	PR	PR	PR

Safety Footwear
uvex 2 trend



69347
69348
69349

69341
69342
69343

69357
69358
69359

69351
69352
69353



uvex 2 trend · Shoe S2/S3 · Lace-up boot S2/S3

Features:

- shock-absorbing PU midsole
- PU outsole
- foamed polyurethane scuffcap
- steel protective toe cap
- steel penetration resistance (69341-3, 69351-3)
- hydrophobic leather upper
- breathable distance mesh lining
- reflective elements

- ESD certified
- dust tongue
- sizes 36 to 40 produced using a womens' last
- removable antistatic comfortable insole (Art. no.: 95187-9)

Sustainability:

- insole and heel cap made wholly or partly from recycled materials
- free from harmful substances in accordance with the uvex restricted substances list

uvex 2 trend	Shoe	Shoe	Lace-up boot	Lace-up boot
Art. no. Width 10	69347	69341	69357	69351
Art. no. Width 11	69348	69342	69358	69352
Art. no. Width 12	69349	69343	69359	69353
Standard EN ISO 20345:2011	S2 SRC	S3 SRC	S2 SRC	S3 SRC
Standard EN ISO 20345:2022	S2 FO SR	S3 FO SR	S2 FO SR	S3 FO SR
Upper	full-grain soft leather	full-grain soft leather	full-grain soft leather	full-grain soft leather
Lining	distance mesh lining	distance mesh lining	distance mesh lining	distance mesh lining
Fastening	shoe laces	shoe laces	shoe laces	shoe laces
Sizes	36 to 52	36 to 52	36 to 52	36 to 52
Order unit	PR	PR	PR	PR

You can find more information on uvex medicare on pages 430 to 437



Safety Footwear

heavy areas of application

uvex

uvex 3 – safety and comfort made easy.

Hard work.
Easy going.



reddot winner 2022



uvex anklepro
Protection against impacts in the ankle area



uvex lancelock
Optimised lacing for increased stability with locking lace hooks



uvex waterstop Technologie
Reliable protection against water penetration for four times longer

Safety Footwear

uvex 3



68711
68712
68713

68741
68742
68743



reddot winner 2022

bionom x clima zone i-PUREnrj



uvex 3 · Shoe S3L · Lace-up boot S3L

The uvex 3 is the ideal companion for heavy-duty applications. It combines the necessary robustness with a sporty and dynamic design. The uvex bionom x design ensures that upper and outsole offer optimum wearer comfort. Additional features also provide outstanding protection.

Features:

- uvex i-PUREnrj midsole with shock-absorption and energy-return features
- PU outsole
- foamed polyurethane scuffcap
- foamed polyurethane heel basket
- 100% metal-free protective toe cap
- flexible textile penetration resistance
- water-resistant uvex waterstop leather upper

- breathable textile lining
- uvex anklepro ankle protection (68741)
- uvex lacelock fastening hook (6874)
- reflective elements
- ESD certified
- dust tongue
- sizes 36 to 40 produced using a womens' last
- removable antistatic comfortable insole (Art. no.: 86937-9)

Sustainability:

- insole made wholly or partly from recycled materials
- free from harmful substances in accordance with the uvex restricted substances list

uvex 3	Shoe	Lace-up boot
Art. no. Width 10	68711	68741
Art. no. Width 11	68712	68742
Art. no. Width 12	68713	68743
Standard EN ISO 20345:2011	-	S3 CI SRC
Standard EN ISO 20345:2022	S3L FO CI SC SR	S3L FO CI SC SR
Upper	water repellent leather	water repellent leather
Lining	textile	textile
Fastening	shoe laces	shoe laces
Sizes	36 to 52	36 to 52
Order unit	PR	PR

Safety Footwear

uvex 3



68721
68722
68723

68731
68732
68733

68751
68752
68753



reddot winner 2022

bionom x clima zone i-PUREnrj



uvex 3 · Lace-up boot S3 · High lace-up boot S3

Features:

- uvex i-PUREnrj midsole with shock-absorption and energy-return features
- PU outsole
- foamed polyurethane scuffcap
- foamed polyurethane heel basket
- 100% metal-free protective toe cap
- steel penetration resistance
- water-resistant uvex waterstop leather upper
- breathable textile lining
- uvex anklepro ankle protection
- uvex lacelock fastening hook
- reflective elements
- ESD certified

- dust tongue
- sizes 36 to 40 produced using a womens' last
- removable antistatic comfortable insole (Art. no.: 86937-9)

Sustainability:

- insole and removable insole made wholly or partly from recycled materials
- free from harmful substances in accordance with the uvex restricted substances list

► **uvex recommends footwear with steel midsoles for demanding applications such as construction and construction-related industries.**

uvex 3	Lace-up boot	Lace-up boot	High lace-up boot
Art. no. Width 10	68721	68731	68751
Art. no. Width 11	68722	68732	68752
Art. no. Width 12	68723	68733	68753
Standard EN ISO 20345:2011	S3 CI SRC	S3 CI SRC	-
Standard EN ISO 20345:2022	S3 FO CI SC SR	S3 FO CI SC SR	S3 FO CI SC SR
Upper	water repellent leather	water repellent leather	water repellent leather
Lining	textile	textile	textile
Fastening	shoe laces	shoe laces	shoe laces
Sizes	36 to 52	36 to 52	36 to 52
Order unit	PR	PR	PR

Safety Footwear

uvex 3



68771
68772
68773



68781
68782
68783

bionom x clima zone i-PUREnrj



uvex 3 · High lace-up boot S3L CI · High zip-up boot S3L CI

Features:

- uvex i-PUREnrj midsole with shock-absorption and energy-return features
- PU outsole
- foamed polyurethane scuffcap
- foamed polyurethane heel basket
- 100% metal-free protective toe cap
- flexible textile penetration resistance
- water-resistant uvex waterstop leather upper
- warm winter lining
- uvex anklepro ankle protection (6877)

- uvex lacelock fastening hook (6877)
- reflective elements
- ESD certified
- dust tongue (6877)
- sizes 36 to 40 produced using a womens' last
- removable antistatic comfortable insole (Art. no.: 86937-9)

Sustainability:

- removable insole made wholly or partly from recycled materials
- free from harmful substances in accordance with the uvex restricted substances list



uvex 3	High lace-up boot	High zip-up boot
Art. no. Width 10	68771	68781
Art. no. Width 11	68772	68782
Art. no. Width 12	68773	68783
Standard EN ISO 20345:2011	-	-
Standard EN ISO 20345:2022	S3L FO CI SC SR	S3L FO CI SC SR
Upper	water repellent leather	water repellent leather
Lining	warm lining	warm lining
Fastening	shoe laces	zip
Sizes	36 to 52	36 to 52
Order unit	PR	PR

uvex

uvex 3 Macsole®

Sustainable rubber technology



planet up to
30%
recycled rubber



#Weave
SEE THE LIGHTER SIDE

10%
less weight



Contact heat resistant short-term up to 300° Celsius and heat-insulating



Flexible, even at low temperatures



Extremely slip-resistant, cut-resistant and largely chemical-resistant

Safety Footwear

uvex 3 MACSOLE®



68601
68602
68603

68611
68612
68613

68621
68622
68623 **sympatex®**

68631
68632
68633 **sympatex®**



bionom x clima zone i-PUREnrj

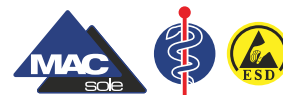

uvex 3 MACSOLE® - Shoe S3/S7 · Lace-up boot S3/S7

The uvex 3, but even more robust. The MACSOLE® rubber outsole provides even stronger support for heavy-duty applications, making it particularly resistant to heat, chemicals and cuts. In addition, the MACSOLE® rubber sole technology features an unparalleled level of slip resistance, even in cold conditions.

Features:

- uvex i-PUREnrj midsole with shock-absorption and energy-return features
- heat-, chemical- and cut-resistant uvex MACSOLE® rubber outsole
- foamed polyurethane scuffcap
- foamed polyurethane heel basket
- 100% metal-free protective toe cap
- steel penetration resistance
- hydrophobic leather upper (6862, 6863)
- water-resistant uvex waterstop leather upper (6860, 6861)

- waterproof Sympatex lining (6862, 6863)
- breathable textile lining (6860, 6861)
- uvex anklepro ankle protection (6861, 6863)
- uvex lacelock fastening hook (6861, 6863)
- reflective elements
- ESD certified
- dust tongue
- sizes 36 to 40 produced using a womens' last
- removable antistatic comfortable insole (Art. no.: 86937-9)

Sustainability:

- insole and removable insole made wholly or partly from recycled materials
- free from harmful substances in accordance with the uvex restricted substances list



uvex 3 MACSOLE®	Shoe	Lace-up boot	Shoe	Lace-up boot
Art. no. Width 10	68601	68611	68621	68631
Art. no. Width 11	68602	68612	68622	68632
Art. no. Width 12	68603	68613	68623	68633
Standard EN ISO 20345:2011	-	-	-	-
Standard EN ISO 20345:2022	S3 FO CI HI HRO SC SR	S3 FO CI HI HRO SC SR	S7 FO CI HI HRO SC SR	S7 FO CI HI HRO SC SR
Upper	water repellent leather	water repellent leather	water repellent leather	water repellent leather
Lining	textile	textile	sympatex® laminate	sympatex® laminate
Fastening	shoe laces	shoe laces	shoe laces	shoe laces
Sizes	36 to 52	36 to 52	36 to 52	36 to 52
Order unit	PR	PR	PR	PR

You can find more information on uvex medicare on pages 430 to 437

uvex 3 asphaltpro

Reliable protection for extremely challenging applications



Reflective side strips
for increased visibility



Outsole with flat tread
to avoid tread marks



Heat-insulating insole
thanks to film in the forefoot area



Anatomically shaped heel basket
for stability and ankle protection



Heat resistance +300 °C (HRO)

Heat resistance testet at +300 °C (HRO)
Heat insulation testet at +150 °C (HI)
and at +250 °C (HI-3 according to standard
DIN EN ISO 20349-1 passed, not certifiable)



Safety Footwear

uvex 3 asphaltpro



65591
65592
65593

clima zone



uvex 3 asphaltpro · Lace-up boot S3 HI HRO

Designed for the extreme challenges of asphalt work with really high temperatures. The highlight is the sole made from special heat-insulating and heat-resistant materials. The high-quality leather upper with uvex waterstop technology and steel sole for perforation protection provide reliable protection against external influences. Its ergonomic fit, lightweight design and optimum climate characteristics make it the perfect partner for road construction work.

Features:

- shock-absorbing PU midsole
- heat-, chemical- and cut-resistant uvex MACSOLE® rubber outsole
- foamed polyurethane heel basket

- 100% metal-free protective toe cap
- steel penetration resistance
- water-resistant uvex waterstop leather upper
- breathable textile lining
- reflective elements
- dust tongue
- removable antistatic comfortable insole (Art. no.: 94597-9)

Sustainability:

- removable insole made wholly or partly from recycled materials
- free from harmful substances in accordance with the uvex restricted substances list



uvex 3 asphaltpro	Lace-up boot
Art. no. Width 10	65591
Art. no. Width 11	65592
Art. no. Width 12	65593
Standard EN ISO 20345:2011	S3 HI HRO SRA
Standard EN ISO 20345:2022	S3 FO HI HRO
Upper	water repellent leather
Lining	textile
Fastening	shoe laces
Sizes	38 to 50
Order unit	PR

You can find more information on uvex medicare on pages 430 to 437

Heckel safety shoes

Performance with style



A brand of the uvex group

Heckel, headquartered in France, has been a specialist in safety footwear since 1970 and is among the pioneers of the industry. Heckel has been part of the uvex group since 2001 and its products are distributed in over 30 countries.

Performance with style

Heckel stands for performance. When wearing Heckel safety shoes, users know they are fully protected and ready for the most extreme conditions. By not compromising on the quality and testing of our products, we guarantee the performance of our safety shoes and the protection of the professionals who wear them. Heckel safety shoes protect against mechanical and chemical risks as well as heat, cold and moisture, while emphasising style.

MACSOLE® technology

Being a true specialist in rubber soles, Heckel has been developing its own technology for more than 20 years: MACSOLE®. Made from an exclusive mixture of nitrile rubbers, MACSOLE® soles offer unrivalled performance in slip resistance, durability and comfort.

MACSOLE® ADVENTURE 3.0

OFF THE
BEATEN TRACK



Resistant and durable
MACSOLE® ADVENTURE 3.0 rubber soles guarantee unrivalled performance in slip resistance and durability and are also resistant to contact heat.



Designed for outdoor use
With a scuffcap made from highly abrasion-resistant rubber and the Agile Ankle Guard support system, these safety shoes are suitable for outdoor work and difficult surfaces.



Comfortable & wear-resistant
The natural elastic properties of rubber combined with innovative MACABSORB technology ensure shock absorption that is 85% higher than the standard for durable wearer comfort.



Safety Footwear



SR

67323



HRO

67313

MACCROSSROAD 3.0 LOW + HIGH S3L FO CI HI HRO SC SR

MACSOLE® ADVENTURE 3.0 rubber **sole** with EVA MACABSORB inserts at the heel and forefoot | liquid-resistant oiled full-grain leather **upper** with Agile Ankle Guard reinforced heel and sides | polyester 3D mesh **lining** | non-metallic **toe cap** | non-metallic **penetration-resistant sole** | **hygienic insole** made from 85% recycled PU foam with shock absorption at the front and heel

Areas of application: heavy application

Removable insole made wholly or partly from recycled materials
Free from harmful substances according to our restricted substances list



	MACCROSSROAD 3.0 LOW	MACCROSSROAD 3.0 HIGH
Art. no. Width 10	67322	67312
Art. no. Width 11	67323	67313
Art. no. Width 12	67324	67314
Standard EN ISO 20345:2011	S3 CI HI HRO SRC	S3 CI HI HRO SRC
Standard EN ISO 20345:2022	S3L FO CI HI HRO SC SR	S3L FO CI HI HRO SC SR
Colours	black, lime	black, lime
Sizes	36 to 48	35 to 51
Weight	650 g	700 g
Order unit	PR	PR

Safety Footwear



67353



67363



67373



MACCROSSROAD 3.0 HIGH META S3L FO CI HI HRO M SC SR + **HIGH BOA** S3L FO CI HI HRO SC SR + **LOW BOA** S3L FO CI HI HRO SC SR

MACSOLE® ADVENTURE 3.0 rubber **sole** with EVA MACABSORB inserts at the heel and forefoot | liquid-resistant oiled full-grain leather **upper** with Agile Ankle Guard reinforced heel and sides | BOA® Fit System easy, quick fastening solution with personalised adjustment (BOA) | D30 100 J energy absorption highly flexible (META) **metatarsal protection** | polyester 3D mesh **lining** | non-metallic **toe cap** | non-metallic **penetration-resistant sole** | **hygienic insole** made from 85% recycled PU foam with shock absorption at the front and heel

Areas of application: heavy application

Removable insole made wholly or partly from recycled materials
Free from harmful substances according to our restricted substances list

	MACCROSSROAD 3.0 HIGH META	MACCROSSROAD 3.0 HIGH BOA	MACCROSSROAD 3.0 LOW BOA
Art. no. Width 10	67352	67362	67372
Art. no. Width 11	67353	67363	67373
Art. no. Width 12	67354	67364	67374
Standard EN ISO 20345:2011	S3 M CI HI HRO SRC	S3 CI HI HRO SRC	S3 CI HI HRO SRC
Standard EN ISO 20345:2022	S3L FO CI HI HRO M SC SR	S3L FO CI HI HRO SC SR	S3L FO CI HI HRO SC SR
Colours	black, lime	black, blue	black, blue
Sizes	36 to 48	36 to 48	36 to 48
Weight	740 g	700 g	670 g
Order unit	PR	PR	PR

Safety Footwear

METAL FREE



67733



67723



FOCUS 2.0 SANDAL + PERFO S1 PL FO SR

double density PU **sole**, excellent levels of grip, shock absorption | ultra-breathable oiled nubuck leather **upper**, large perforations for perfect ventilation, Velcro fastening (SANDAL) | ultra-breathable oiled nubuck perforated leather **upper**, reflective elements, non-metallic eyelets and hooks (PERFO) | 3D polyester mesh **lining** for excellent breathability, quick drying | metal-free **toe cap** | metal-free **penetration-resistant midsole** | anatomically shaped **hygienic insole**, textile top layer and perforations, EVA heel shock absorber

Areas of application: medium applications

Removable insole made wholly or partly from recycled materials.
Free from harmful substances according to our restricted substances list

	FOCUS 2.0 SANDAL	FOCUS 2.0 PERFO
Art. no. Width 11	67733	67723
Standard EN ISO 20345:2011	S1P SRC	S1P SRC
Standard EN ISO 20345:2022	S1 PL FO SR	S1 PL FO SR
Colours	black	black
Sizes	36 to 47	36 to 47
Weight	565 g	575 g
Order unit	PR	PR

Safety Footwear

S3L



67713

FOCUS 2.0 S3 LOW + HIGH S3L FO SR

double density PU **sole**, excellent levels of grip, shock absorption | water-resistant and padded **tongue** with gussets to keep dirt and debris out | water-resistant oiled nubuck leather and textile **upper**, reflective elements, non-metallic eyelets and hooks, padded collar | 3D polyester mesh **lining** for excellent breathability, quick drying | metal-free **toe cap** | metal-free **penetration-resistant midsole** | anatomically shaped **hygienic insole**, textile top layer and perforations, EVA heel shock absorber

Areas of application: medium applications

Removable insole made wholly or partly from recycled materials. Free from harmful substances according to our restricted substances list



67703

	FOCUS 2.0 LOW	FOCUS 2.0 HIGH
Art. no. Width 11	67713	67703
Standard EN ISO 20345:2011	S3 SRC	S3 SRC
Standard EN ISO 20345:2022	S3L FO SR	S3L FO SR
Colours	black	black
Sizes	36 to 47	36 to 47
Weight	570 g	615 g
Order unit	PR	PR

MACSOLE® 1.0 WLD LOW S3 CI HI-1 HRO WG SRC



MACSOLE® 1.0 smooth rubber **sole** | liquid-resistant pigmented full-grain leather **upper** | fire-resistant Kevlar® thread seams, pigmented full-grain leather protective flap, double Velcro® fastening | mesh **lining** | non-metallic **toe cap** | stainless steel **penetration-resistant sole** | **insole** PU insole

Areas of application: welding, steelworking, protection against metal projection

Free from harmful substances according to our restricted substances list



62963

WLD

	MACSOLE® 1.0 WLD LOW
Art. no.	62963
Standard EN ISO 20349-2:2021	S3 CI HI-1 HRO WG SRC
Colours	black
Sizes	38 to 48
Weight	810 g
Order unit	PR



Safety Footwear
Accessories · Inlay soles



94908



95798



95178



95158



95188



95348



86938



94598

clima zone

Replacement insoles

- improved full-surface shock absorption
- ultra-breathable, moisture-absorbing and quick-drying materials
- shock absorption zones support natural movement of the foot
- non-irritating, comfortable surface structure
- antistatic properties
- arch support
- washable, hand wash at 30°C

Accessories - Inlay soles	Insole uvex 1 G2, uvex 1 G2 planet	Insole uvex 1 x-craft, uvex 1 sport, uvex 1 sport white	Insole uvex 1 sport NC, uvex 1 sport white NC	Insole uvex 1 business	Insole uvex 2 trend	Insole uvex 1, uvex 2, uvex 2 construction, uvex 2 xenova®	Insole uvex 3, uvex 3 MACSOLE®	Insole uvex 3 asphaltpro
Art. no. Width 10	94907	95797	95177	95157	95187	95347	86937	94597
Art. no. Width 11	94908	95798	95178	95158	95188	95348	86938	94598
Art. no. Width 12	94909	95799	95179	95159	95189	95349	86939	94599
Art. no. Width 14	94900	95790	-	-	-	95340	-	-
Version	for uvex 1 G2, uvex 1 G2 planet	for uvex 1 x-craft, uvex 1 sport, uvex 1 sport white	for uvex 1 sport NC, uvex 1 sport white NC	for uvex 1 business	for uvex 2 trend	for uvex 1, uvex 2, uvex 2 construction, uvex 2 xenova®	for uvex 3, uvex 3 MACSOLE®	for uvex 3 asphaltpro
Sizes	35 to 52	35 to 52	35 to 52	39 to 52	36 to 52	35 to 52	36 to 52	38 to 50
Order unit	PR	PR	PR	PR	PR	PR	PR	PR

Safety Footwear

Accessories · Inlay soles



LOW

Art. no. 95281
Art. no. 95284
Art. no. 95287
Sizes 35 to 52



MEDIUM

Art. no. 95282
Art. no. 95285
Art. no. 95288
Sizes 35 to 52



HIGH

Art. no. 95283
Art. no. 95286
Art. no. 95289
Sizes 35 to 52



clima zone

uvex tune-up comfortable insole

Antistatic insole concept for use in safety footwear. Designed to increase wearer comfort and enhance ergonomics by providing optimum support for the arches of the feet, helping to reduce foot fatigue.

- three different arch support versions: high, medium, low
- very good cushioning for comfort underfoot
- reduces symptoms of fatigue
- prevents pressure points
- non-irritating, comfortable surface structure
- breathable and absorbs moisture
- anti-bacterial
- antistatic
- suitable for ESD footwear
- hand-washable at 30°C
- certified for use in the following uvex safety shoes



Accessories - Inlay soles	uvex tune-up comfortable insole	uvex tune-up comfortable insole	uvex tune-up comfortable insole
Art. no. arch support low	95281	95284	95287
Art. no. arch support medium	95282	95285	95288
Art. no. arch support high	95283	95286	95289
Version certified in accordance with EN ISO 20345 for the safety shoe types	uvex 1, uvex 2, uvex 2 MACSOLE® uvex 2 xenova®	uvex 1 x-craft, uvex 1 sport	uvex 1 G2
Sizes	35 to 52	35 to 52	35 to 52
Order unit	PR	PR	PR

Safety Footwear

uvex care system



uvex nano shoe add on

footwear waterproofing for protection against moisture penetration and stains

The principle

Water-based uvex nano shoe “add on” waterproofing forms a colourless, invisible film on leather and textile surfaces which protects footwear from moisture penetration and water or oil stains. Although the technological expertise owes its origins to chemical nanotechnology, the product contains no actual nano particles. uvex nano shoe ‘add on’ makes footwear surfaces smooth so, that liquids simply run off. It does not alter the look or breathability of the impregnated material, irrespective of whether this is suede,

leather or textile. Contains no aggressive ingredients which might attack footwear surfaces.

How it works

- Protects from moisture penetration:
The speed at which moisture penetrates leather or textile surfaces which have been treated is significantly reduced. Water and oil simply run off.
- Maintains breathability:
uvex nano shoe ‘add on’ waterproofing does not affect the breathability of footwear surface materials.
- Improves cleaning
Footwear surfaces impregnated with uvex nano shoe ‘add on’ can be more easily cleaned, since water and oil stains cannot penetrate deep into the fabric.
- Long-lasting stain prevention:
Regular applications will significantly reduce repeated staining from water or oil-based liquids.

- No change to the look or feel of the surface:

The look or feel of footwear is not altered by the neutral uvex nano shoe ‘add on’ waterproofing. uvex nano shoe ‘add on’ is free from formaldehyde and phenol and contains no nano particles.

Application

- clean leather and textile surfaces thoroughly beforehand
- shake solution before use, then spray onto material to form a thin film over the surface (avoid drips forming)
- if necessary, wipe over excess liquid with a cloth to spread evenly
- leave to dry at room temperature for at least 12 hours
- repeat treatment as above when needed to maintain the effect

The nano shoe add on working principle

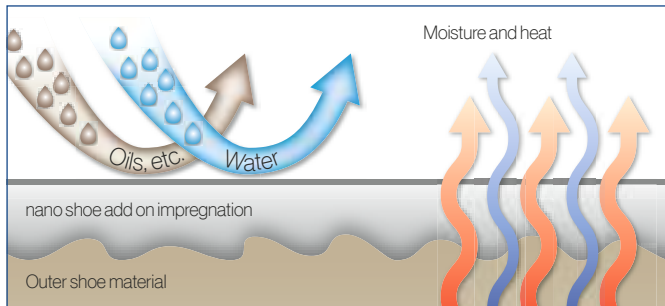

uvex nano shoe add on	
Art. no.	9698100
Content	100 ml
Order unit	PC



uvex nano shoe add in:

footwear disinfectant against foot odour and athlete's foot

The principle

uvex nano shoe ‘add in’ uses specially developed technology which releases controlled doses of active ingredients with long-lasting effect: The uvex nano shoe ‘add in’ disinfectant contains antimicrobial and antifungal active ingredients which eliminate bacteria and fungus over the longer term. Although this expertise owes its origins to chemical nanotechnology, the uvex nano shoe

‘add in’ does not contain any actual nano particles: The formula contains only active ingredients which are approved for use for a number of years and can be found in cosmetics (formaldehyde-free, phenol-free).

How it works

- Odour prevention:
Regular application of uvex nano shoe ‘add in’ in new shoes will prevent any build-up of odour from the outset. Unlike deodorants, which simply cover sweaty smells, this product deals with the underlying causes: bacteria.
- Ongoing deodorization:
Application of uvex nano shoe ‘add in’ will return footwear that has already been well worn to odour-neutral conditions.

- Kills fungi:
Filamentous or yeast fungi are among the most common causes of skin diseases (such as athlete's foot) affecting the feet. uvex nano shoe ‘add in’ kills existing fungi and prevents reoccurrence.

Use

- uvex nano shoe add in is optimised for use in the interior of the shoe. Shake before use. Hold the spray head inside the shoe and spray on approximately five to ten pumps of the uvex nano shoe add in. Only wear shoes that have dried fully. (Allow shoes to dry for at least 15 minutes).

Application

- 1–2 times a week.

The nano shoe add in working principle

Controlled release of germicidal agents to protect against foot odour and athletes foot

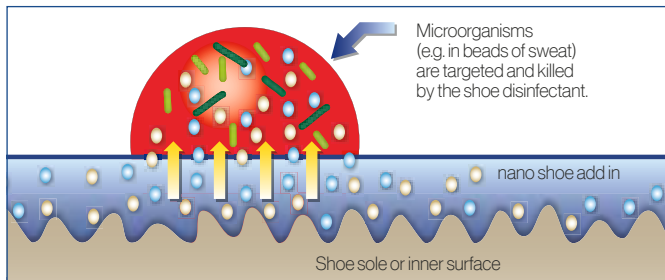

uvex nano shoe add in	
Art. no.	9698300
Content	125 ml
Order unit	PC

Safety Footwear

Polymer boot · Accessories



94756



94766



98754

NORA safety boots S5 SRC

General features:

- long PVC safety boot

Protection features:

- free of plasticisers included on the SVHC Candidate List of the REACH Regulation
- resistant to oil, grease, fuel, alkalis, acids and disinfectants
- with steel toecap and midsole
- toe and heel reinforcements plus ankle protection
- antistatic

Comfort features:

- anatomically shaped lasts, prevent foot fatigue
- leg height 33 cm (for size 42 boot)
- long shaft, can be shortened
- anatomically shaped insole
- pull-off aid

uvex tricot liner socks

- kind to the skin
- extremely high level of moisture absorption
- washable at up to 30 °C
- elastic



NORA safety boots S5 SRC		
Art. no.	94756	94766
Standard EN ISO 20345:2011	S5 SRC	S5 SRC
Standard EN ISO 20345:2022	S5 FO	S5 FO
Upper	PVC	PVC
Sizes	37 to 48	36 to 47
Order unit	PR	PR

uvex tricot liner socks	
Art. no.	98754
Sizes	39/40 to 47/48
Material	70% polyester, 30% wool
Order unit	PR



You can find more information at uvex-academy.com

Industrial protective footwear

This practical seminar will help you to analyse the dangers that employees face, determine what equipment is required to keep them safe and select the most appropriate protective footwear



- basic information on the areas of application of PPE footwear
- information on standards, the differences between primary and secondary requirements and their applications
- description of the labels found on protective footwear and the meaning of the various codes
- identification and assessment of dangers, developing a risk analysis strategy and understanding which safety equipment is necessary
- information on materials, production processes and areas of application including:
 - Upper materials and lining
 - Soles
 - Protective toecaps
 - Penetration-resistant inlay
- choosing the correct protective footwear for each application

Target group

Those responsible for the work-related health and safety of employees, e.g. health and safety officers, specialist purchasers and representatives of employee groups.

For more information or to book a place, please visit uvex-academy.de, call +49 911 9736-1710 or email academy@uvex.de





Individual PPE



The uvex brand is our responsibility

We have been producing and selling high-quality products for the protection of people in sport, leisure and work for **over 90 years**. And if you want to protect people, **you have to take responsibility**.

It is precisely from this mission that our obligation derives to act in a **sustainable, social and socially-responsible** manner.

uvex Individual PPE

Organisational measures:

Durability and waste prevention

Compared to standard products (e.g. over-specs, disposable hearing protection), our custom protective products can be used for much longer. This saves valuable resources and reduces waste and CO₂ emissions over the entire period of use.

uvex hearing protection otoplastics, prescription safety spectacles and prescription VDU spectacles are supplied in reusable cases that can be used throughout their use. We are therefore making an important contribution to the prevention of packaging waste and at the same time we are extending the service life of our products.

Expertise and supply network

Decades of experience and reliable cooperation with our partners form the basis for the production of custom uvex protective products.

Our production partners are subject to regular audits and are obligated to comply with uvex social standards.

All uvex products are manufactured according to the strictest safety standards, regularly inspected, and certified by independent institutes.

uvex hazardous substances list

We do not use harmful ingredients for our individual protective products. The products are produced in accordance with the provisions of the REACH regulation and, in addition, in accordance with the requirements of the uvex banned hazardous substances list.

Durability
of uvex safety spectacles
with prescription approx.

1.5
years of use

uvex hearing
protection otoplastics

100%

nitrogen recovered from the
production process and fed
back into circulation



Packaging of uvex medicare insoles

95%

recycled cardboard

Durability of uvex
hearing protection
otoplastics approx.

5
years of use



SBU Occupational Health

Individual personal protective equipment from uvex

MADE IN UVEX



INDIVIDUAL ADJUSTMENT

Individual personal protective equipment from uvex

The health of your employees is of central importance to us through the uvex vision **protecting people.**

uvex offers individual premium solutions for protecting the eyes, ears and feet – providing maximum safety for your team.

That's because standard solutions are not enough for uvex.

Individual personal protective equipment combines a high level of innovation and individual adjustment to the wearer, making each product unique. All products from the fields of optics, otoplastics and orthopaedics are customised, ensuring that they are tailor-made to the needs of your employees.

Protective equipment that fits your employees perfectly is more likely to be worn – giving your team reliable protection.

Our custom protective products are characterised in particular by their longevity. Compared to standard products (e.g., overspecs, disposable-hearing

protection), they are used for a much longer time, saving us valuable resources and, calculated over the entire period of use, producing much less waste.

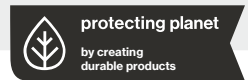

'Made in uvex'

Decades of experience and innovative technologies form the basis for products that are manufactured in accordance with the most stringent safety standards.

Whether it's eye, hearing or foot protection: Our individual personal protective equipment ensures that maximum levels of safety and comfort are provided.

Our innovations set new standards in quality and technology by combining excellent wearing comfort, attractive design and sophisticated functionality.

Our motto 'Made in uvex' guarantees a comprehensive quality system and the best possible processing technology. All materials used are free from harmful substances and are regularly inspected.

uvex places great importance on a sustainable production concept with first-class products and an in-house value creation chain, with a focus on production facilities in Germany and Europe. What's more, uvex offers maximum service with maximum flexibility.

CLAIM TO QUALITY

SBU Occupational Health

Individual personal protective equipment from uvex

Individual eye protection – uvex prescription safety spectacles

- certified prescription safety spectacles in accordance with EN 166 and Regulation (EU) 2016/425 on personal protective equipment
- wide selection of focus types and lens materials to meet all requirements
- the wide range of frames in different designs are available internationally and take into account the diverse head shapes of your employees
- qualified consultation and customisation by uvex specialists



Individual eye protection – uvex VDU spectacles

- VDU spectacles for professional use when working in front of a computer monitor and when no safety spectacles need to be worn
- wide selection of focus types and lens materials to meet all requirements
- qualified consultation and customisation by uvex specialists



Individual hearing protection – uvex high-fit

- certified otoplastic hearing protection in accordance with EN 352
- a wide selection of filters, otoplastic shapes and materials ensures that appropriate otoplastics are available for (virtually) all areas of application
- individual adjustments carried out by qualified specialists



Orthopaedic solutions for uvex safety shoes – uvex medicare

- certified orthopaedic safety footwear in accordance with EN ISO 20345:2011
- e.g. comfortable customised insoles and shoe adjustments
- wide range of usable uvex safety shoes
- uvex motion 3XL for extra-wide feet and medical conditions (e.g. diabetes)
- customisation by orthopaedics specialists



SBU Occupational Health

Individual personal protective equipment from uvex

ONE BRAND.
ONE VISION.
ONE MISSION.



OUR MISSION

#protecting people

The uvex brand mission. This is our objective and our responsibility. uvex protects people – when working, playing sport and pursuing leisure activities.

Decades of experience enable us to transfer expertise continuously between the sectors of industrial safety and top-level sport, and provides the foundation on which we are able to continuously develop our products.

It allows us to create innovations and solutions based on advanced technologies that reliably protect people – whether they are on a production line, on the ski slopes or on a mountain bike.

OUR FUTURE

Sustainable actions and social responsibility

If you rely on uvex, you are guaranteed sustainable actions. From environmental protection to social commitment: uvex puts corporate responsibility at the forefront of its daily business.

The focus of our commitment is to protect people:

- sustainable product concept
- avoidance of the use of hazardous beyond the requirements of the REACH regulation (the uvex banned hazardous substances list)
- uvex social standard for all manufacturing plants
- social commitment (e.g. Rainer Winter Foundation, Vision for the World)

OUR SERVICE

Time and location adapted to your needs

As an experienced specialist in occupational safety, uvex is able to offer an all-round professional service for individual personal protective equipment and meet the specific requirements of your company. Individual PPE products demand a wealth of expertise in the

consultation stage. This is why the adaptation is made by highly qualified experts – such as opticians, audiologists or orthopaedic shoe manufacturers – at a time and location to suit your needs.



Individual PPE:
For more information, visit our website.



uvexsafetygroup



uvexsafetygroup



uvexsafety



uvexsafetygroup



Prescription safety spectacles and prescription VDU spectacles



Product system planet series › Individual PPE

uvex has developed the **protecting planet** icon, to help raise awareness of its commitment to achieving increased sustainability. Based on the brand claim, **protecting people**, our sustainable approach integrates three core interlinked pillars – **ecology, economy** and **social responsibility**, that are incorporated throughout the business to improve our sustainability performance.

This explains the comprehensive audit, measurement and evaluation management process uvex undertakes along the entire value chain to ensure its products are as sustainable as possible.

uvex RX cd 5521 planet

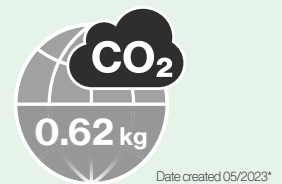

 **protecting planet**
by using bio-based material //
by maximum reduction of pollutants

Material and health protection

- › the frame is mostly made of high-quality, bio-based material
- › instead of crude oil, the base is made of the renewable raw material from the castor plant
- › 38 percent of the frame is based on castor oil
- › castor cultivation does not compete with food-growing areas or endanger forested areas
- › no harmful ingredients
- › produced in accordance with the provisions of the REACH regulation and beyond, according to the specifications of the uvex banned hazardous substances list

38%

of the frame is based on castor oil

Durability approx.

1.5

years of use



Health protection

REACH

regulations are exceeded



protecting planet

by creating durable products

Durability

- › uvex prescription safety spectacles are characterised by their durability
- › the average service life is 1.5 years, which saves valuable resources and reduces CO₂ emissions



protecting planet

by using environmentally-friendly packaging // by reducing waste

Packaging

- › uvex prescription safety spectacles are supplied with a case to extend the service life
- › the case can be reused after its useful life
- › this means we are making an important contribution to the prevention of packaging waste



Prescription safety spectacles

Individual eye protection from uvex

**MADE FOR
YOUR EYES**
MADE IN **UVEX**



uvex prescription safety spectacles are individually adapted to the wearer's vision while offering the best possible protection in the workplace.

The spectacles are certified and marked in accordance with EN 166, so they can be used in workplaces where safety spectacles are mandatory. As occupational safety spectacles, they not only protect the eyes (from UV radiation, flying particles, dust etc.), but are also a visual aid because the lenses have a dioptric effect.

uvex offers a wide range of high-quality lens materials, focus types and frames. This makes it easier to switch between personal spectacles and employer-provided safety spectacles, which increases wearer acceptance.

The comprehensive uvex quality system guarantees the best design from an optical and processing technology perspective. All materials used (lenses, frames, cases etc.) are free from harmful substances and are regularly inspected.

The collection

uvex offers a variety of frames for prescription safety spectacles.

uvex RX bc plastic



- bc: basic collection
- in different shapes, sizes and colours

uvex RX bc metal



- bc: basic collection
- in different shapes, sizes and colours

uvex RX ti



- ti: titan
- made of high-quality titanium
- extremely stable
- lightweight
- allergy-neutral

uvex RX cb



- cb: custom bridge
- Suitable for people with:
- a flat nose bridge
 - high cheekbones
 - wide temples

uvex RX cd



- cd: comfort and design
- safety spectacles in a sporty design

uvex RX sp



- sp: sporty
- safety spectacles in a wrap-around design for anatomic sport lenses

uvex RX cd flip-up



- cd: comfort and design
- for workplaces with special requirements

uvex RX cf



- cf: close fit
- safety spectacles with all-round protection and tailored to your individual prescription
- recommended for handling chemicals and/or working in dusty environments

Prescription safety spectacles

Individual eye protection from uvex

uvex as a partner for individual protective equipment

Our eyesight needs special protection – and many activities in our working lives leave them vulnerable to serious risks. uvex does not compromise on eye protection and offers reliable protection with individually adapted safety spectacles.

Decades of experience and innovative technologies form the basis for uvex products, which are manufactured in accordance with the most stringent safety standards. In addition to safety, uvex also guarantees maximum comfort and quality. Protective equipment that fits properly not only offers reliable protection, but is more likely to be worn by the employee.

Our service – your benefits

uvex offers maximum service with maximum flexibility. Our specialists are happy to advise you with regard to professional and flexible solutions, tailored to the individual requirements of your company.

Our wide uvex collection enables us to find prescription safety spectacles for each of your employees.



uvex experts:

- on-site service from qualified opticians and master opticians
- qualified advisers in uvex customer service
- comprehensive uvex optical service partner network in Germany, Austria and Switzerland, as well as in other European countries



uvex flexibility:

- product consultation and adaptations on request.
- appointments are also possible during the early, late or night shift
- uvex online appointment tool optimises planning



uvex expertise:

- decades of experience in optics and continuous development of products
- training courses/practical seminars for your employees (e.g. company doctors, occupational safety specialists)
- 'Made in uvex' quality: First-class products with an in-house value creation chain and a focus on production facilities in Germany/Europe



digital service tools:

- uvex RX lens consulting for the optimal product selection for your requirements
- uvex centRX, the web-based centring tool for determining the necessary centring parameters to order your individual safety spectacles



www.uvex-safety.com/en/individual-ppe/digital-servicetools/

The easy steps to your prescription safety spectacles

1 Scheduled appointment and consultation

Make an appointment by phone or email and get advice from uvex experts on prescription safety spectacles.

+49 911 97361400

customerservice.sbu-oh@uvex.de

2 Workplace analysis and product search

Our uvex specialists will be happy to present our uvex collection in person at your company and will conduct a workplace analysis with you to find the best products for you and your employees.

3 Finished prescription safety spectacles

After consulting and selecting your personal product, either on-site or at one of the uvex optical service partners, your prescription safety spectacles will be ready for you in a timely manner.

Please contact us for further, non-binding information.



Prescription safety spectacles

uvex international service expertise

UVEX SERVICE NETWORK

Service partners & opticians

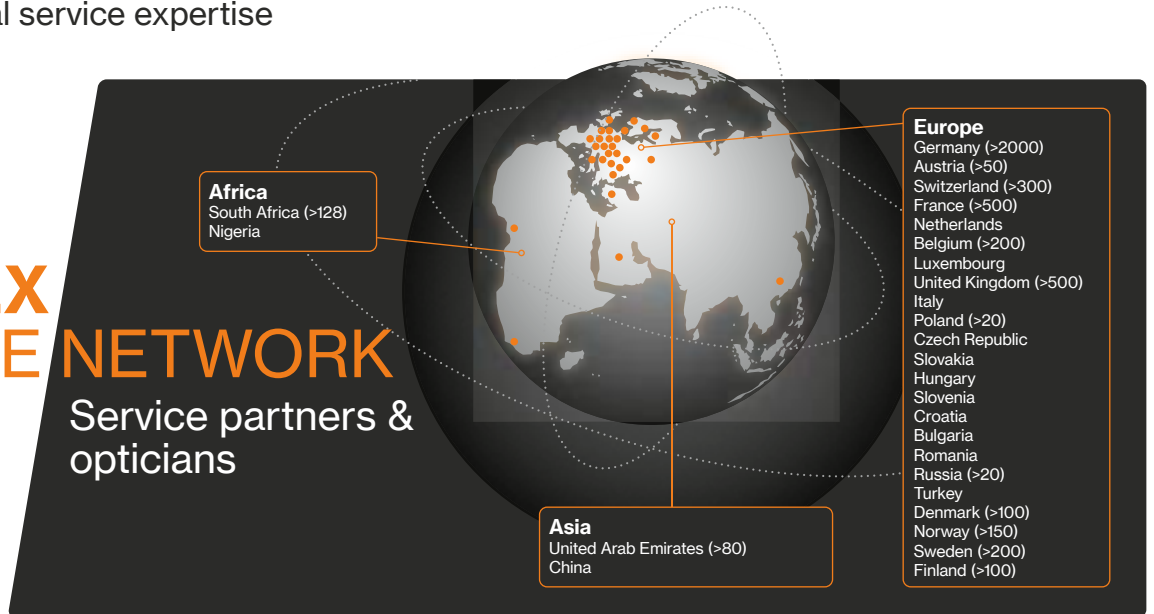

uvex strives to provide you and your employees with uvex prescription safety spectacles, no matter where your company is located. That's why we offer an international uvex network of production facilities and service partners in many countries. This network is continuously being expanded.



Perfect fit around the globe

Many frames can be anatomically adapted to different head shapes to ensure a perfect fit, e.g. for



high cheek bones



flat nose bridge



wide temples

Our uvex RX cb and uvex RX cd collections meet the standard requirements for the field of view and coverage for both the European test head and the Asian test head.



Further information can be obtained via:

- +49 911 9736-1400
- customerservice.sbu-oh@uvex.de

Digital service tools

uvex centRX – uvex RX lens advice

**MADE FOR
YOUR EYES**
MADE IN UVEX



www.uvex-safety.com/en/individual-ppe/digital-servicetools/

Maximum service with maximum flexibility

With our uvex RX lens consulting and uvex centRX digital service tools, we offer useful service tools in the fields of prescription safety spectacles and prescription VDU spectacles, which provide you with valuable information at a glance to facilitate your daily work or the ordering process.



www.uvex-safety.com/en/uvex-rx-lens-consulting/

uvex RX lens consulting

Optimal selection of products – conveniently online

What are the advantages of the different lens types and coatings for innovative uvex prescription safety spectacles? Find the optimum product to meet requirements quickly and easily using the practical uvex RX app.



uvex centRX – customisation – simple, fast, digital

The uvex centRX [pronounced 'sentricks'] photo-centring tool is a web-based, easy-to-use solution for quickly and reliably determining the necessary centring parameters for ordering uvex safety and VDU prescription spectacles. It offers customers, retailers and service partners the opportunity to determine the necessary parameters via a photo and to order glasses digitally using the simple menu navigation. The centring requirements of individual focus groups are stored in the application, so that the possibility of calculation errors in determining the specific height is eliminated.



centrx.uvex-safety.com

Your benefits at a glance:

Determine independent, custom centring parameters for ordering lenses

- ✓ Very simple and digital
- ✓ web-based, no installation required
- ✓ No registration required
- ✓ No data storage
- ✓ Available in German and English

What you need for uvex centRX:

- ✓ PC, laptop or notebook with Internet browser Edge, Chrome or Firefox
- ✓ Ability to shoot photos in .jpg/.jpeg/.png formats
- ✓ An Internet Connection

Start straightaway without registering

Are you interested in uvex centRX? Feel free to add our web address as a favourite in your browser. You can start the application online immediately.



centrx.uvex-safety.com



uvex

Prescription safety spectacles

uvex RX bc plastic frames

Basic collection
uvex RX bc plastic

classic
timeless
virtually unrestricted prescription lenses



6109252



6109253

uvex RX bc 5523

- round plastic frame with metal arms
- transparent side shields
- good fit with anatomically shaped nose bridge and easily adjustable earpieces

uvex RX bc 5523		
Art. no.	6109252	6109253
Ref. no.	5523 1525 49/20	5523 7415 49/20
Lens diameter	49 mm	49 mm
Bridge width	20 mm	20 mm
Colour	grey, translucent	green, grey
Extras	metal arms	metal arms
Marking on frame	W 166 FT CE	W 166 FT CE

Prescription safety spectacles

uvex RX bc plastic frames



6109219
6109203



6109204

uvex RX bc 5503

- plastic frames with classic lens shape
- transparent side shields with integrated brow guard
- good fit with anatomically shaped nose bridge

uvex RX bc 5503			
Art. no.	6109219	6109203	6109204
Ref. no.	5503 1300 50/17	5503 1300 54/17	5503 7415 54/17
Lens diameter	50 mm	54 mm	54 mm
Bridge width	17 mm	17 mm	17 mm
Colour	anthracite	anthracite	green, grey
Extras			metal arms with spring hinges
Marking on frame	W 166 FT CE	W 166 FT CE	W 166 FT CE



6108215



6109210

uvex RX bc 5502

- close-fitting plastic frames
- side shields and integrated brow guard frame design
- specially shaped frames provide protection against particles from below
- good fit with anatomically shaped nose bridge
- individually adjustable side arms with four different lengths and adjustable soft-form comfort ear pieces

uvex RX bc 5502	
Art. no.	6108215
Ref. no.	5502 1725 56/15
Lens diameter	56 mm
Bridge width	15 mm
Colour	grey
Marking on frame	W 166 F CE

uvex RX bc 5506

- comfortable plastic frame
- side shields and integrated brow guard frame design
- good fit with anatomically shaped nose bridge

uvex RX bc 5506	
Art. no.	6109210
Ref. no.	5506 1725 56/18
Lens diameter	56 mm
Bridge width	18 mm
Colour	light grey, translucent
Marking on frame	W 166 F CE



Prescription safety spectacles

uvex RX bc metal frames

Basic collection
uvex RX bc metal

classic
timeless
virtually unrestricted prescription lenses



6109114

uvex RX bc 5109

- modern, rounded metal frame
- transparent side shields
- anatomically adjustable nose pads and ear-pieces ensure an exceptional fit

uvex RX bc 5109

Art. no.	6109114
Ref. no.	5109 6100 50/19
Lens diameter	50 mm
Bridge width	19 mm
Colour	gold
Marking on frame	W 166 FT CE



6109115

uvex RX bc 5110

- classic, square metal frame
- transparent side shields
- anatomically adjustable nose pads and ear-pieces ensure an exceptional fit

uvex RX bc 5110

Art. no.	6109115
Ref. no.	5110 1300 55/17
Lens diameter	55 mm
Bridge width	17 mm
Colour	anthracite
Marking on frame	W 166 FT CE



6109116

uvex RX bc 5111

- large metal frame in a retro design featuring a double bridge
- transparent side shields
- anatomically adjustable nose pads and ear-pieces ensure an exceptional fit

uvex RX bc 5111

Art. no.	6109116
Ref. no.	5111 1800 57/19
Lens diameter	57 mm
Bridge width	19 mm
Colour	silver
Marking on frame	W 166 FT CE

Prescription safety spectacles

uvex RX bc metal frames



6109100
6109101

uvex RX bc 5102

- fashionable, aviator-style metal frame
- transparent side shields
- anatomically adjustable nose bridge and ear-pieces ensure an exceptional fit

uvex RX bc 5102		
Art. no.	6109100	6109101
Ref. no.	5102 1400 51/20	5102 1400 53/20
Lens diameter	51 mm	53 mm
Bridge width	20 mm	20 mm
Colour	gunmetal, matt	gunmetal, matt
Marking on frame	W 166 FT CE	W 166 FT CE



6109104
6109105

uvex RX bc 5103

- classic design metal frame with double bridge
- transparent side shields
- anatomically adjustable nose bridge and ear-pieces ensure an exceptional fit

uvex RX bc 5103		
Art. no.	6109104	6109105
Ref. no.	5103 1400 53/17	5103 1400 55/17
Lens diameter	53 mm	55 mm
Bridge width	17 mm	17 mm
Colour	gunmetal, matt	gunmetal, matt
Marking on frame	W 166 FT CE	W 166 FT CE



6109108
6109109

uvex RX bc 5106

- classic design metal frame
- transparent side shields
- anatomically adjustable nose bridge and ear-pieces ensure an exceptional fit

uvex RX bc 5106		
Art. no.	6109108	6109109
Ref. no.	5106 1400 50/20	5106 1400 52/20
Lens diameter	50 mm	52 mm
Bridge width	20 mm	20 mm
Colour	gunmetal, matt	gunmetal, matt
Marking on frame	W 166 FT CE	W 166 FT CE



6109112
6109113

uvex RX bc 5108

- slim, expressive metal frame
- transparent side shields
- anatomically adjustable nose bridge and ear-pieces ensure an exceptional fit

uvex RX bc 5108		
Art. no.	6109112	6109113
Ref. no.	5108 3400 54/19	5108 3400 56/19
Lens diameter	54 mm	56 mm
Bridge width	19 mm	19 mm
Colour	steel blue	steel blue
Marking on frame	W 166 FT CE	W 166 FT CE



6109103

uvex RX bc 5101

- classic design metal frame with double bridge
- side shields made of wire mesh for good air circulation
- anatomically adjustable nose pads
- arms with sprung hinges and easily adjustable earpieces

uvex RX bc 5101		
Art. no.	6109103	
Ref. no.	5101 1018 56/17	
Lens diameter	56 mm	
Bridge width	17 mm	
Colour	black, silver	
Marking on frame	W 166 FT CE	



uvex

Prescription safety spectacles

uvex RX ti

Titanium collection

uvex RX ti

lightweight
allergy-neutral
corrosion-resistant



6109404

uvex RX ti 5904

- thin, lightweight titanium frame
- transparent side shields
- lightweight, allergy-neutral and corrosion-resistant
- anatomically adjustable nose pads and ear-pieces ensure an exceptional fit

uvex RX ti 5904

Art. no.	6109404
Ref. no.	5904 1900 52/19
Lens	52 mm
Bridge width	19 mm
Colour	silver, matt
Marking on frame	W 166 FT CE



6109405

uvex RX ti 5905

- large titanium frame in a retro design featuring a double bridge
- transparent side shields
- lightweight, allergy-neutral and corrosion-resistant
- anatomically adjustable nose pads and ear-pieces ensure an exceptional fit

uvex RX ti 5905

Art. no.	6109405
Ref. no.	5905 1900 57/19
Lens	57 mm
Bridge width	19 mm
Colour	silver, matt
Marking on frame	W 166 FT CE

Prescription safety spectacles

uvex RX cb



custom bridge
uvex RX cb

perfect fit for
high cheekbones
wide temples
flat nose bridge



6109232

uvex RX cb 5580

- wide fitting plastic frame for the best fit
- frame design with side shields and integrated brow guard
- easily adjustable, soft-form ear pieces for extra comfort
- ideal for individuals with a flat nose bridge, high cheekbones and/or wide temples.
- tested for use with Asian headform 2M, DIS ISO 18526-4:2018

uvex RX cb 5580	
Art. no.	6109232
Ref. no.	5580 3015 57/14
Lens	57 mm
Bridge width	14 mm
Colour	dark blue, grey
Marking on frame	W 166 F CE



6109233

uvex RX cb 5581













- plastic frame with extra wide temple width
- frame design with side shields and integrated brow guard
- easily adjustable, soft-form ear pieces for extra comfort
- ideal for individuals with a flat nose bridge, high cheekbones and/or wide temples.
- tested for use with Asian headform 2M, DIS ISO 18526-4:2018

uvex RX cb 5581	
Art. no.	6109233
Ref. no.	5581 1542 58/14
Lens	58 mm
Bridge width	14 mm
Colour	grey, dark red
Marking on frame	W 166 F CE



Prescription safety spectacles

Lens options uvex RX bc for plastic and metal frames · uvex RX ti · uvex RX cb

Focus type		Lens type	Parameter for centering of the lenses
Description			Specific height Box measure
Single vision			
<ul style="list-style-type: none"> - Correction of visual defect in far, in-between or near distance 		Single vision, Single vision HD	Single vision HD ≥ centre of lens Main line of sight
Certified prescription range			
Comfort lenses			
Nahcomfort - Version with expanded near vision - Ideal for workplace environments of 30 cm to approx. 2 m Distanzcomfort - Calculation of the individual correction for defined distances (1 m, 2 m or 4 m) Single vision Relax - To accommodate the prescription for the lower part of the lens, the prescription is increased by +0.5 of a diopter	  	Nahcomfort Standard, Nahcomfort Optima Versions see page 398 Distanzcomfort Optima Single vision Relax	min. 17 mm Main line of sight min. 17 mm Zero line of sight min. 15 mm Zero line of sight
Certified prescription range			
Bifocal and bifocal comfort			
<ul style="list-style-type: none"> - Correction of visual defect in far and reading distance - Visible segment for near distance - Steplike change from far distance to near distance at the edge of segment - Bifocal: Instantly well-tolerated, visible edge of segment supports orientation >> For bifocal comfort, see page 399	Bifocal  Bifocal Comfort 	Width of segment: 28 mm, curved	
Certified prescription range		Bifocal comfort (CR 39 and PC only) +4.5 to -10.0 dpt. at maximum value cyl. +/- 6.0 dpt. Add. +3.0	
Varifocals			
<ul style="list-style-type: none"> - Correction of visual defect in far, in-between and near distance - Gliding change from far distance to near distance (progressive canal) - The non-visible gliding zone corrects in-between distances 	    Varifocal Optima, Optima HD  Varifocal OR 	Varifocal Standard - Standard area for far distance and near distance - Long, narrow canal of progression Varifocal Pro Work - Large area for far distance - Wide canal of progression - Optimized area for reading distance Varifocal Piccolo - Suitable for flat frames - Large area for far distance and near distance - Shortened canal of progression Varifocal Top One - Very comfortable, large long-distance and close-up field of vision - Wide canal of progression for added convenience - Minimal blur in peripheral vision	min. 23 mm Zero line of sight min. 20 mm Zero line of sight min. 17 mm Zero line of sight min. 19 mm Zero line of sight
Certified prescription range		Varifocal OR (CR 39 and PC only) +4.5 to -10.0 dpt. at maximum value cyl. +/- 6.0 dpt. Add. +3.0	Optima and varifocal OR min. 17 mm Optima HD min. 16 mm (depending on the corridor length) Zero line of sight

- ▶ The overview shows the maximum prescription range which is approved and certified. Depending on the size of the frame and the lens material, further restrictions may apply.
- ▶ Please take into account the specifications relating to the line of sight when determining the vision point.

	Material						Extras, optional				
	CR 39	HI 1.6	Plastic HI 1.67	PC	Trivex	Silicate Hard glass	Normal AR	Super AR	UV blue protect	Tint	Variomatic brown
	■	■	■	■	■	HD not available	■	■	■	■	■
		incl. hard coating only available with SAR recommended from +/- 4.0 dpt.	incl. hard coating only available with SAR recommended from +/- 6.0 dpt.	incl. hard coating	incl. hard coating		only single vision	■	only HI 1.67 or PC		only Polycarbonate or Trivex
	+10.0 to -10.0 dpt. at maximum value cyl. ± 8.0 dpt.	+12.0 to -13.0 dpt. at maximum value cyl. ± 8.0 dpt.	+13.0 to -14.5 dpt. at maximum value cyl. ± 8.0 dpt.	+9.5 to -12.0 dpt. at maximum value cyl. ± 8.0 dpt.	+8.0 to -11.0 dpt. at maximum value cyl. ± 7.0 dpt.	+7.0 to -6.0 dpt. at maximum value cyl. ± 4.0 dpt.					+7.5 to -8.5 dpt. at maximum value cyl. ± 6.0 dpt.
	Standard/ Optima	only Optima	only Optima	Standard/ Optima	only Optima	—	■	■	only HI 1.67 or PC	—	—
	■	■	■	■	■	—	■	■	only HI 1.67 or PC	—	—
	■	■	■	■	■	—	■	■	only HI 1.67 or PC	—	—
	+9.0 to -7.5 dpt. at maximum value cyl. ± 6.0 dpt.	+8.0 to -8.0 dpt. at maximum value cyl. ± 6.0 dpt.	+9.0 to -10.0 dpt. at maximum value cyl. ± 6.0 dpt.	+9.0 to -6.0 dpt. at maximum value cyl. ± 6.0 dpt.	+7.0 to -6.0 dpt. at maximum value cyl. ± 4.0 dpt.						
	■	Bifocal only	—	■	—	Bifocal only	■	■	—	■	—
	+7.0 to -8.0 dpt. at maximum value cyl. ± 6.0 dpt. Add. +3.0	+8.5 to -10.5 dpt. at maximum value cyl. ± 8.0 dpt. Add. +3.0		+10.0 to -10.0 dpt. at maximum value cyl. ± 6.0 dpt. Add. +3.0		+6.0 to -6.0 dpt. at maximum value cyl. ± 4.0 dpt. Add. +3.0					
	■	■	■	■	—	■	■	■	—	■	only Polycarbonate
	■	■	■	■	■	■	■	■	only HI 1.67 or PC	■	only Polycarbonate or Trivex
	■	■	■	■	—	—	■	■	—	■	only Polycarbonate
	■	■	■	■	—	■	■	■	only HI 1.67 or PC	■	only Polycarbonate
	■	only Optima and Optima HD	only Optima and Optima HD	■	only Optima and Optima HD	—	only Optima	■	only HI 1.67 or PC	■	only Polycarbonate or Trivex
	+6.0 to -10.0 dpt. at maximum value cyl. ± 6.0 dpt. Add. +3.0	+9.5 to -12.0 dpt. at maximum value cyl. ± 6.0 dpt. Add. +3.0	+10.0 to -12.0 dpt. at maximum value cyl. ± 6.0 dpt. Add. +3.0	+9.5 to -10.0 dpt. at maximum value cyl. ± 6.0 dpt. Add. +3.0	+6.0 to -13.0 dpt. at maximum value cyl. ± 6.0 dpt. Add. +3.0	+6.0 to -6.0 dpt. at maximum value cyl. ± 4.0 dpt. Add. +3.0					+7.5 to -10.0 dpt. at maximum value cyl. ± 6.0 dpt. Add. +3.0



uvex

Prescription safety spectacles

uvex RX cd



comfort and design
uvex RX cd

modern
sporty
protective functions integrated into
frame design



6109249*



Reflective uvex logo

uvex RX cd 5521

- stylish plastic frame with reflective uvex logo
- transparent lens frame for an unrestricted field of view
- good fit thanks to anatomically shaped nose bridge
- sporty arms made from a combination of soft and hard components to ensure increased comfort and non-slip fit

uvex RX cd 5521	
Art. no.	6109249*
Ref. no.	5521 1813 54/22
Lens diameter	54 mm
Bridge width	22 mm
Colour	silver, anthracite
Marking on frame	W 166 F CE



6109254



6109255

uvex RX cd 5524 planet

- modern, close-fitting plastic frame
- the frame is primarily made of high-quality, bio-based material. Instead of crude oil, this material is based on the renewable raw material of the castor plant
- the total percentage of the castor oil base for the frame is 38%
- translucent frame colour for an unobstructed field of vision
- frame design with integrated side shields and upper eye coverage
- soft, adjustable nose bridge
- easily adjustable soft-form comfort ear-pieces

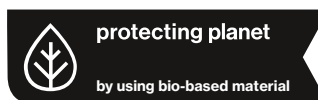

uvex RX cd 5524 planet		
Art. no.	6109254*	6109255*
Ref. no.	5524 2513 53/16	5524 2513 57/16
Lens diameter	53 mm	57 mm
Bridge width	16 mm	16 mm
Colour	translucent, anthracite	translucent, anthracite
Marking on frame	W 166 F CE	W 166 F CE

Prescription safety spectacles

uvex RX cd 5521 planet



Date created 05/2023*

38%

is the total percentage of the castor oil base for the frame



The renewable raw material from the castor plant forms the base

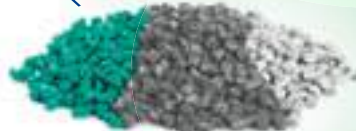

High-quality, bio-based polyamides conserve resources

SUSTAINABLE MODERN SAFE



6109257

Excellent wearer comfort
› easy-to-adjust, soft ear-pieces

Always visible
› reflective uvex logo

Unrestricted field of vision
› transparent lens frame

Sporty design
› increased wearer acceptance

protecting planet
by using bio-based material // by maximum reduction of pollutants

- › the frame is mostly made of high-quality, bio-based material
- › instead of crude oil, the base is the renewable raw material from the castor plant
- › 38% of the frame is based on castor oil
- › castor cultivation does not compete with food-growing areas or endanger forested areas
- › no harmful ingredients
- › produced in accordance with the provisions of the REACH regulation and beyond, according to the specifications of the uvex banned hazardous substances list

protecting planet
by creating durable products

- › uvex prescription safety spectacles are characterised by their durability
- › the average service life is 1.5 years, which saves valuable resources and reduces CO₂ emissions

protecting planet
by using durable packaging // by reducing waste

- › uvex prescription safety spectacles are supplied with a case to extend the service life
- › the case can be reused after its useful life
- › this means we are making an important contribution to the prevention of packaging waste

uvex RX cd 5521 planet

For the uvex RX cd 5521 planet frame, the same criteria for comfort and functionality apply as for the uvex RX cd 5521 (see left page).

► Please note the lens options for uvex RX cd on pages 388/389.

uvex RX cd 5521 planet	
Art. no.	6109257
Ref. no.	5521 1369 54/22
Lens diameter	54 mm
Bridge width	22 mm
Colour	anthracite, jade
Marking on frame	W 166 F CE



Prescription safety spectacles

uvex RX cd



6109225*



6109226*

uvex RX cd 5514

- close-fitting plastic frame
- transparent side shields and integrated brow guard frame design
- soft, adjustable nose bridge
- easily adjustable soft-form comfort ear pieces

uvex RX cd 5514		
Art. no.	6109225*	6109226*
Ref. no.	5514 1033 53/18	5514 1045 55/18
Lens diameter	53 mm	55 mm
Bridge width	18 mm	18 mm
Colour	black, blue	black, red
Marking on frame	W 166 F CE	W 166 F CE

► Please note the glazing options for uvex RX cd on pages 388/389.



6109236*

uvex RX cd 5520

- contemporary plastic frame in stylish colours
- good fit thanks to anatomically shaped nose bridge
- translucent lens frame for an unobstructed field of view
- uvex Comfort Sliders allow the side arm length and inclination to be adjusted for a customised fit
- the spectacles can also be worn without uvex Comfort Sliders
- completely metal-free

uvex RX cd 5520	
Art. no.	6109236*
Ref. no.	5520 1333 54/18
Lens diameter	54 mm
Bridge width	18 mm
Colour	anthracite, blue
Marking on frame	W 166 F CE

► Please note the glazing options for uvex RX cd on pages 388/389.



Accessories for uvex x-fit pro non-prescription safety spectacles are compatible with uvex RX cd 5520 and can be purchased from the uvex online shop.
<https://www.uvex-safety-shop.de/home>

uvex Comfort Slider
Art. no. 9958024
Order unit 1 PC
Contents 5 pairs

uvex mini LED light
Art. no. 9999100
Order unit 1 PC

uvex x-fit pro headband
Art. no. 9958023
Order quantity multiples 5 PC

Prescription safety spectacles

uvex RX cd 5522

uvex RX cd 5522 tight-fit-kit

FLEXIBLE / ROBUST / SAFE

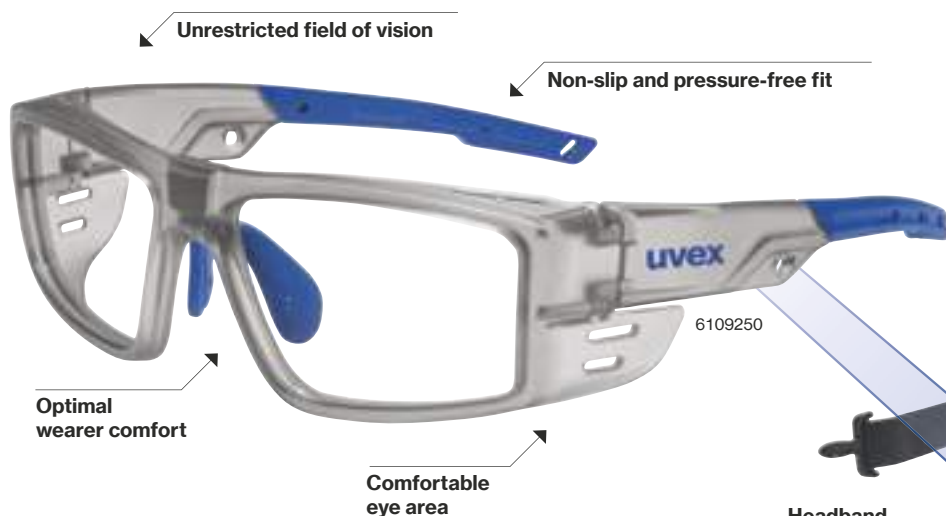

uvex RX cd 5522

- modern plastic frame in a robust design
- translucent frame colour for an unobstructed field of vision
- air vents at the top and side
- soft, adjustable nose bridge
- sporty arms made from a combination of soft and hard components to ensure increased comfort and non-slip fit
- soft, adjustable ear-pieces with metal core

Headband
› easy fitting –
for a more secure fit

Accessories for extra protection against liquids

uvex RX cd 5522 tight-fit-kit

- set consisting of seal and headband
- seal made of hard and soft components provides a tight fit
- protection against liquids (droplets) – marking 3, in accordance with EN 166
- headband for a more secure fit, can be fitted straight onto the side arms



Seal
› simply clip into the upper and side air vents of the frame to close them and fix the seal

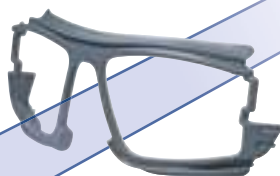

6118012



uvex RX cd 5522 (6109250) with uvex RX cd 5522 tight-fit-kit (6118012)

	uvex RX cd 5522	uvex RX cd 5522 tight-fit-kit
Art. no.	6109250	6118012
Ref. no.	5522 2533 58/15	
Lens diameter	58 mm	
Bridge width	15 mm	
Colour	translucent-grey, blue	black, anthracite
Marking on frame	Frame: W 166 F CE	Face seal: W 166 3F CE
Compatible with	6118012	6109250
Order unit		PC

► Please note the glazing options for uvex RX cd on pages 388/389.



Prescription safety spectacles

uvex RX cd



6109234*



6109230*



6109231*

uvex RX cd 5518

- sporty frame design: attractive and durable
- metal-free
- comfortable soft arms (uvex duo component technology), non-slip fit without pressure points
- good fit thanks to anatomically shaped nose bridge

uvex RX cd 5518			
Art. no.	6109230*	6109231*	6109234*
Ref. no.	5518 1341 54/22	5518 5074 54/22	5518 1333 54/22
Lens diameter	54 mm	54 mm	54 mm
Bridge width	22 mm	22 mm	22 mm
Colour	anthracite, red	dark brown, green	anthracite, blue
Marking on frame	W 166 F CE	W 166 F CE	W 166 F CE

► Please note the glazing options for uvex RX cd on pages 388/389.



6109208
6109209



6118000
6118001



uvex RX cd 5505 with uvex RX cd seal

uvex RX cd 5505

- close-fitting plastic frames
- integrated side shields and brow guard for an exceptionally close fit
- specially shaped frames provide protection against particles from below
- good fit with anatomically shaped nose bridge
- individually adjustable side arm length and angle for a customised fit and adjustable soft-form comfort ear pieces

uvex RX cd 5505		
Art. no.	6109208	6109209
Ref. no.	5505 2900 55/19	5505 2900 57/19
Lens diameter	55 mm	57 mm
Bridge width	19 mm	19 mm
Colour	transparent	transparent
Marking on frame	W 166 F CE	W 166 F CE

uvex RX cd 5505 seal

- foam seal frame for uvex RX cd 5505 for use when working with dust, chips or fluids
- complies with EN 166 "Protection against liquid droplets and splashes" (category "3")

uvex RX cd 5505 seal		
Art. no.	6118000	6118001
Ref. no.	5505 seal 55/19	5505 seal 57/19
Lens diameter	55 mm	57 mm
Bridge width	19 mm	19 mm
Colour	black	black
Order unit	PC	PC
seal marking	W 166 3 F CE	W 166 3 F CE

► Please note the glazing options for uvex RX cd on pages 388/389.

Prescription safety spectacles

uvex RX cd flip-up



comfort and design
uvex RX cd flip-up

for special applications
flip-up with non-prescription special
lenses



6109218
6109235



6109237
6109238



6109247
6109248

uvex RX cd 5505 flip-up welding protection

- flip-up with welding protection lenses, non-prescription
- level of protection 5 (welding), suitable for autogenous welding
- filter technology with grey-tinted lenses provides reliable protection against UV and infrared radiation as well as ensuring perfect colour recognition
- **Note:** welding protection lenses do not provide sufficient protection against laser beams!
- level of protection 5 in accordance with EN 169 (welding), mech. strength F in accordance with EN 166

uvex RX cd 5505 flip-up, didymium

- flip-up incl. non-prescription didymium lenses
- didymium lenses are special filters with a high absorption rate of 589 nm
- they filter bright yellow sodium flare
- lightweight polycarbonate filter with high mechanical strength
- level of protection 2-2 in accordance with EN 170, mech. strength F
- **Note:** Didymium lenses do not provide increased protection against infrared radiation (IR)

RX cd 5505 flip-up Didymium plan PC SAR

- plastic frame with flip-up for users who do not require a prescription
- main frame including non-prescription polycarbonate lenses with super anti-reflective coating
- flip-up including non-prescription didymium lenses to filter bright yellow sodium flare (589 nm)

uvex RX cd 5505 flip-up welding protection		
Art. no.	6109218	6109235
Ref. no.	5505 9905 55/19	5505 9905 57/19
Lens	55 mm	57 mm
Bridge width	19 mm	19 mm
Colour	black, green	black, green
Features: flip-up		
Lens	PC grey, welding protection 5	PC grey, welding protection 5
	uvex infradur plus	uvex infradur plus
Lens marking	5 W1 FTK CE	5 W1 FTK CE
Marking on frame	W 166 F CE	W 166 F CE









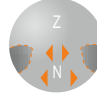
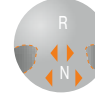

uvex RX cd 5505 flip-up, didymium		
Art. no.	6109237	6109238
Ref. no.	5505 9910 55/19	5505 9910 57/19
Lens diameter	55 mm	57 mm
Bridge width	19 mm	19 mm
Colour	crystal matt, green	crystal matt, green
Features: flip-up		
Lenses	violet PC, didymium	violet PC, didymium
Lens marking	2-2 W 1 F CE	2-2 W 1 F CE
Marking on frame	W 166 F CE	W 166 F CE

uvex RX cd 5505 flip-up Didymium plan PC SAR		
Art. no.	6109247	6109248
Ref. no.	5505 9051 55/19	5505 9051 57/19
Lens diameter	55 mm	57 mm
Bridge width	19 mm	19 mm
Colour	crystal matt, green	crystal matt, green
Main frame lens	PC transparent, SET	PC transparent, SET
Lens marking	W 1 FT CE	W 1 FT CE
Features: flip-up		
Lenses	violet PC, didymium	violet PC, didymium
Lens marking	2-2 W 1 F CE	2-2 W 1 F CE
Marking on frame	W 166 F CE	W 166 F CE

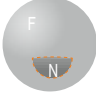

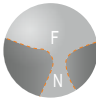
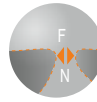
Prescription safety spectacles

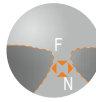
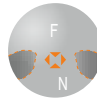
Lens options for uvex RX cd · uvex RX cf 5500 - uvex RX cf 5501

		Lens type	Parameter for centering of the lenses
Description			Specific height Box measure
Single vision			
		Single vision, Single vision HD	Single vision HD min. centre of lens Main line of sight
Prescription range			
Comfort lenses			
 Nahcomfort Standard	 Nahcomfort Optima	 Distanzcomfort Optima	 Single vision Relax
		Nahcomfort Standard, Nahcomfort Optima Versions see page 398	min. 17 mm Main line of sight
		Distanzcomfort Optima	min. 17 mm Zero line of sight
		Single vision Relax	min. 15 mm Zero line of sight
Prescription range			
Bifocals			
 Bifocal		 Bifocal Comfort	Width of segment: 28 mm, curved
Prescription range		Bifocal Comfort (CR 39 and PC only) +4,5 bis -6,0 dpt. at maximum value cyl. +/- 6,0 dpt. Add. +3,0	
Varifocals			
 Varifocal Standard	 Varifocal Pro Work	 Varifocal Piccolo	 Varifocal Top One
		 Varifocal Optima Varifocal Optima HD	 Varifocal OR
		Varifocal Standard	min. 23 mm Zero line of sight
		Varifocal Pro Work	min. 20 mm Zero line of sight
		Varifocal Piccolo	min. 17 mm Zero line of sight
		Varifocal Top One	min. 19 mm Zero line of sight
		Varifocal Optima	min. 17 mm Zero line of sight
		Varifocal Optima HD	min. 16 mm (depending on the corridor length) Zero line of sight
		Varifocal OR	min. 17 mm Zero line of sight
Prescription range		Varifocal OR (CR 39 and PC only) +4,5 bis -6,0 dpt. at maximum value cyl. +/- 6,0 dpt. Add. +3,0	

► In order to ensure optimum vision, uvex compensate the values in accordance to the frame wrap angle (FWA).
 The overview below provides information on the lens options for uvex RX cd frames.
 Please also ensure the frame fits correctly.

► Please take into account the specifications relating to the line of sight when determining the vision point.

	Material					Extras, optional				
	CR 39	HI 1.6	HI 1.67	PC	Trivex	Normal AR	Super AR	UV blue protect	Tinting	Variomatic brown
	■	■	■	■	■	■	■	■	■	■
		incl. hard coating only available with SAR	incl. hard coating only available with SAR	incl. hard coating	incl. hard coating	only single vision		only HI 1.67 or PC		only Polycarbonate or Trivex
	+6.0 to -6.0 dpt. at maximum value cyl. ±4.0 dpt.	+6.0 to -6.0 dpt. at maximum value cyl. ±4.0 dpt.	+6.0 to -6.0 dpt. at maximum value cyl. ±4.0 dpt.	+6.0 to -6.0 dpt. at maximum value cyl. ±4.0 dpt.	+6.0 to -6.0 dpt. at maximum value cyl. ±4.0 dpt.					+6.0 to -6.0 dpt. at maximum value cyl. ±4.0 dpt.
	Standard/Optima	only Optima	only Optima	Standard/Optima	only Optima	■	■	only Optima, HI 1.67 or PC	—	—
	■	■	■	■	■	■	■	only HI 1.67 or PC	—	—
	■	■	■	■	■	■	■	only HI 1.67 or PC	—	only Polycarbonate
	+6.0 to -6.0 dpt. at maximum value cyl. ±4.0 dpt.	+6.0 to -6.0 dpt. at maximum value cyl. ±4.0 dpt.	+6.0 to -6.0 dpt. at maximum value cyl. ±4.0 dpt.	+6.0 to -6.0 dpt. at maximum value cyl. ±4.0 dpt.	+6.0 to -6.0 dpt. at maximum value cyl. ±4.0 dpt.					
	■	Bifocal only	—	■	—	■	■	—	■	—
	+6.0 to -6.0 dpt. at maximum value cyl. ±4.0 dpt.	+6.0 to -6.0 dpt. at maximum value cyl. ±4.0 dpt.		+6.0 to -6.0 dpt. at maximum value cyl. ±4.0 dpt.						
	■	■	■	■	—	■	■	—	■	only Polycarbonate
	■	■	■	■	■	■	■	only, HI 1.67 or PC	■	only Polycarbonate or Trivex
	■	■	■	■	—	■	■	—	■	only Polycarbonate
	■	■	■	■	—	■	■	only, HI 1.67 or PC	■	only Polycarbonate
	■	■	■	■	■	■	■	only, HI 1.67 or PC	■	only Polycarbonate or Trivex
	■	■	■	■	■	only Optima	■	only, HI 1.67 or PC	■	only Polycarbonate or Trivex
	■	—	—	■	—	■	■	—	■	—
	+6.0 to -6.0 dpt. at maximum value cyl. ±4.0 dpt.	+6.0 to -6.0 dpt. at maximum value cyl. ±4.0 dpt.	+6.0 to -6.0 dpt. at maximum value cyl. ±4.0 dpt.	+6.0 to -6.0 dpt. at maximum value cyl. ±4.0 dpt.	+6.0 to -6.0 dpt. at maximum value cyl. ±4.0 dpt.					+6.0 to -6.0 dpt. at maximum value cyl. ±4.0 dpt.



Prescription safety spectacles

uvex RX sp

sporty
uvex RX sp

dynamic
wrap-around design
protective functions integrated
in frame design



uvex anatomic sport lens

- we only use lenses with a base curve that is identical to the curvature of the frame.
- prescription values are recalculated based on the angle of the lenses and taken into account during the glazing process.

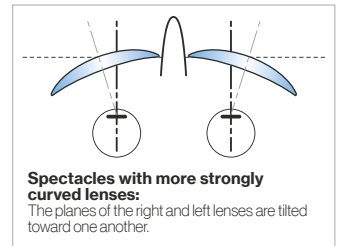
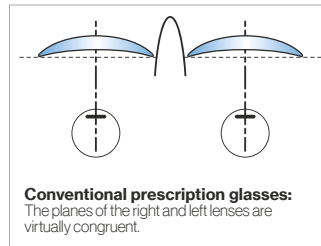

uvex RX sp 5513 planet · uvex RX sp 5513

- The uvex RX sp planet frame is primarily made of high-quality, bio-based material. Instead of crude oil, this material is based on the renewable raw material of the castor plant. The total percentage of the castor oil base is 38%.
- sporty, plastic “wraparound” design with curved lenses and anatomic sport glazing
- side shield and integrated brow guard frame design
- good fit with anatomically shaped soft nose bridge
- sporty arms with a combination of soft and hard components ensure increased comfort and non-slip fit

	uvex RX sp 5513 planet	uvex RX sp 5513
Art. no.	6109256	6109222
Ref. no.	5513 1369 62/16	5513 1577 62/16
Lens diameter	62 mm	62 mm
Bridge width	16 mm	16 mm
Colour	anthracite, jade	grey, light green
Marking on frame	W 166 F CE	W 166 F CE

► Please note the glazing options for uvex RX sp on pages 394/395.

Prescription safety spectacles

uvex RX sp



6109216



6109217

uvex RX sp 5510

- sporty, plastic “wraparound” design with curved lenses and anatomic sport glazing
- side shield and integrated brow guard frame design
- good fit with anatomically shaped soft nose bridge
- sporty arms with a combination of soft and hard components ensure increased comfort and non-slip fit

uvex RX sp 5510		
Art. no.	6109216	6109217
Ref. no.	5510 1217 62/17	5510 1248 62/17
Lens diameter	62 mm	62 mm
Bridge width	17 mm	17 mm
Colour	matt black, light grey	matt black, orange
Marking on frame	W 166 F CE	W 166 F CE

► Please note the glazing options for uvex RX sp on pages 394/395.



6109220



6109221

uvex RX sp 5512

- sporty, plastic “wraparound” design with curved lenses and anatomic sport glazing
- uvex tight-fit-kit consisting of headband and foam material available
- side shield and integrated brow guard frame design
- the arms can be replaced with a headband for a more secure fit when working in extreme conditions
- the foam material guarantees a close and firm fit.
- very good fit with anatomically adjustable, soft nose bridge
- sporty side arms with a combination of soft and hard components ensure increased comfort and non-slip fit

Applications in combination with the tight-fit-kit:

- working in extreme situations, such as overhead or in confined spaces
- working with fluids (drops) or chips and dust
- complies with EN 166 “Protection against liquid droplets and splashes” (category “3”)

uvex RX sp 5512		
Art. no.	6109220	6109221
Ref. no.	5512 5573 65/16	5512 1348 65/16
Lens diameter	65 mm	65 mm
Bridge width	16 mm	16 mm
Colour	brown, olive	anthracite, orange
Marking on frame	W 166 F CE	W 166 F CE

uvex RX sp 5512 tight-fit-kit		
Art. no.	6118004	6118005
Colour	brown, olive	anthracite, orange
Order unit	PC	PC
tight-fit-kit marking	W 166 3 F CE	W 166 3 F CE

► Please note the glazing options for uvex RX sp on pages 394/395.



6118004



6109220 assembled with uvex RX sp 5512 tight-fit-kit 6118004



6118005



6109221 assembled with uvex RX sp 5512 tight-fit-kit 6118005



uvex RX cf 9501

goggle with direct prescription lenses

close fit uvex RX cf

- close-fitting
- all-round protection
- direct glazing
- solutions using RX insert



Recommended use/glazing

Lens material: PC*

- Workplaces with a high risk of mechanical hazards
- such as metal-cutting shaping, turning, grinding and milling
- Mechanical strength "B", 120 m/s

Lens material: Trivex

- Workplaces with a high risk of chemical hazards
- such as laboratories and those handling small quantities of chemicals
- Mechanical strength "F", 45 m/s

uvex RX cf 9501

- goggles with custom prescription
- direct prescription lenses provide exceptional optical quality without aberrations or loss of light
- comfortable TPE frame, stays comfy even when worn for longer periods
- high level of mechanical strength ("B", 120 m/s)
- meets the requirements for additional markings 3 (liquids, droplets) and 4 (coarse dust)

uvex RX cf 9501	
Art. no.	6109501
Ref. no.	9501 1333 61/14
Lens diameter	61 mm
Bridge width	14 mm
Colour	anthracite, blue
Marking on frame	W 166 34 B CE

► Please note the glazing options for uvex RX cf 9501 on pages 394/395.



Direct prescription lenses

Prescription safety lenses are inserted directly into the goggle frame according to the individual prescription strength.



Sophisticated ventilation

Direct and indirect air vents ensure optimum protection and excellent ventilation for "eye zone" comfort.



Flexible headband clip

The flexible headband clip allows the goggle to adjust to different facial shapes for a customised fit. The comfortable fabric headband keeps the uvex RX cf 9501 securely in place.

For further information on lens materials and models, information can be found on pages 396 - 402.

Prescription safety spectacles

uvex RX cf



6108200

uvex RX cf 5500

- spectacles with all-round protection
- fixed RX insert for your individual prescription
- meets the requirements for additional markings 3 (liquids, droplets) and 4 (coarse dust)
- perfect fit providing reliable protection: The side arms can be adjusted to a variety of different lengths, allowing the glasses to be adapted to suit all facial shapes
- flexible soft components adapt to the wearer's face contours

uvex RX cf 5500	
Art. no.	6108200
RX insert lens diameter	48 mm
RX insert bridge width	20 mm
Colour	blue, grey
Marking on frame	W 166 34 F CE
Lenses	PC clear
Lens marking	2C-1,2 W 1 FKN

► Please note the glazing options for uvex RX cd on pages 388/389.



6108201

uvex RX cf 5501

- small goggles with fixed RX insert to suit your individual prescription
- meets the requirements for additional markings 3 (liquids, droplets) and 4 (coarse dust)
- highly compatible with other PPE
- low-volume frame design
- indirect ventilation



















uvex RX cf 5501	
Art. no.	6108201
RX insert lens diameter	48 mm
RX insert bridge width	20 mm
Colour	black, grey
Marking on frame	W 166 34 B CE
Lenses	PC clear
Lens marking	2C-1,2 W 1 FKN

► Please note the glazing options for uvex RX cd on pages 388/389.



Prescription safety spectacles

Lens options for uvex RX sp models · Special lenses for uvex RX cf 9501

uvex RX sp 5510		Important note	Lens type	Parameter for centering of the lenses	
Description				Specific height Box measure	
	Single vision 	for uvex RX sp 5510: Minimum PD ≥ 32.0 mm Fitting height ≥ centre of lens	Single vision Single vision HD	Main line of sight	
	Comfort lenses    Nahcomfort Optima Distanzcomfort Optima Single vision Relax	for uvex RX sp 5510: Minimum PD ≥ 32.0 mm Fitting height ≥ centre of lens	Nahcomfort Optima Distanzcomfort Optima Single vision Relax	min. 17 mm Main line of sight min. 17 mm Zero line of sight min. 15 mm Zero line of sight	
	Varifocals   Varifocal Pro Work Varifocal Optima Varifocal Optima HD	for uvex RX sp 5510: Minimum PD ≥ 32.0 mm Fitting height ≥ centre of lens	Varifocal Pro Work Varifocal Optima Varifocal Optima HD	min. 20 mm Zero line of sight min. 17 mm Zero line of sight min. 16 mm Zero line of sight	
	Prescription range				
	uvex RX sp 5512 · uvex RX sp 5513				
	 	Single vision 	Minimum PD ≥ 32.0 mm Fitting height ≥ centre of lens	Single vision Single vision HD	Main line of sight
		Comfort lenses    Nahcomfort Optima Distanzcomfort Optima Single vision Relax	Minimum PD ≥ 32.0 mm Fitting height ≥ centre of lens	Nahcomfort Optima Distanzcomfort Optima Single vision Relax	min. 17 mm Main line of sight min. 17 mm Zero line of sight min. 15 mm Zero line of sight
		Varifocals   Varifocal Pro Work Varifocal Optima Varifocal Optima HD	Minimum PD ≥ 32.0 mm Fitting height ≥ centre of lens	Varifocal Pro Work Varifocal Optima Varifocal Optima HD	min. 20 mm Zero line of sight min. 17 mm Zero line of sight min. 16 mm Zero line of sight
		Prescription range			
		uvex RX cf 9501			
	Description			Parameter for centering of the lenses Specific height Box measure	
	Single vision 	When using PC or PC+ Minimum PD ≥ 32.0 mm When using Trivex Minimum PD ≥ 34.0 mm	Single vision Single vision HD	Main line of sight	
	Varifocals   Varifocal Pro Work Varifocal Optima Varifocal Optima HD	When using PC or PC+ Minimum PD ≥ 32.0 mm When using Trivex Minimum PD ≥ 34.0 mm	Varifocal Pro Work Varifocal Optima Varifocal Optima HD	min. 20 mm Zero line of sight min. 17 mm Zero line of sight min. 16 mm Zero line of sight	
	Prescription range				

- In order to ensure optimum vision, uvex only uses the special uvex anatomic sport glazing. The overview below provides information on the lens options for uvex RX sp frames and uvex RX goggle. Please also ensure the frame fits correctly.
- Please take into account the specifications relating to the line of sight when determining the vision point.

Material						Extras, optional				
CR 39	HI 1.6	Plastic HI 1.67	PC	Trivex	Normal AR	Super AR	UV blue protect	Tint	Variomatic brown	
■	■	■	■	■	■	■	■	■	■	
	incl. hard coating only available with SAR	incl. hard coating only available with SAR	incl. hard coating	incl. hard coating			only HI 1.67 or PC		only Polycarbonate or Trivex	
■	■	■	■	—	■	■	only HI 1.67 or PC	—	—	
■	■	■	■	—	■	■	only HI 1.67 or PC	—	—	
■	■	■	■	—	■	■	only HI 1.67 or PC	—	—	
■	■	■	■	■	■	■	only HI 1.67 or PC	■	only Polycarbonate or Trivex	
■	■	■	■	■	■	■	only HI 1.67 or PC	■	only Polycarbonate or Trivex	
■	■	■	■	■	■	■	only HI 1.67 or PC	■	only Polycarbonate or Trivex	
+ 5.0 to - 5.0 dpt. at maximum value cyl. ±2.0 dpt.	+ 5.0 to - 5.0 dpt. at maximum value cyl. ±2.0 dpt.	+ 5.0 to - 5.0 dpt. at maximum value cyl. ±2.0 dpt.	+ 5.0 to - 5.0 dpt. at maximum value cyl. ±2.0 dpt.	+ 5.0 to - 5.0 dpt. at maximum value cyl. ±2.0 dpt.					+ 5.0 to - 5.0 dpt. at maximum value cyl. ±2.0 dpt.	
■	■	■	■	■	■	■	■	■	■	
	incl. hard coating	incl. hard coating only available with SAR	incl. hard coating	incl. hard coating			only HI 1.67 or PC		only Polycarbonate or Trivex	
■	■	■	■	—	■	■	only HI 1.67 or PC	—	—	
■	■	■	■	—	■	■	only HI 1.67 or PC	—	—	
■	■	■	■	—	■	■	only HI 1.67 or PC	—	—	
■	■	■	■	■	■	■	only HI 1.67 or PC	■	only Polycarbonate or Trivex	
■	■	■	■	■	■	■	only HI 1.67 or PC	■	only Polycarbonate or Trivex	
■	■	■	■	■	■	■	only HI 1.67 or PC	■	only Polycarbonate or Trivex	
+ 3.5 to - 3.5 dpt. at maximum value cyl. ±2.0 dpt.	+ 3.5 to - 3.5 dpt. at maximum value cyl. ±2.0 dpt.	+ 3.5 to - 3.5 dpt. at maximum value cyl. ±2.0 dpt.	+ 3.5 to - 3.5 dpt. at maximum value cyl. ±2.0 dpt.	+ 3.5 to - 3.5 dpt. at maximum value cyl. ±2.0 dpt.					+ 3.5 to - 3.5 dpt. at maximum value cyl. ±2.0 dpt.	
Material						Extras, optional				
CR 39	HI 1.6	Plastic HI 1.67	PC/PC ⁺	Trivex	Normal AR	Super AR	UV blue protect	Tint	Variomatic brown	
—	—	—	■	■	■	■	■	■	■	
	incl. hard coating only available with SAR	incl. hard coating only available with SAR	incl. hard coating	incl. hard coating			only HI 1.67 or PC		only Polycarbonate or Trivex	
—	—	—	■	■	■	■	only HI 1.67 or PC	■	only Polycarbonate or Trivex	
—	—	—	■	■	■	■	only HI 1.67 or PC	■	only Polycarbonate or Trivex	
—	—	—	■	■	■	■	only HI 1.67 or PC	■	only Polycarbonate or Trivex	
			+ 3.5 to - 3.5 dpt. at maximum value cyl. ±2.0 dpt.	+ 3.5 to - 3.5 dpt. at maximum value cyl. ±2.0 dpt.					+ 3.5 to - 3.5 dpt. at maximum value cyl. ±2.0 dpt.	



Prescription safety spectacles

Certification and marking

Certification

Individually manufactured uvex prescription safety spectacles are tested and certified by independent testing institutes at regular intervals according to the requirements of EN 166.



Marking of lenses in accordance with EN 166

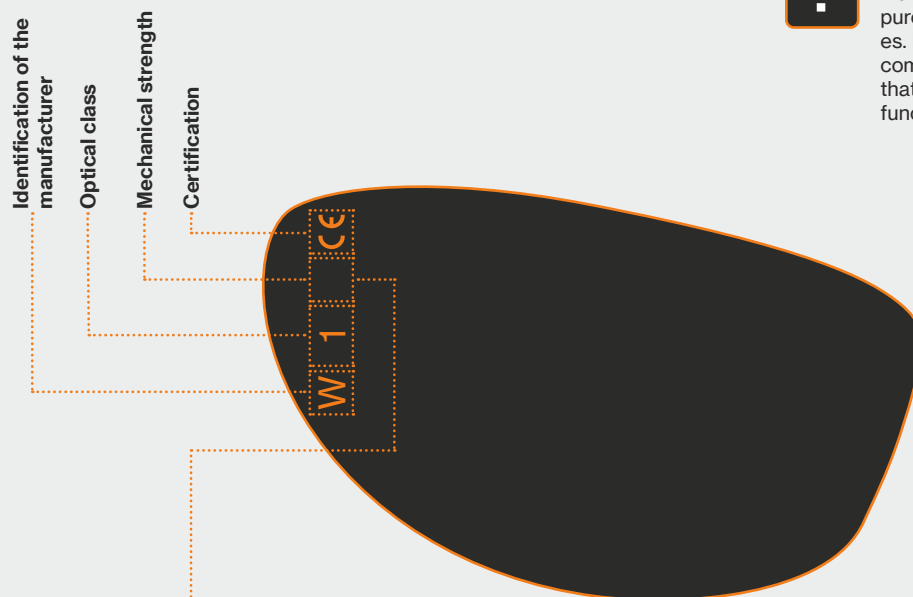

Note: Due to the mandatory marking, it is not possible to purchase frames without lenses. Please do not modify the completed spectacles in a way that reduces their protective function.

- S** **Increased robustness:** Ball bearing drop test, Dropping a ball bearing (44 g) against the lens from a height of 1.30 m
- F** **Impact-resistant, low energy:** Firing a ball bearing (0.88 g) against the lens, impact speed 45 m/s (±162 km/h)
- B** **Impact-resistant, medium energy:** Firing a ball bearing (0.88 g) against the lens, impact speed 120 m/s (±432 km/h)
- T** Optional requirements in accordance with EN 166 (extract): **Tested in extreme temperatures (-5°C, +55°C)**, this marking is always in combination with mechanical strength (for example, FT)

Prescription safety spectacles

Certification and marking

Marking

- frame and lenses are permanently marked
- if the markings on the lens and frame are different, the lower mechanical strength applies to the entire eye protection device
- according to the PPE regulation, uvex prescription safety spectacles must be marked with the factory symbol and production date: ☐ MM/YYYY



Marking in accordance with EN 166 on the lens and inside of the frame

Marking of the frame in accordance with EN 166

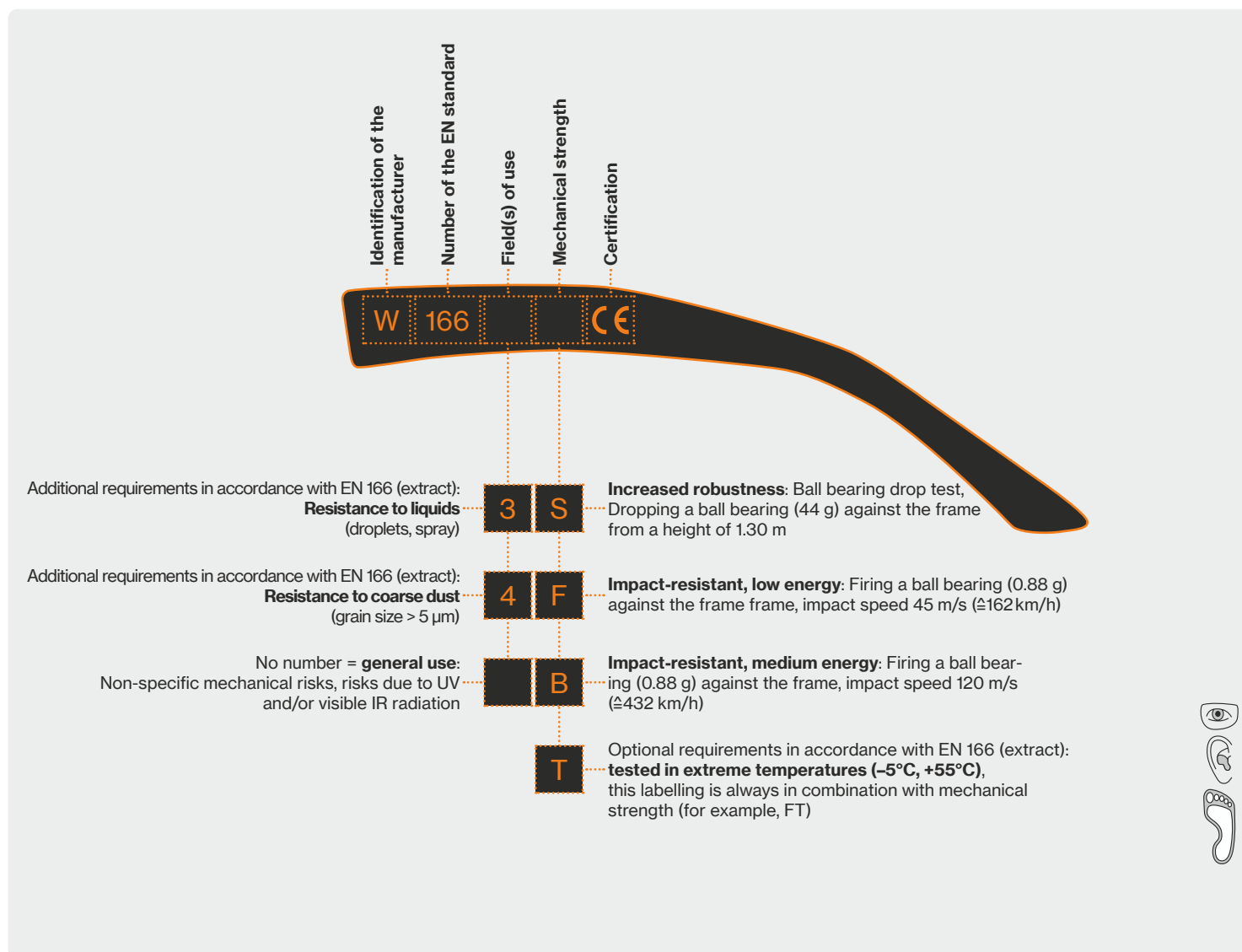

Prescription safety spectacles

Focus types

Single vision lenses

Single vision

- defective vision caused by long-sightedness or short-sightedness is corrected

Single vision HD – the ultimate in customisation!

- free-form single-vision lens
- individual parameters such as cornea vertex distance, frame wrap angle and inclination are taken into account for production purposes.
- calculation of dioptres to an accuracy of one hundredth



Comfort lenses

- ideal for use at workstations with monitors
- comfort lenses relieve the eye when looking at objects close up and at intermediate distances thanks to their seamless correction areas
- comfort lenses are a good alternative if the prescription safety eyewear is only needed at workstations and distance vision (> 5 m distance) is not necessary.



Nahcomfort Standard, Nahcomfort Optima

- perfect solution for working distances between 30 cm and approx. 2 m
- the medium range of the lens surface is determined by the degression chosen and is designed for a distance of approx. 60 cm to 80 cm
- three versions are available, depending on the required reading addition (optional based on the age of the wearer)
- all that is needed to place an order are details of the close-range values and the required design (type A, B, C)
- when ordering the Nahcomfort Optima option, the inner surface of the raw lenses is calculated and manufactured, taking into account the correction, the glass curve and the distance between the eyes

Type A	Type B	Type C
Degression** 0.75 dpt	Degression** 1.25 dpt	Degression** 1.75 dpt
Addition < 1.5 dpt.	Addition 1.5 to 2.25 dpt.	Addition > 2.25 dpt.
< 50 years	50 to 55 years	> 55 years

** Degression: Correction reduced, based on the close-range value!

Note:

Ideal for use in VDU spectacles. About 60% of degression is active at the centring cross, so the recommended adjustment applies on the main line of sight.

Distanzcomfort Optima

- perfect solution for working distances between 30 cm and around 1 m, 2 m or 4 m
- by specifying the viewing distance that is required at the workstation, the correction areas will be calculated individually
- all that is needed to place an order are details of the distance and close-range values (addition), the maximum viewing distance (one, two or four meters) as well as the centering parameters (pupillary distance and specific height)
- recommended adjustment: zero line of sight, distance values and addition

Single Vision Relax

- this type of lens is targeted at people over the age of 30
- an invisibly integrated change to the correction value of +0.5 dpt. in the lower area of the lens eases the strain on the eye when looking at near distances (accommodation support)
- the distance correction remains unchanged
- all that is needed to place an order the details of distance values and centring parameters (pupillary distance and specific height)
- we recommend Single Vision Relax lenses for professionals who use mobile devices (notebook, tablet, smartphone etc.) for their daily work

Prescription safety spectacles

Focus types



Bifocal lenses

Bifocal

- visibly ground segment for near vision ('reading field')
- instant wearer acceptance as visible edge helps eyes to adjust
- intermediate ranges are not corrected



Bifocal Comfort

- free-form bifocal lens with a rounded, blended near-vision area for a more aesthetic appearance
- instant wearer acceptance due to soft transition to the near-vision area
- handled in the same way as conventional bifocal lenses
- intermediate ranges are not corrected



Varifocal lenses

- gradual transition from distance to near vision, known as the progression zone
- the invisible progression zone also corrects intermediate distances
- clear vision at all viewing distances
- may require an initial adjustment phase

Varifocal Optima HD – the ultimate in customisation!

- free-form varifocal lens taking into account individual parameters such as cornea vertex distance, frame wrap angle and inclination
- calculation of dioptres to an accuracy of one hundredth

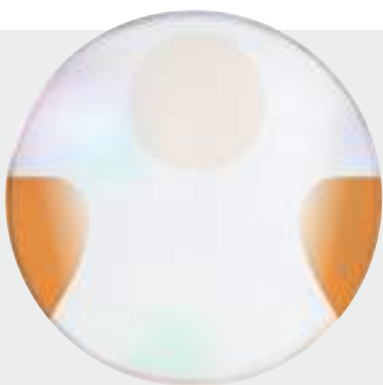

Varifocal OR

- free-form varifocal lens with a blended near-vision area in the upper section to make overhead work easier
- selection of the addition in the upper near-vision area (depending on the working distance)
- the addition in the upper near-vision segment depends on the addition in the progressive part of the lens
- the following can be selected:
 - type A: addition distribution: 100% bottom and 100% top
 - type B: addition distribution: 100% in the progressive near-vision area and 60% in the blended near-vision area
- type B example: addition: bottom 2.0 dpt. /top 1.2 dpt.



Prescription safety spectacles

Lens material



Polycarbonate

- mechanical strength 'F' (45 m/sec)
- organic material with very high breaking strength
- only partially chemical-resistant
- PC⁺ – polycarbonate with increased centre thickness and mechanical strength 'B' (120 m/sec), especially for the uvex RX goggle
- PC and PC⁺: Identification code: 2C-1.2 as per EN 170

Trivex™

- mechanical strength 'F' (45 m/sec)
- best all-round lens material
- excellent resistance to cleaning agents, oils and cosmetics and good scratch resistance
- lightweight, suitable for even higher prescription values

CR39, modified (plastic)

- mechanical strength 'S' (ball drop test)
- lightweight organic material suitable for chemicals and painting
- good scratch resistance due to hard coating (optional)

HI (high index)

Organic lenses with high refractive index – 1.6 or 1.67

- mechanical strength 'S' (ball drop test)
- organic material suitable for chemicals and painting
- the lens is thinner and more aesthetically pleasing

HI 1.6 recommended for a prescription > +/-4.0 dpt.
HI 1.67 recommended for a prescription > +/-6.0 dpt.

Hard glass, modified

(crown glass, silicate, mineral glass, glass)

- mechanical strength 'S' (ball drop test)
- highly scratch-resistant surface suitable for working with chemicals and paints
- heavy, not recommended for prescription values greater than +/-4.0 dpt.
- spark penetration when welding or grinding

UV blue protect

A special absorber has been added to the lens material that completely filters out UV rays and reduces the blue light content.

- the lenses absorb UV radiation up to 400 nm at 100%, filter short-wave blue light until 410 nm almost completely and reduce the range from 410 nm to 420 nm around 86%.
- uvex UV blue protect lenses enhance contrast and effectively prevent signs of fatigue and age-related macular degeneration (AMD)
- UV blue protect is optionally available for polycarbonate (PC) lenses and HI 1.67

- the mechanical strength of the lenses is guaranteed – clear lenses with UV blue protect are marked 2C-1.2 according to EN 170

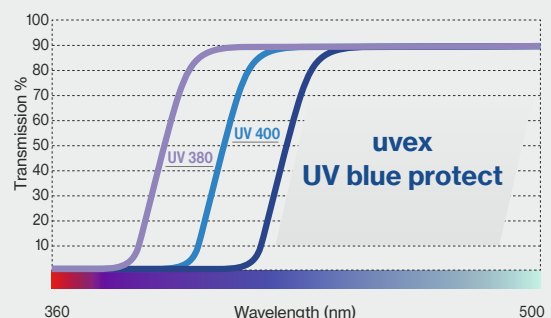

Prescription safety spectacles

Finishes

Anti-reflective coating

Anti-reflective coating is applied to the inside and outside of lenses by means of vapour deposition. It significantly reduces reflections on the surfaces. It offers a cosmetic advantage and increases light transmission.

Three qualities are available:

- normal anti-reflective coating
- super anti-reflective coating

Normal anti-reflective coating	Super anti-reflective coating
Good reflection reduction	Maximum reflection reduction
Metal oxide is applied once to each surface	Metal oxide is applied several times to each surface
Residual reflection \approx 4%	Residual reflection $<$ 2%

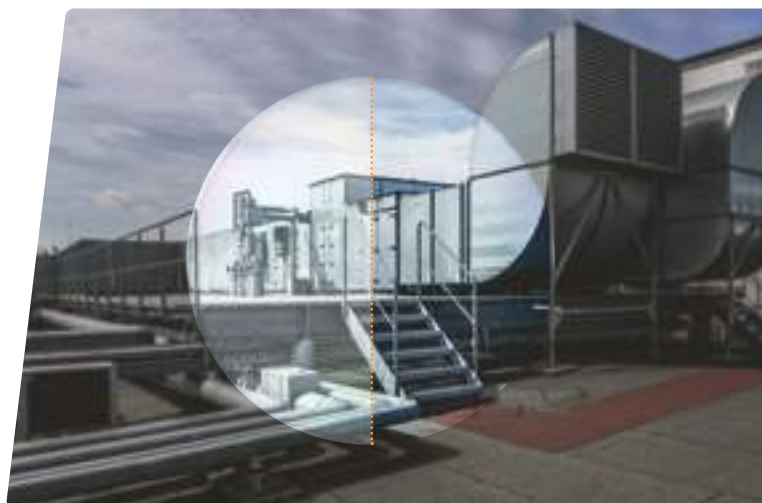

Scratch-resistant coating

To guarantee an ideal surface hardness, all our plastic lenses are given a hard coating (optional for CR 39).



Tint

Tinted lenses provide effective protection against glare in areas with high light intensity (for example, sunlight)

Constant tinting

- available in brown and grey
- tinting levels: 15%, 25%, 65%, 75%

Variable tinting – Variomatic™

- lenses tint automatically depending on the UV radiation and temperature
- tinting of between approx. 8% and 80%, in brown
- available as prescription safety spectacles in polycarbonate and Trivex™

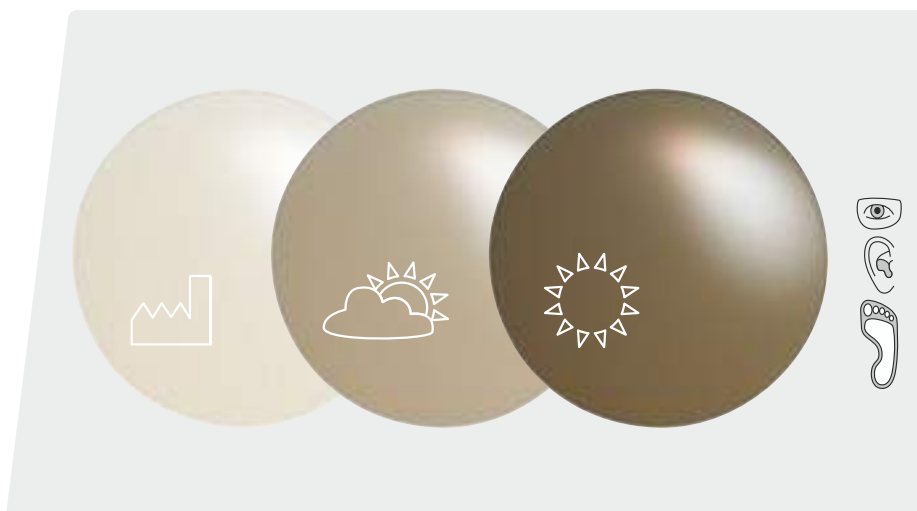

Prescription safety spectacles

Special lenses



Special lenses for special requirements are available in combination with our RX cd 5505 flip-up models. The flip-up is fitted with non-prescription special lenses. The main frame is fitted with individual prescription safety lenses.

Didymium

- special filter with high absorption at 589 nm, resulting in characteristic violet colour
- the 'bright yellow sodium flare' is filtered out
- lightweight polycarbonate filter with mechanical strength 'F' (45 m/s)
- level of protection 2-2 in accordance with EN 170
- marking: 2-2 W 1 F CE
- note: Didymium lenses do not provide increased protection against infrared radiation (IR)

Areas of application:

Glass production, glass processing, e.g. glass blowing

Welding protection

- welding protection level 5 in accordance with EN 169
- grey-tinted polycarbonate filters for reliable protection against UV and infrared radiation with mechanical strength 'F' (45 m/s)
- perfect colour perception during the welding process
- marking: 5 W 1 FTK CE
- note: Welding protection lenses do not provide sufficient protection against laser beams!

Areas of application:

Autogenous welding

uvex i-3 add

Perfect vision in every situation

Optimum protective eyewear means improved, safe vision.

uvex i-3 add safety spectacles have invisible integrated dioptr correction for near vision. Strain on the eyes is effectively reduced (e.g. when reading) and the patented lens technology ensures an instant high level of compatibility for wearers. At the same time, the uvex i-3 add spectacles provide secure protection and optimal comfort.



Variable side arm inclination

The 5-position side arm inclination allows individual adjustment and optimum coverage of the eyes.



Addition

Two models are available for individualised correction of near vision. (+1.0 dpt. and +2.0 dpt.)



Flexible nose loops

The extremely soft adjustable Softflex nose loops ensure a secure fit and can be individually adapted to sit comfortably on the nose.

uvex supervision excellence

The uvex supervision excellence coating guarantees extreme scratch resistance on the outside and permanent anti-fogging properties on the inside.

MADE IN GERMANY 

Patent no.: DE 10 2012 207 384

Perfection in every detail

The patented lens technology makes it possible to integrate two progression zones for near vision on the inside of the duospherical single lens safety spectacles. The correction strength at the bottom of the lenses is +1.0 or +2.0, depending on the model. A distinctive feature and unique selling point is that the patented manufacturing technology means the front area and consequently the base curve of the lenses are not altered.

This combines extremely good coverage and fit, all the way to the edge, together with the benefits of a progressive lens on the inside area. A further benefit is that the progressive zone is not visible and that these spectacles comply with all standards of EN norms that are relevant to safety.

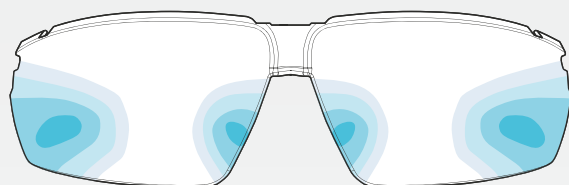

optical lens designed by
optiswiss
original since 1937

Progression zones

This diagram of the lenses shows the large zone that does not feature any optical correction. The transparent, integrated optical correction starts in the region of the middle and the strength increases gradually towards the lower edge of the lenses. The correction strength of the spectacles is +1.0 or +2.0, depending on the model. The free-form lens is manufactured in accordance with standard parameters and designed for a distance of approximately 64 mm between the eyes. These safety spectacles do not permanently replace prescription safety spectacles.

uvex i-3 add

	uvex i-3 add 1.0	uvex i-3 add 2.0
Art. no.	6108210	6108211
Frame	anthracite, lime W 166 FT CE	anthracite, lime W 166 FT CE
Lens	PC clear UV 400 2C-1.2 W 1 FTKN CE	PC clear UV 400 2C-1.2 W 1 FTKN CE
Strength	uvex supervision excellence 1.0 dpt.	uvex supervision excellence 2.0 dpt.
Order unit	PC	PC



Including soft spectacles case with microfibre cloth



VDU spectacles

Individual eye protection at the screen

**MADE FOR
YOUR EYES**
MADE IN **UVEX**



uvex VDU spectacles are specially designed for working at a screen, enabling problem-free vision at a computer workstation.

The special feature of VDU spectacles is the distance for which they have been optimised. Normally, the lens is designed for a viewing distance of approximately 30 cm (reading distance) to correct presbyopia. A screen is usually about 50 cm – 80 cm away from the human eye.

To be able to focus continuously at different distances, spectacle wearers are forced to adopt an unnatural head position and body posture. This can lead to a variety of posture-related symptoms, such as overexertion of the

shoulder and neck muscles, fatigue symptoms or headaches. For most people who wear reading glasses or varifocals in their everyday lives, VDU spectacles are recommended if the main activity in their job requires viewing a computer screen and safety spectacles are not mandatory in the workplace.

uvex offers different lens materials, focus types and frames for VDU spectacles. The 'Made in uvex' quality system guarantees the best design from an optical and processing technology perspective. All materials used are free from harmful substances and are regularly inspected.

The collection

uvex offers different frames for VDU spectacles. Numerous models are available as metal, plastic or titanium frames.

Metal frames



Plastic frames



Titanium frames



VDU spectacles

Individual eye protection at the screen

uvex as a partner for individual VDU spectacles

The position of the screen, keyboard and documents in offices is a special visual requirement. uvex offers individual solutions in the area of VDU spectacles. Decades of experience and innovative technologies form the basis for the uvex products, which are manufactured according to the

highest production standards. In addition to symptom-free vision at work, uvex also guarantees maximum comfort and quality. Employees will be happy to wear those VDU spectacles which fit perfectly and provide reliable support.

Our service – your benefits

uvex offers maximum service with maximum flexibility. Our specialists are happy to advise you with regard to professional and flexible solutions, tailored to the individual requirements of your company.

Our wide uvex collection enables us to find VDU spectacles for each of your employees.



www.uvex-safety.com/en/individual-ppe/digital-servicetools/



uvex experts:

- on-site service from qualified opticians and master opticians
- qualified advisers in uvex customer service
- comprehensive uvex optical service partner network in Germany, Austria and Switzerland, as well as in other European countries



uvex flexibility:

- product consultation and adaptations on request.
- appointments are also possible during the early, late or night shift
- uvex online appointment tool optimises planning



uvex expertise:

- decades of experience in optics and continuous development of products
- training courses/practical seminars for your employees (e.g. company doctors, occupational safety specialists)
- 'Made in uvex' quality: First-class products with an in-house value creation chain and a focus on production facilities in Germany/Europe



digital service tools:

- uvex RX lens consulting for the optimal product selection for your requirements
- uvex centRX, the web-based centring tool for determining the necessary centring parameters for your custom prescription VDU spectacles order

The easy steps to your VDU spectacles

1 Scheduled appointment and consultation

Make an appointment by phone or email and get advice from uvex experts on the topic of VDU spectacles.

+49 911 97361400

customerservice.sbu-oh@uvex.de

2 Workplace analysis and product search

Our uvex specialists will be happy to present our uvex collection to you in person at your company, and will carry out a workplace analysis with you in order to find the optimal products for you and your employees.

3 Finished VDU spectacles

After consulting and selecting your personal product, either on-site or at one of the uvex optical service partners, the VDU spectacles will be ready for you in a timely manner.

Please contact us for further, non-binding information.



VDU spectacles

Focus types

Posture-related symptoms? The solution – uvex Nahcomfort lenses

Avoid posture-related symptoms with VDU spectacles that are individually adjusted to the wearer. Nahcomfort lenses are specially designed to suit computer-based workplaces and provide unrestricted vision at VDU workstations. The advantages are seamless, sharp vision from 30 cm to approx. 2 m. A clear view of keyboard, screen and documents with an ideal head position. This results in a marked reduction in posture-related symptoms, because the head and neck remain in a natural position.



Nahcomfort



- the wearer's usual reading prescription is found in the lower part of the lens.
- the prescription value gradually becomes weaker further up the lens (degression, in the upper part of the lens, vision is clear at a maximum distance of approx. 2 m). The transitions between the different zones are smooth, similar to varifocal lenses.
- all that is needed to place an order are details of the close-range values and the required design (type A, B, C).
- it is necessary to measure the specific height on the basis of the main line of sight. A minimum fitting height of 17 mm in the frame must be observed.

Type A	Type B	Type C
Degression** 0.75 dpt	Degression** 1.25 dpt	Degression** 1.75 dpt
Addition < 1.5 dpt.	Addition 1.75 to 2.25 dpt.	Addition > 2.25 dpt.
< 50 years	50 to 55 years	> 55 years

VDU spectacles

Finishes

uvex UV blue

- surface finish consisting of different layers. It includes a layer that filters short-wave visible light in the blue-violet range with increased effect.
- effective protection against the symptoms of fatigue and headaches associated predominantly with long periods of working at a monitor and/or with digital media.
- the uvex UV blue layer system also includes a super anti-reflection coating, a scratch-resistant coating and an easy-care layer.



Tint

Tinted lenses provide effective protection against glare in areas with high light intensity (for example, sunlight)

Constant tinting

- available in brown and grey
- tinting levels: 15%, 25%, 65%, 75%

Variable tinting – Variomatic™

- lenses tint automatically, depending on the UV radiation and temperature
- tinting of between approx. 8% and 80% in brown or grey
- available with lens material CR 39

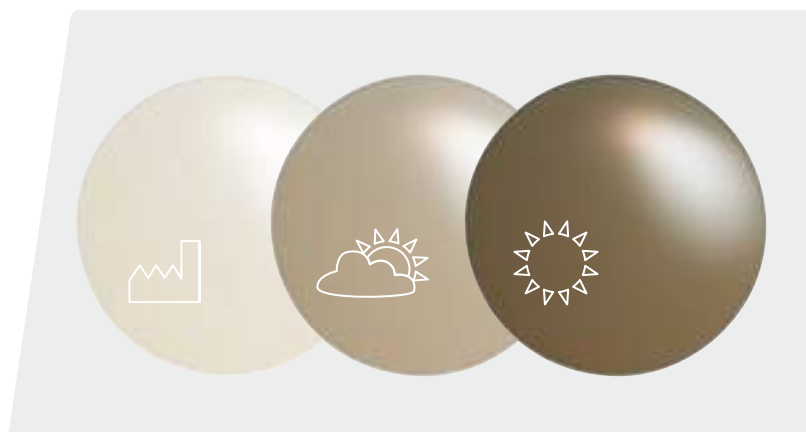

Super anti-reflection incl. easy-care layer

Anti-reflective coating is applied to the inside and outside of lenses by means of vapour deposition. It significantly reduces reflections on the surfaces. It offers a cosmetic advantage and increases light transmission. The easy-care layer makes the glasses easier to clean.

- Maximum reflection reduction
- Metal oxide is applied several times to each surface
- Residual reflection < 2%

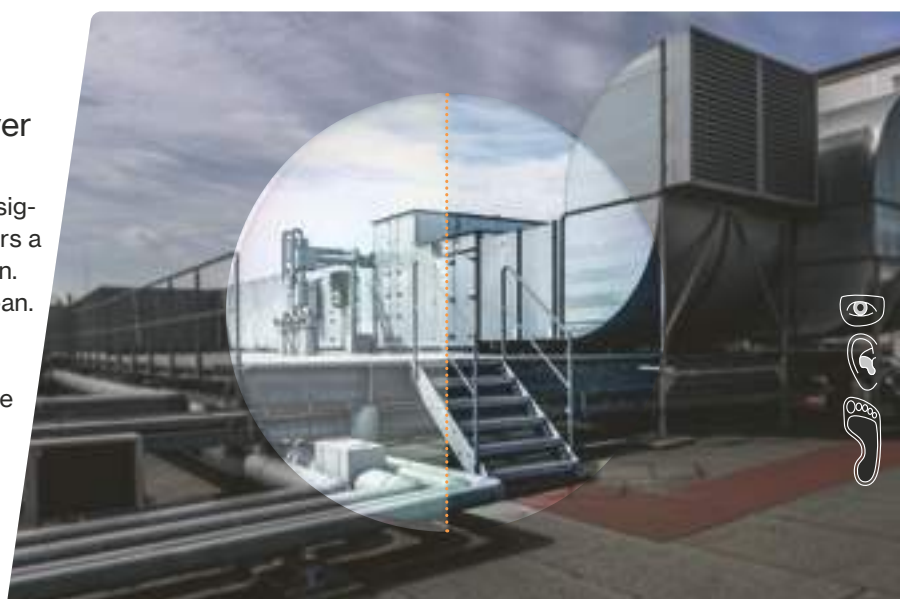

VDU spectacles
Metal frames

VDU spectacles
Metal frames

ideal for VDU work,
for use in workplaces where it is not
mandatory to wear safety spectacles
designs from classic to modern



6110062



6110063



6110064



6110065



6110066

	uvex RX 3119	uvex RX 3119	uvex RX 3120	uvex RX 3120	uvex RX 3121
Art. no.	6110062	6110063	6110064	6110065	6110066
Ref. no.	3119 6300 50/19	3119 1200 50/19	3120 1800 55/17	3120 3026 55/17	3121 1300 57/19
Lens diameter	50 mm	50 mm	55 mm	55 mm	57 mm
Bridge width	19 mm	19 mm	17 mm	17 mm	19 mm
Colour	rose gold, shiny	black, matt	silver, shiny	dark blue, matt	anthracite, shiny
Extras	Spring hinge	Spring hinge	Spring hinge	Spring hinge	Spring hinge

VDU spectacles
Metal frames



6110052



6110053



6110055



6110056



6110050



6110051



6110033



6110034

	uvex RX 3114	uvex RX 3115	uvex RX 3117	uvex RX 3118	uvex RX 3112	uvex RX 3113	uvex RX 3107	uvex RX 3108
Art. no.	6110052	6110053	6110055	6110056	6110050	6110051	6110033	6110034
Ref. no.	3114 1000 52/16	3115 4000 54/16	3117 1590 48/20	3118 7190 55/17	3112 1233 54/17	3113 1000 53/18	3107 1000 55/17	3108 1400 54/18
Lens diameter	52 mm	54 mm	48 mm	55 mm	54 mm	53 mm	55 mm	54 mm
Bridge width	16 mm	16 mm	20 mm	17 mm	17 mm	18 mm	17 mm	18 mm
Colour	black	bordeaux	grey, vintage	petrol, vintage	black, blue	black	black	gun



uvex

VDU spectacles

Plastic frames

VDU spectacles Plastic frames

ideal for screen work,
in workplaces where it is not man-
datory to wear safety spectacles
designs from classic to modern



6110060



6110059



6110061

Art. no.	uvex RX 3513 6110059	uvex RX 3514 6110060	uvex RX 3515 6110061
Ref. no.	3513 3000 50/20	3514 5441 49/19	3515 5426 55/18
Lens diameter	50 mm	49 mm	55 mm
Bridge width	20 mm	19 mm	18 mm
Colour	dark blue	havanna, red	havanna, matt

VDU spectacles
Plastic frames



6110046



6110048



6110037



6110039

	uvex RX 3510	uvex RX 3512	uvex RX 3506	uvex RX 3508
Art. no.	6110046	6110048	6110037	6110039
Ref. no.	3510 1025 52/17	3512 1341 52/18	3506 3329 55/16	3508 1000 54/18
Lens diameter	52 mm	52 mm	55 mm	54 mm
Bridge width	17 mm	18 mm	16 mm	18 mm
Colour	black, translucent	anthracite, red	blue, transparent	black



uvex

VDU spectacles

Titanium frames

Titanium uvex RX ti

ideal for screen work,
in workplaces where it is not man-
datory to wear safety spectacles
lightweight
allergy-neutral



6110057



6110058

Art. no.	uvex RX ti 3900	uvex RX ti 3901
Ref. no.	6110057	6110058
Lens diameter	3900 5500 53/16	3901 1400 56/17
Bridge width	53 mm	56 mm
Colour	16 mm	17 mm
	brown	gun



uvex high-fit



uvex high-fit hearing protection otoplastics

Customised hearing protection from uvex

**MADE FOR
YOUR EARS**
MADE IN **UVEX**



uvex hearing protection otoplastics are customised to fit the wearer's ear canal and provide the best possible protection in very noisy environments.

uvex high-fit hearing protection otoplastics are tested, certified and permitted for use in very noisy environments in accordance with EN 352. This hearing protection offers maximum wearer comfort over long periods thanks to its highly customised and pressure-free fit.

uvex offers a wide range of otoplastics in various materials and designs that provide different levels of insulation.

All materials used are free of hazardous substances and are tested regularly. The customised otoplastics have a service life of around five years, facilitating a commitment to sustainable retail.

The collection

uvex high-fit otoplastics are customised to the wearer and available in various versions (material/design/filter strength), as well as detectable variants.

uvex flex otoplastics



- flexible otoplastics hearing protection
- made of soft silicone or silicon-free thermo-plastic material
- exceptional wearer comfort thanks to the materials adapting to the user's ear canal
- available in various designs

The classifications are defined as follows:

- S – Signal hearing in railway track superstructure construction
- V – Signal hearing in road traffic
- X – extremely linear attenuation hearing protection. Suitable for people with hearing loss and musicians.
- W – Warning signal hearing, general

uvex duro otoplastics



- sturdy otoplastics hearing protection
- made of silicone-free acrylic material
- comfortable, smooth surface
- available in different designs and as active otoplastics hearing protection

- E – Signal hearing for locomotive drivers in railway operations
- E1 – Exceptionally well suited, particularly suitable for persons with impaired hearing
- E2 – Suitable

Appropriate information can be found in the individual products

uvex otoplastics headsets



- Headset solutions for communication and telephone calls in noisy workplaces
- for connecting to uvex high-fit RS otoplastics hearing protection
- available in different versions (wired or wireless)

Abbreviations:

- HC:** half-concha otoplastics
- FC:** full-concha otoplastics
- u-cut:** U-shape (material removal in the ear canal)
- RS:** real sound
- C-com:** wired headset
- B-com:** wireless headset
- B-com BM:** wireless headset with gooseneck microphone

uvex high-fit hearing protection otoplastics

Customised hearing protection from uvex

uvex as a partner for customised protective equipment

Noise-induced hearing loss is one of the most common occupational illnesses, usually developing slowly and painlessly. Noise does not just affect our hearing – it also has a negative effect on the human body as a whole. With its wide range of hearing protection otoplastics, uvex offers protection with maximum comfort and quality.



Ear moulding: Experts from uvex visit your premises to make moulds of your employees' ears, then uvex uses these moulds to create customised hearing protection.

Function testing: In the prevention guideline "Use of hearing protection earmolds", the DGUV defines a professional functional test before the product is first used but at the latest after six months.

We recommend testing the products at least every three years to ensure that the otoplastics offer the required level of protection.

Our service – your benefits

uvex offers maximum service with maximum flexibility.

Our extensive uvex otoplastics collection offers suitable hearing protection otoplastics for every employee.



uvex experts:

- specialists in on-site service
- qualified advisors in uvex customer service
- comprehensive uvex acoustic service partner network throughout Germany



uvex flexibility:

- on-site product consultation and customisation on request
- appointments for early, late or night shifts also available
- optimal planning via the uvex online appointment portal



uvex knowledge:

- decades of experience in acoustics and products under continuous development
- training courses/practical seminars can be provided for your employees (e.g. company doctors, occupational safety specialists)
- 'made in uvex' quality: commitment to a comprehensive quality system with a focus on production facilities in Germany/Europe

Steps to customised hearing protection

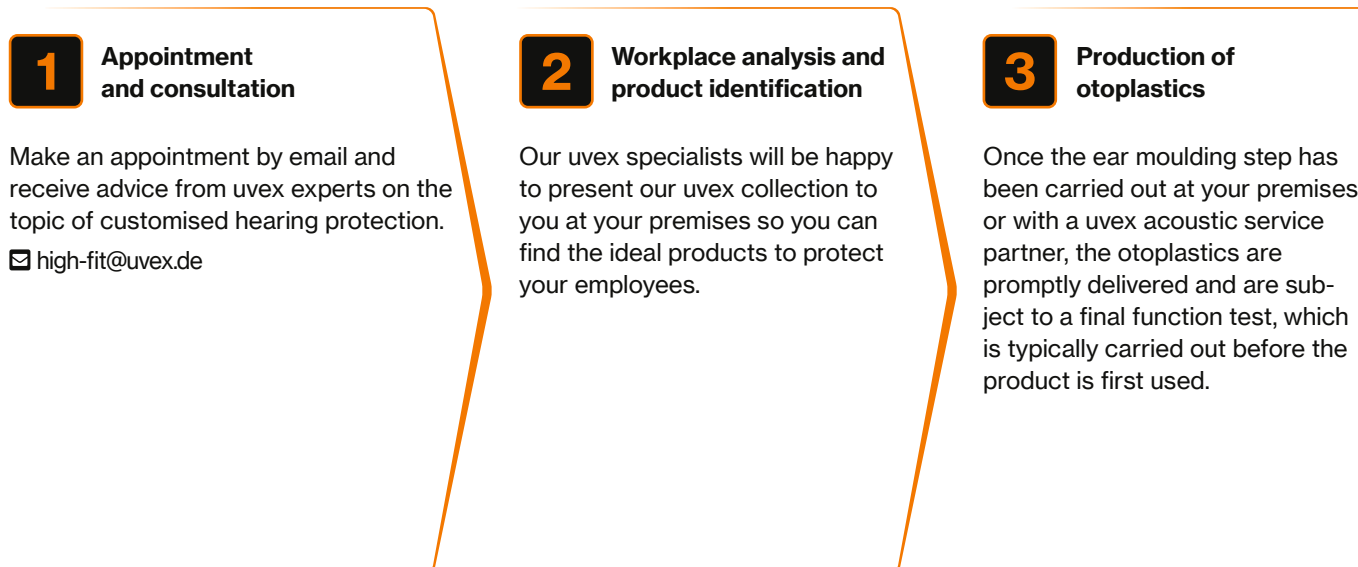

uvex C-com · uvex B-com
otoplastic headsets

uvex high-fit
otoplastic headsets

free choice of otoplastics
design and material
half- or full-concha
acrylic or silicone
linear filter element
compatible with uvex otoplastic
headsets



uvex C-com otoplastics headset
+ headset (binaural) with
gooseneck microphone



6177161

uvex B-com otoplastics headset
+ neckband (binaural)



6177162

uvex B-com BM otoplastics headset
+ neckband (binaural)
with gooseneck
microphone

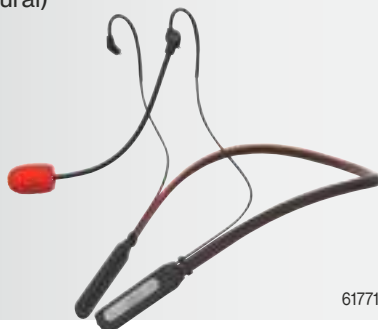

6177163

uvex C-com · uvex B-com · uvex B-com BM

- specially developed headset with directional microphone
- available as a wired headset with a jack connection and gooseneck microphone, or as a stereo wireless headset with or without gooseneck microphone
- ideal for telephony and communication in very noisy environments
- excellent voice and sound quality in very noisy environments
- volume can be controlled via the integrated remote control
- make hands-free phone calls in the workplace or at the wheel
- practical and secure when worn with uvex high-fit RS otoplastic hearing protection and ear hooks

Areas of application:

Workplaces with high communication requirements, musicians, telephony

	uvex C-com	uvex B-com	uvex B-com BM
Art. no.	6177161	6177162	6177163
Standard	EN 352-2;9	EN 352-2;9	EN 352-2;9
Compatible with	uvex high-fit flex RS, uvex high-fit duro RS		
Order unit	PC	PC	PC



Individual adjustment
to the ear shape



Protection against noise
during telephone calls



Maximum
wearer comfort



Communication in
noisy workplaces



Hands-free
working

uvex high-fit
RS otoplastics



uvex high-fit flex RS · uvex high-fit duro RS

- otoplastic hearing protection tailor-made to fit the wearer's ear canal
- new linear filter technology in different filter strengths
- optimal linear hearing protection over the entire frequency range
- available in silicone or acrylic
- available in half- or full-concha designs
- compatible with uvex communication headsets

Areas of application:
Workplaces with high communication requirements, musicians, telephony

uvex high-fit flex RS 22	HC	FC	FC detec
Art. no.	6171022	6171052	6171142
Marking	S, W, X, E1	S, W, X, E1	S, W, X, E1
SNR	22 dB (grey)	22 dB (grey)	22 dB (grey)
HML value	H 21 dB; M 20 dB; L 19 dB		
Colour	transparent	transparent	transparent
Order unit	PR	PR	PR

uvex high-fit duro RS 20	HC	FC	FC detec
Art. no.	6171020	6171050	6171140
Marking	S, W, X, V, E1	S, W, X, V, E1	S, W, X, V, E1
SNR	20 dB (black)	20 dB (black)	20 dB (black)
HML value	H 18 dB; M 20 dB; L 18 dB		
Colour	transparent	transparent	transparent
Order unit	PR	PR	PR

uvex high-fit duro RS 26	HC	FC	FC detec
Art. no.	6171026	6171056	6171146
Marking	S, W, V, E2	S, W, V, E2	S, W, V, E2
SNR	26 dB (grey)	26 dB (grey)	26 dB (grey)
HML value	H 28 dB; M 23 dB; L 20 dB		
Colour	transparent	transparent	transparent
Order unit	PR	PR	PR

Both half- and full-concha designs are available in silicone and acrylic

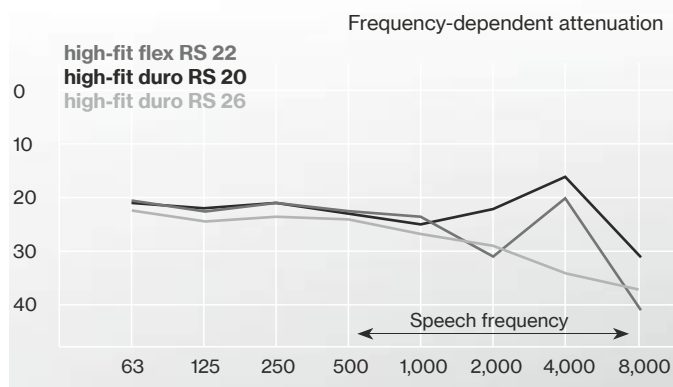

► We will be happy to change the filter element for you if and when necessary.

uvex otoplastics are made of transparent materials. They are marked left and right with an engraving for ease of fitting and also come with different coloured cord holders.

For an additional fee, we can manufacture your otoplastics in black, white, orange, purple, green, pink



uvex high-fit flex RS otoplastics are also available in red and/or blue upon request, at no extra cost



uvex high-fit
Soft silicone otoplastics

uvex high-fit
Soft silicone otoplastics

soft silicone material
robust design with grip
a wide range of options in
different filter strengths
high fit flex also available in
detectable variant



6170223
6170226
6170230

uvex high-fit flex LS

- otoplastic hearing protection individually adjusted to the ear canal with laser-produced stainless steel filter
- best possible protection due to the perfect fit and a high level of wearer acceptance
- high protection capacity, up to 30 dB SNR, can also be chosen
- high level of wearer comfort due to the soft silicone material
- easy handling with comfortable grip
- antibacterial nano-coating

uvex high-fit flex LS			
Art. no.	6170223	6170226	6170230
Standard	EN 352-2:2020	EN 352-2:2020	EN 352-2:2020
Marking	W	S, W, V, X, E1	S, W, V, E1
SNR	23 dB (LS filter)	26 dB (LS filter)	30 dB (LS filter)
HML value	H 25 dB; M 20 dB; L 18 dB	H 27 dB; M 22 dB; L 21 dB	H 31 dB; M 27 dB; L 25 dB
Colour	transparent	transparent	transparent
Order unit	PR	PR	PR

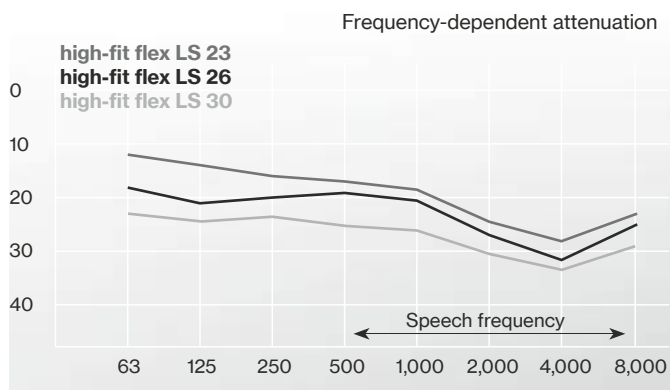

► We will be happy to change the filter element for you if and when necessary.

uvex otoplastics are made of transparent materials. They are marked left and right with an engraving for ease of fitting and also come with different coloured cord holders.

For an additional fee, we can manufacture your otoplastics in black, white, orange, purple, green, pink



uvex high-fit flex LS otoplastics are also available in red and/or blue upon request, at no extra cost



uvex high-fit
Soft silicone otoplastics



uvex high-fit flex · uvex high-fit flex detec

- otoplastic hearing protection individually adjusted to the ear canal
- best possible protection due to the perfect fit and a high level of wearer acceptance
- available in different filter strengths
- high level of wearer comfort with soft silicone material
- easy handling with comfortable grip
- antibacterial nano-coating
- detectable variants with a metal ball bearing and a detectable blue cord to ensure they can be found by metal detectors.

uvex high-fit flex / detec			
Art. no.	6170023	6170026	6170028
Art. no. detec	6170423	6170426	6170428
Standard	EN 352-2	EN 352-2	EN 352-2
Marking	-	S, W, E2	S, W, E1
SNR	23 dB (green)	26 dB (black)	28 dB (yellow)
HML value	H 27 dB; M 19 dB; L 15 dB	H 28 dB; M 23 dB; L 20 dB	H 29 dB; M 24 dB; L 22 dB
Colour	transparent	transparent	transparent
Order unit	PR	PR	PR

Frequency-dependent attenuation

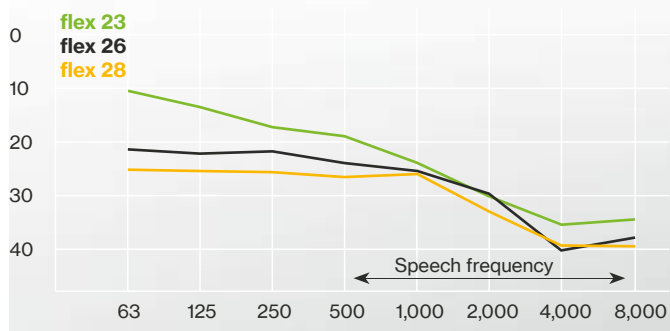

► We will be happy to change the filter element for you if and when necessary.

uvex otoplastics are made of transparent materials. They are marked left and right with an engraving for ease of fitting and also come with different coloured cord holders.

For an additional fee, we can manufacture your otoplastics in black, white, orange, purple, green, pink



uvex high-fit flex RS otoplastics are also available in red and/or blue upon request, at no extra cost



uvex high-fit
Soft silicone otoplastics

uvex high-fit
Soft silicone otoplastics

very light u-cut design
extremely flexible and comfortable
various designs can be selected



6170315
6170320
6170326

uvex high-fit u-cut com4

- otoplastic hearing protection customised to the wearer's auditory canal
- soft silicone material (dermatologically tested)
- removable otoplastics for the auditory canal offer maximum flexibility
- ideal for leisure activities thanks to small auditory canal design without grip
- with anti-bacterial nano-coating

Areas of application:

- sleeping, flying, shared office spaces, phone calls, concerts, work areas without designated noise areas

Please note that our u-cut com4 model with an SNR of 15 dB is not suitable or certified for use in designated noise areas.

uvex high-fit u-cut com4			
Art. no.	6170315	6170320	6170326
Standard	EN 352	EN 352	EN 352
SNR	15 dB	20 dB	26 dB
Colour	transparent	transparent	transparent
Order unit	PR	PR	PR

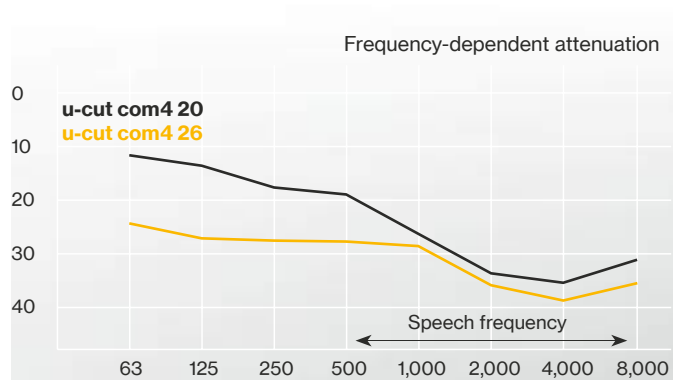

uvex otoplastics are made of transparent materials. They are marked left and right with an engraving for ease of fitting and also come with different coloured cord holders.

For an additional fee, we can manufacture your otoplastics in black, white, orange, purple, green, pink



uvex high-fit otoplastics are also available in red and/or blue upon request, at no extra cost



uvex high-fit

Soft silicone otoplastics



6170720
6170726



6170703
6170704

uvex high-fit u-cut HC

- uvex high-fit u-cut in half-concha or full-concha design according to custom ear impression
- soft silicone material (dermatologically tested)
- removable otoplastics for the auditory canal offer maximum flexibility and can therefore compensate for strong jaw movements
- due to the special design, these otoplastics are softer, lighter and more flexible in the auditory canal and in the outer ear, offering maximum wearer comfort
- with anti-bacterial nano-coating

Areas of application:

- for use in any high-temperature area and by people with pressure-sensitive ears.

uvex high-fit u-cut 20	HC	FC
Art. no.	6170720	6170703
Marking	-	-
SNR	20 dB (black)	20 dB (black)
HML value	H 25 dB; M 17 dB; L 12 dB	H 25 dB; M 17dB; L 12 dB
Colour	transparent	transparent
Order unit	PR	PR

uvex high-fit u-cut 26	HC	FC
Art. no.	6170726	6170704
Marking	S, W, E2	S, W, E2
SNR	26 dB (yellow)	26 dB (yellow)
HML value	H 28 dB; M 23 dB; L 21 dB	H 28 dB; M 23 dB; L 21 dB
Colour	transparent	transparent
Order unit	PR	PR

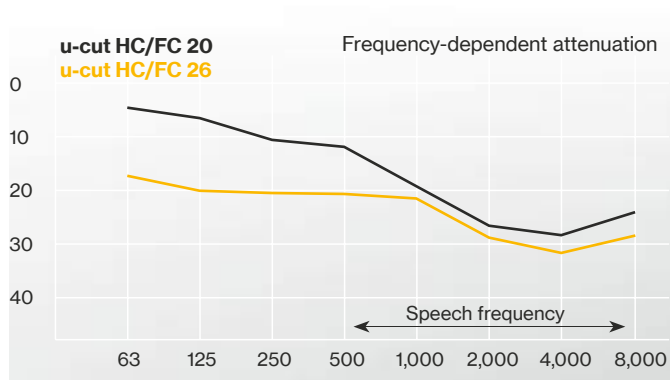

► We will be happy to change the filter element for you if and when necessary.

uvex otoplastics are made of transparent materials. They are marked left and right with an engraving for ease of fitting and also come with different coloured cord holders.

For an additional fee, we can manufacture your otoplastics in black, white, orange, purple, green, pink



uvex high-fit otoplastics are also available in red and/or blue upon request, at no extra cost



uvex high-fit
Silicone-free otoplastics

uvex high-fit
Silicone-free otoplastics

ideal for paint-processing industries
silicone-free thermoplastic material
silicone-free shape-retaining acrylic material
high-fit duro variant also available as detectable variant



uvex high-fit temp flex

- otoplastic hearing protection individually adjusted to the ear canal
- fully silicone-free
- best possible protection due to the perfect fit and a high level of wearer acceptance
- available in different filter strengths
- easy handling with comfortable grip
- adapts perfectly to the anatomy of the wearer: on insertion, the otoplastic is dimensionally stable; the material gets softer after a few minutes due to the temperature in the ear canal

Areas of application:

- ideally suitable for the paint-processing industry

uvex high-fit temp flex		
Art. no.	6170524	6170528
Standard	EN 352-2	EN 352-2
Marking	-	S, W, E2
SNR	24 dB (black)	28 dB (yellow)
HML value	H 28 dB; M 21 dB; L 16 dB	H 30 dB; M 24 dB; L 21 dB
Colour	transparent	transparent
Order unit	PR	PR

Frequency-dependent attenuation

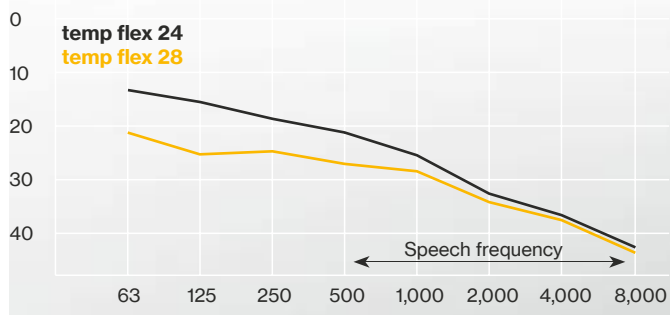

► We will be happy to change the filter element for you if and when necessary.

uvex otoplastics are made of transparent materials. They are marked left and right with an engraving for ease of fitting and also come with different coloured cord holders.

uvex high-fit
Silicone-free otoplastics



6170824
6170828
6170832

uvex high-fit duro · uvex high-fit duro detec

- otoplastic hearing protection individually adjusted to the ear canal made from dimensionally stable duroplast material
- fully silicone-free
- detectable variants with a metal ball bearing and a detectable blue cord to ensure they can be identified by metal detectors.
- best possible protection with perfect fit and high level of wearer acceptance
- available in different filter strengths
- smooth, even surface
- easy handling with comfortable grip
- antibacterial nano-coating

Areas of application:

- ideally suitable for the paint-processing industry and for areas with very fine dust
- uvex high-fit flex detec ideally suited for sectors in the food industry

uvex high-fit duro			
Art. no.	6170824	6170828	6170832
Standard	EN 352-2	EN 352-2	EN 352-2
Marking	-	-	S, W, V, E1
SNR	24 dB	28 dB	32 dB
HML value	H 30 dB; M 21 dB; L 15 dB	H 32 dB; M 24 dB; L 18 dB	H 33 dB; M 29 dB; L 27 dB
Colour	transparent	transparent	transparent
Order unit	PR	PR	PR

Frequency-dependent attenuation

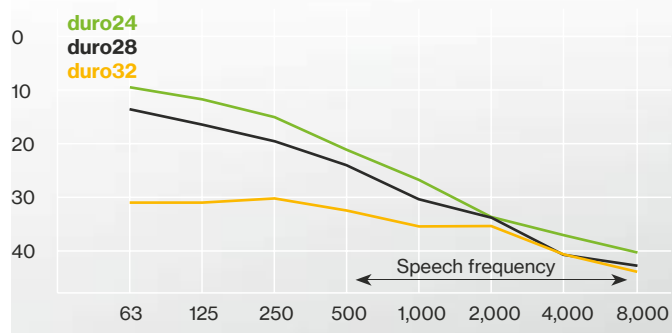

uvex otoplastics are made of transparent materials. They are marked left and right with an engraving for ease of fitting and also come with different coloured cord holders.

For an additional fee, we can manufacture your otoplastics in red and blue



uvex high-fit
Industrial otoplastics



6170840

uvex high-fit duro active

- active otoplastic hearing protection – tailor-made to the individual's ear canal
- finely tuned and highly sensitive microphones
- best directional and ambient acoustics
- very high level of passive insulation
- outstanding high-tech amplifier technology for impulse noise
- protection in the event of a shot or bang (up to 164 dB)
- electronic limitation closes in less than 10 milliseconds
- cerumen filter system protects against moisture and sweat
- assists the wearer in situations where hearing and communication may be difficult, such as when communicating in very noisy workplaces or where early detection of quiet sounds is required

Areas of application:

Workplaces with high communication requirements, very loud environments, employees with hearing loss or those affected by impulse sounds

uvex high-fit duro active	
Art. no.	6170840
Norm	EN 352-2, EN 352-7
Standard	26 dB
Colour	black

Frequency-dependent attenuation

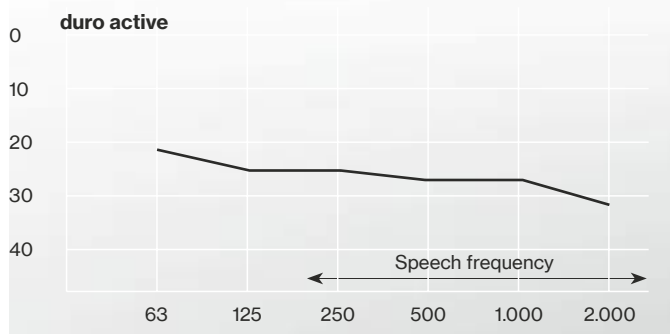

Included

- active otoplastic hearing protection – tailor-made to the individual's ear canal
- hard shell case
- 1 blister pack of zinc-air batteries, size 312
- 1 blister pack of earwax filters
- uvex cleaning cloths for otoplastics
- user information



Replacement batteries	
Art. no.	6177157
Type	1 PC blister pack of 6 zinc-air batteries, type 312
Order quantity multiples	10 PC

Replacement cerumen filters	
Art. no.	6177158
Type	1 PC blister pack of 8 filters
Order quantity multiples	5 PC

uvex OTOCheck

Instructions for checking the function of your equipment online

uvex OTOCheck allows you to check the function of your uvex otoplastic hearing protection online in a quick and easy process. After completing the straightforward registration process, you will be able to access an overview of your otoplastics orders and view the status of your function tests using the simple traffic light system.

Function testing:

In the prevention guideline "Use of hearing protection earmolds", the DGUV defines a professional functional test before the product is first used but at the latest after six months. We recommend testing the products at least every three years to ensure that the otoplastics offer the required level of protection.



Your benefits at a glance:



- ✓ Check the function of your equipment using a straightforward, digital process
- ✓ Simple registration
- ✓ Create multiple user profiles on one account
- ✓ Clear data management for your otoplastics orders
- ✓ Check the status of function tests that have already been completed
- ✓ Documentation of all test reports for quality assurance purposes

What you need for uvex OTOCheck:

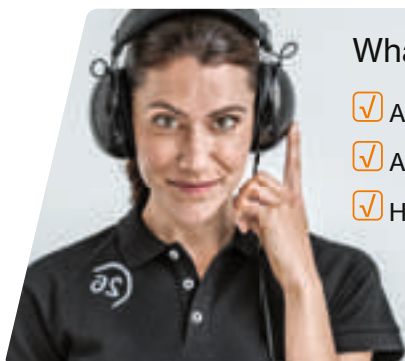

- ✓ A computer, tablet or laptop
- ✓ An Internet connection
- ✓ Headphones



We recommend headphones that are suitable for uvex OTOCheck (article number 6178121). Please get in touch with us and we will be happy to advise you.

uvex high-fit Special features



Included

uvex high-fit otoplastics are supplied in a zipped case, including textile cord, cleaning rod, cleaning cloths and user information.

Silicone otoplastics are delivered with a tube of audinell gel.

uvex click case

- small click case for otoplastics

uvex click case	
Art. no.	6177115
Order quantity multiples	10 PC

uvex clear otoplastics

- silicone-free towelettes for quick and easy cleaning of hearing protection otoplastic, suitable for all otoplastic materials
- packaging: 30 per box

uvex clear otoplastics	
Art. no.	6177116
Order unit	PC
Contents	30 towelettes per PC

uvex high-fit band

- neck handle for hearing protection otoplastics in zip-up case
 - easy to attach the otoplastic to the band using colour-coded connector sleeves
 - no disruptive transmission noise because the band prevents the cord rubbing on clothing
 - band significantly relieves strain
 - comfortable to wear around the neck during breaks
- Areas of application:
- ideal for activities with frequent and/or fast head movements

Band	
Art. no.	6177112
Order unit	PC

uvex high-fit replacement kits

Detectable replacement kit for:

- uvex high-fit flex detec
- uvex high-fit duro detec

Detectable replacement kit for:

- uvex high-fit flex com detec

Fabric cord replacement kit	
Art. no.	6177156
Design	comprising 900 mm textile cord and a pair of fastening sleeves (red/blue)
Order quantity multiples	10 PC

Detectable replacement kit	
Art. no.	6177111
Design	consists of an elastic cord 800 mm (blue, detectable) and a pair of connector sleeves (blue, detectable)
Order quantity multiples	10 PC

Detectable replacement kit	
Art. no.	6177211
Design	consists of an elastic cord 800 mm (blue, detectable) and a pair of connector sleeves each (blue, detectable), sealing plugs (red/blue) and disposable plugs
Order quantity multiples	10 PC



uvex medicare



uvex medicare

Orthopaedic solutions for uvex safety shoes

**MADE FOR
YOUR FEET**
MADE IN **UVEX**



The customised solutions provided by uvex medicare solve foot-related medical problems in the workplace and offer individual, expertly designed orthopaedic solutions.

uvex medicare supplies orthopaedic insoles as well as orthopaedic shoe adjustments for uvex safety shoes.

The orthopaedic uvex medicare solutions are tested with uvex safety shoes and certified in accordance with DIN EN ISO 20345.

German Social Accident Insurance (DGUV) regulation 112-191 and Austrian ÖNORM Z 1259 describe that a fully certified orthopaedic solution must be used at working places. Wearing privately purchased orthopaedic insoles in safety shoes is therefore not permitted.

All of the materials uvex uses are free of hazardous substances and are tested regularly.

The collection

uvex orthopaedic comfortable customised inserts/ uvex orthopaedic adjustments



All uvex safety shoes that are marked with the uvex medicare symbol can be fitted with uvex orthopaedic comfortable customised inserts or an orthopaedic adjustment.



The uvex medicare + logo indicates that both orthopaedic customised inserts and orthopaedic adjustments are available.

uvex motion 3XL



Amazingly spacious:

- significantly larger inside than other comparable safety shoes
- considerably wider than size 15
- exceptionally high, anatomically shaped toe cap
- pressure points eliminated

uvex as a partner for customised protective equipment

Scientific studies prove that well over half the adult population suffers from orthopaedic problems such as flat feet, skewfoot, splayfoot or fallen arches. These conditions have an undisputed effect on the entire musculoskeletal system and physical performance.

With our orthopaedic uvex medicare solutions for uvex safety shoes and the uvex motion 3XL, we offer various orthopaedic protection solutions that are tailored to each individual employee. Maximum comfort and quality guaranteed.

Our service – your benefits

uvex offers maximum service with maximum flexibility. Our experts are happy to advise you on professional and flexible solutions, tailored to the individual requirements of your company.



uvex experts:

- specialists in on-site service
- qualified advisors in uvex customer service
- comprehensive uvex orthopaedics service partner network throughout Germany



uvex flexibility:

- on-site product consultation and customisation on request
- appointments for early, late or night shifts also available
- optimal planning via the uvex online appointment portal



uvex knowledge:

- decades of experience in orthopaedics and products under continuous development
- training courses/practical seminars can be provided for your employees (e.g. company doctors, occupational safety specialists)
- 'made in uvex' quality: commitment to a comprehensive quality system with a focus on production facilities in Germany/Europe

Steps to orthopaedic solutions for uvex safety shoes

1 Appointment and consultation

Make an appointment by email and receive advice from uvex experts.

✉ medicare@uvex.de

2 Workplace analysis and product identification

Our uvex experts will be happy to introduce you to our uvex medicare programme at your premises. Each orthopaedic medicare solution is designed using a medical diagnosis and a blueprint of the foot.

Together, we can find the ideal products for you so you can protect your employees.

3 Complete orthopaedic solution

Delivery is quick and easy.

Contact us for more information with no obligation.



Personal insoles are not permitted in safety shoes.



Orthopaedic solutions for uvex safety shoes

Our feet are extremely important for our daily life – after all they help us to stand and move from A to B. It is therefore particularly important to protect our feet in working life – whether that's because we're running, kneeling, working on a machine or in order to prevent an occupational accident. Safety shoes are tested and certified at regular intervals by independent test institutes for protective features, such as ESD, cap testing etc. and for effectiveness, in accordance with the requirements of DIN EN ISO 20345.

In order to ensure that all safety-related protective features are still guaranteed in the event of an orthopaedic change to the safety shoe, orthopaedic insoles must only be used in combination with tested, orthopaedic materials.

This means that personal orthopaedic insoles are not allowed in safety shoes. All uvex medicare products have therefore been tested and certified in combination with uvex safety shoes.



uvex medicare

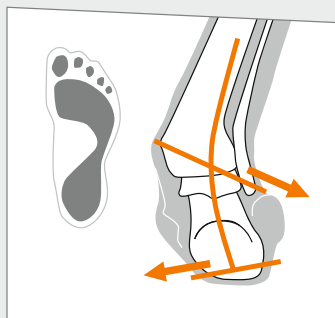

Skewfoot

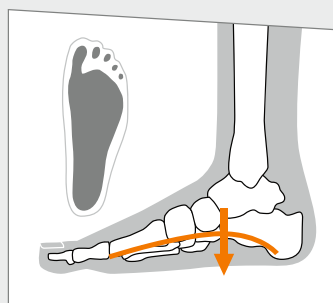

Flatfoot

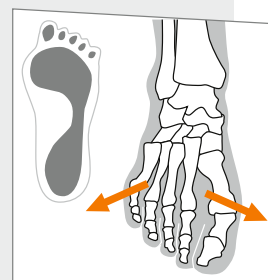

Splayfoot

MADE FOR YOUR FEET

MADE IN UVEX



How do I get an orthopaedic adjustment for uvex safety shoes?

uvex requires the footprint of your feet. This can be taken by our field service on site or you can use our uvex medicare footprint set – a convenient, simple and flexible way to self-record the footprint. All order details can be found on the order form in the folder.



Instructions



1 Separate the white sheet from the clear protective film and place the film over the blueprint, making sure that there are no wrinkles.



2 Place this on a flat surface and place your foot in the middle of it, putting your full body weight onto it. Draw around the foot with a pen.



3 Peel off the transparent film and remove the blueprint. Now place the film with your footprint on the chequered backing sheet and smooth it out, ensuring that there are no creases.

Repeat the process for your other foot.

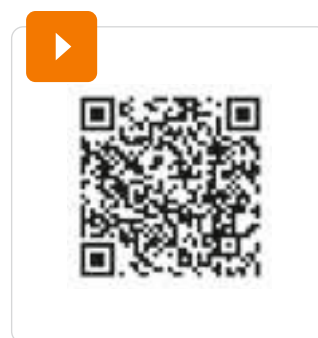

Watch our How-to video for a clear explanation of the individual steps.

Simply scan the QR code.



uvex medicare

Comfortable customised inserts –
Insert technology for tailor-made treatment

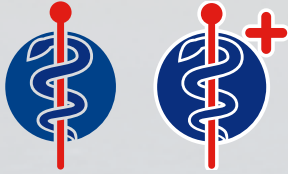

All products suitable for orthopaedic foot protection are indicated in this catalogue with the uvex medicare symbol.

uvex medicare logo

Certified for orthopaedic inserts

uvex medicare + logo

Certified for orthopaedic inserts and shoe adjustments

EVA soft-foam technology

Various Medical Concepts

Applicable – depending on classification:

- conventional orthopaedics
- sensorimotor function
- Spiraldynamik®

- supports correct biomechanical foot rolling
- does not require to be 'broken in' and high wearer comfort



uvex 3D hydroflex® foam

- optimum moisture absorption and release
- excellent shock absorption in high-strain zones such as the ball and heel of the foot
- smooth surface
- excellent abrasion resistance

Orthopaedic Adjustment

- modular concept
- adapts to assist natural movement

Supporting Core

- 2 levels of shore hardness (medium/soft) selected according to requirements: Individually adaptable to body type and support requirements
- high support, guiding and shock absorption properties through soft, raised heel shell

Orthopaedic uvex comfort custom insole
Art. no. 6499902

uvex medicare
Orthopaedic shoe adjustments –
Professional and discreet



Orthopaedic shoe adjustments



6499911

Shoe lift

A shoe lift is required to balance legs of different length.

A shoe lift should never exceed 3 cm.

Orthopaedic shoe adjustments	
Art. no.	6499911
Design	orthopaedic shoe lift up to 1 cm per side

Art. no.	6499912
Design	shoe lift per additional cm (up to max. 3 cm) per side



6499913

Roller sole

A roller sole eases the burden on the feet during your stride. The precise effect is governed by the location of the pressure point. This helps adjust the length of your stride.

Art. no.	6499913
Design	rocker sole

Art. no.	6499914
Design	butterfly roller

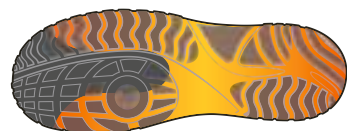

6499914

Butterfly roller

A butterfly roller reduces the burden on sensitive metatarsal bones by dissipating the pressure caused by each stride. By moving the pressure point, you can create an extra rocking effect.

Art. no.	6499915
Design	external or internal edge lift

Art. no.	6499907
Design	sole stiffener (only as addition in connection with a shoe adjustment initial position)

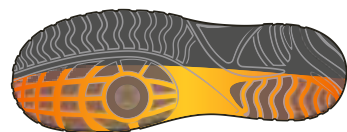

6499915

Outer and inner sole wedges

By using a wedge, you can adjust the slope beneath the feet in a standing position and correct the line of your stride when walking.



uvex

uvex medicare
uvex motion 3XL



Where the
uvex
motion 3XL
can help



Diabetes



Foot misalignment or deformations



Ankle inflammation and osteoarthritis



Joint blockages, tendon contractures, heel spur



Lower leg problems



64963



uvex motion 3XL · Shoe S3L FO SR

General features:

- extremely wide innovative shoe
- virtually seam-free construction
- pressure points virtually eliminated
- mostly metal-free
- largely free from silicone and plasticiser
- one of the lightest therapeutic safety shoes of its class
- helps to reduce downtime due to ill-health
- offers enough room for diabetes-adapted foot bedding

Protection characteristics:

- meets ESD specifications with bleeder resistor under 35 megaohms
- non-slip outsole and non-metallic penetration-resistant insert – despite high flexibility of the shoe
- 100 % metal-free uvex medi-cap toe cap – compact, anatomically formed, not thermally conductive and with good side stability
- secure standing even on ladders due to optimal profile design with self-cleaning studs and additional stable arch

Comfort features:

- perfect foot climate at all times thanks to breathable lining and outer shoe material
- ergonomic lightweight construction and above-average shock absorption increases wearer comfort and prevents fatigue
- comfortable and virtually pressure-free
- cushioned shaft edge, three-layered padded lining
- customisable complete orthopaedic package
- uvex medicare certified up to 3 cm raised sole
- additional movement space in toe area 1 cm

Areas of application:

- medium area of application, in sectors such as chemical industry, transport and logistics, energy, machine construction and metal processing
- also suitable for therapeutic purposes, e.g. diabetic care

uvex motion 3 XL	Shoe S3L FO SR
Art. no.	64963
Width	> 15
Standard	EN ISO 20345 S3L FO SR
Upper material	breathable, water-resistant high-tech microvelour
Size	35 to 50



uvex medicare

uvex motion 3XL safety footwear – functionality in every detail



Complete orthopaedic package

Construction material comprising soft, conductive EVA 6 mm thick foam, in combination with orthopaedic inserts with EVA core.

Minimal seams

To prevent potential rubbing points, the shoes have only three seams which align with the movement direction of the foot. A further feature that reduces pressure points.

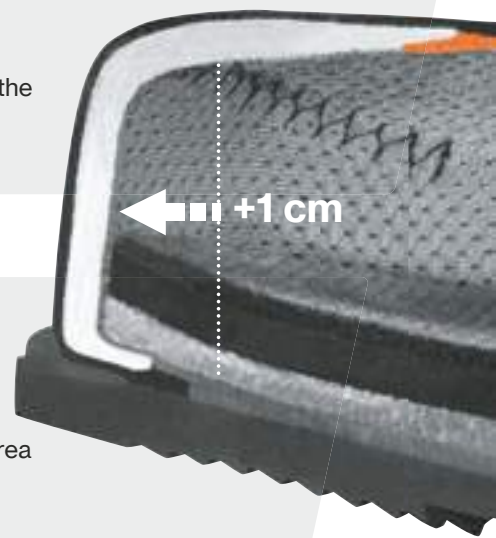

Secure and adjustable lacing system

Extremely soft, padded tongue with external individually adjustable lacing system.

Padded shoe shaft

Special padding in the collar, ankle and achilles tendon area prevent pressure points.

Soft, elasticated transition

The transition from toe cap to tongue protects the metatarsophalangeal (MTP) joints at the base of the toes.



Size comparison

Exceptionally high, anatomically shaped toe cap

The extremely high and wide uvex **medi-cap** ensures sufficient room for deformed feet (e.g. hammer, claw and mallet toes), a splint, an inner shell or a light foot bandage, so the risk of pressure points is reduced. In addition, this model offers good freedom of movement around the toes taking into account the big toe joint.

Increased space

Additional space for movement to reduce pressure points.

66%

more volume

Maximum comfort

Triple-layer lining with ultra-soft padding.

20%

more width

Generous foot width

Considerably wider than size 15. Ample room for inserting a thick insole, e.g. special diabetic insole.

uvex motion 3XL

A true "space miracle"



normal cap

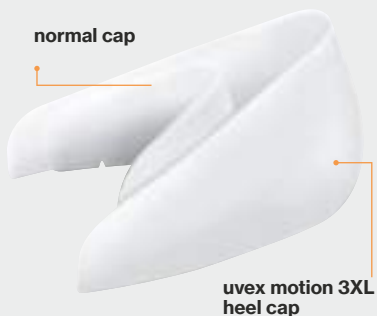

uvex motion 3XL heel cap

Extended heel cap

The heel cap is extended both inside and outside which ensures optimum heel guidance. This improves body static and increases stability.



All-round cap for impact protection

All-round shoe casing increases protection for wearer and the product life of the shoes.

Metal-free toe cap and midsole

Penetration-resistant sole and toe cap of high-tech plastics fulfil requirements of S3 shoes in accordance with norm EN ISO 20345:2011.





You can find more information at uvex-academy.com

uvex academy

Prescription spectacles and workplace safety

The common key features of prescription safety spectacles are that they compensate the wearer's defective vision and protect the eyes from mechanical and optical influences. This seminar will enable participants to act as a competent representative within the company for prescription safety spectacles right through to fitting.

- Ability to determine the necessary parameters for fitting prescription spectacles
- Practical demonstration of selection, consultation, and fitting of prescription safety glasses
- Instruction regarding the best care and handling of prescription safety spectacles

Target group

Those responsible for the work-related health and safety of employees within a company and/or those who are to fit prescription safety spectacles, such as safety officers, company doctors and their support staff.



- Information regarding legal regulations, test specifications and standards
- Sharing knowledge about prescription safety spectacles
- Explanation of the different types of lens and frame materials available, their specific features and properties
- Explanation of the various focus types and their best use
- Assessment of the risks in the respective workplace and selection of the most appropriate prescription safety spectacles

For further information and to register visit uvex-academy.com, phone +49 911 9736-1710 or e-mail academy@uvex.de





Workwear Protective Clothing



Product system planet series › Protective clothing and workwear

uvex has developed the **protecting planet** icon, to help raise awareness of its commitment to achieving increased sustainability. Based on the brand claim, **protecting people**, our sustainable approach integrates three core interlinked pillars – **ecology, economy** and **social responsibility**, that are incorporated throughout the business to improve our sustainability performance.

This explains the comprehensive audit, measurement and evaluation management process uvex undertakes along the entire value chain to ensure its products are as sustainable as possible.

uvex collection 26 planet

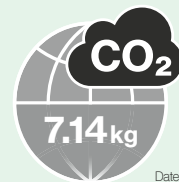

Date created 08/2023*

protecting planet
by using bio-based material

Clothing

- › all K26 planet products are made from natural fibres
- › from hemp, maize, bamboo and algae, through to the already well-known organic cotton and lyocell
- › the accessories used are also of natural origin: bamboo buttons and a uvex logo badge made of apple leather

70103



protecting planet

by using environmentally-friendly packaging

Packaging

- › individual packaging in polybags made from post-consumer waste



protecting planet

by saving water //
by saving energy

Production

- › use of renewable energy
- › short transport routes and less environmental impact thanks to being 75 percent produced in Europe
- › little water is used in the cultivation and production process of hemp and algae



The uvex brand is our responsibility

We have been producing and selling high-quality products for the protection of people in sport, leisure and work for **over 90 years**. And if you want to protect people, **you have to take responsibility**.

It is precisely from this mission that our obligation derives to act in a **sustainable, social and socially-responsible** manner.

uvex workwear

Organisational measures:

Leasing laundry suitability:

A large part of our range, recognisable by the "INDUSTRIAL WASH" symbol, has been specially developed for the high demands of leasing out workwear. These garments remain in circulation permanently until they wear out. Industrial laundering can significantly reduce water, energy and detergent consumption.

Use of high-quality materials:

The use of high-quality materials in combination with professional workmanship ensures the longevity of our products.

Manufacturing expertise:

"Designed and made in Europe" are the foundations of our quality promise. We help reduce CO₂ with our short transport routes.

Networks with our partners:

We maintain long-term business relationships to ensure compliance with our social standards. Some of our production facilities have been trusted and reliable partners for decades.

Waste prevention:

By using software-supported layer optimisation in fabric cutting, we reduce waste to a minimum.



Sustainable packaging

Polybags made from recycled polyethylene



Sustainable materials



TENCEL™ and recycled polyester for sustainability¹

The TENCEL™ lyocell fibres, made from the renewable raw wood material, contribute to ecological balance through their complete integration into the natural cycle. The raw material comes from near-natural forests and sustainably managed plantations. Production takes place in a closed manufacturing process, in which pulp is converted into cellulose fibres with high resource efficiency and a low ecological impact. The fibre properties are characterised by breathability, colour stability and low bacterial growth.

Other sustainable materials

The K26 planet collection uses only materials of natural origin. Fibre components such as hemp, algae, bamboo and organic cotton are used. The hemp plant is very resistant and requires little water in cultivation. This is reflected in the fact that the materials have a high tear resistance and durability. The algae fibres have an impressive level of skin compatibility, as they absorb a lot of nutrients from the seas.

¹TENCEL™ is a registered brand of the Lenzing group



uvex

uvex suXXeed greencycle planet

Sustainable workwear through and through

With the uvex suXXeed greencycle planet collection, we have succeeded in creating the very first biodegradable workwear. Suitable for both men and women working in warehouses, offices or for recreation, the collection offers a timeless look and even has Cradle to Cradle™ certification.



Worker shirt

Art. no. 88812 ■ anthracite
Size S to 6XL
Material 48% cotton, 48% polyester, 4% elastane, approx. 230g/m²
 INDUSTRIALWASH●●

Description: • biodegradable polyester and elastane • regular fit • button panel in the front centre • turndown collar • one breast pocket with glasses and pen loop • cuffs with button fastening • Cradle to Cradle™ gold certified

Bermuda

Art. no. 88811 ■ anthracite
Size 42 to 64
Material 48% cotton, 48% polyester, 4% elastane, approx. 230g/m²
 INDUSTRIALWASH●●

Description: • biodegradable polyester and elastane • regular fit • ergonomic cut • crotch insert • elasticated waistband at rear, buttoned fly • left side pocket with button fastening • folding rule pocket, as well as pen pocket on the right • back pockets • uvex logo engraved • Cradle to Cradle™ gold certified



Cargo trousers

men
Art. no. 88868 ■ anthracite
Size 42 to 64, 90 to 110

women
Art. no. 88876 ■ anthracite
Size 34 to 54
Material 48% cotton, 48% polyester, 4% elastane, approx. 230g/m²
 INDUSTRIALWASH●●

Description: • biodegradable polyester and elastane • regular fit • ergonomic cut • crotch insert • elasticated waistband at rear, buttoned fly • left side pocket with button fastening • folding rule pocket, as well as pen pocket on the right • back pockets • uvex logo engraved • Cradle to Cradle™ gold certified



T-shirt

men
Art. no. 88888 ■ moss green
88889 ■ light grey
88890 ■ light blue
Sizes S to 6XL

women
Art. no. 88885 ■ moss green
88886 ■ light grey
88887 ■ light blue
Sizes XS to 4XL
Material 98% cotton, 2% elastane, approx. 170 g/m²

Description: • biodegradable elastane • regular fit (men and women) • round neck (men) • submarine neckline (women) • Cradle to Cradle™ gold certified

uvex collection 26 – planet

Do something good in everyday office life!

Our business products made of 100% bio-based accessories and materials leave nothing to be desired in terms of sustainability. Natural colours and a stylish business design make them stand out.

In addition, there is a focus on resource-saving production, through reduced water use and the use of renewable energies.

75% of this collection is produced in Europe, reinforcing the "Made in uvex" protecting planet slogan for office workwear.



protecting planet

by using bio-based material



protecting planet

by using environmentally-friendly packaging



protecting planet

by saving water // by saving energy



Chinos

men

Art. no **70103** ■ graphite

Sizes S to 4XL

Material 90% organic cotton, 10% hemp, approx. 200 g/m²



Description: • straight-cut chinos made of organically grown cotton and hemp fibres, the latter has a cooling effect on the skin • with side pockets • two back piped pockets • front zip and uvex badge made from apple scraps • bamboo button • OEKO-TEX® organic cotton

Trousers

women

Art. no **70102** ■ graphite

Sizes 34 to 50

Material 90% organic cotton, 10% hemp, approx. 200 g/m²



Description: straight-cut pleated trousers made of organically grown cotton and hemp fibres, the latter has a cooling effect on the skin • with side pockets • high-cut waistband • side seam zip and uvex badge made from apple scraps • OEKO-TEX® organic cotton



Jacket

men

Art. no **70105** ■ olive

Sizes S to 4XL

women – loose fit

Art. no **70104** ■ olive

Sizes XS to 3XL

Material 86% organic cotton, 14% hemp, approx. 265 g/m²



Description: • fashionable shirt jacket in loose fit • material with a velvety soft outside made of organic cotton and hemp fibres, which have a cooling effect • front button panel with bamboo buttons • two chest pockets with flaps • two side welt pockets • two inside pockets • inside adjustment cord at waist height (for women) • uvex badge made from apple scraps • OEKO-TEX® organic cotton



Available from January 2024

Polo shirt

men

Art. no **70109** ■ beige
70110 ■ graphite

Sizes S to 4XL

women

Art. no **70107** ■ beige
70108 ■ graphite

Sizes XS to 3XL

Material 45% viscose (bamboo), 45% polylactide (maize), 10% alginate (algae), approx. 210 g/m²



Description: • sporty polo shirt with open placket fitted for women • the material is made of a new fibre mix • bamboo, maize and algae fibres provide a comfortable feel • in addition, the algae fibres are skin-friendly and moisture-regulating • bamboo fibres boast excellent moisture absorption, a soft feel and good breathability • polylactide is obtained from maize and wicks the absorbed moisture/sweat to the outside • OEKO-TEX® Standard 100



uvex

uvex collection 26

Whether indoors or outdoors –
with uvex 24/7/365 for work,
sports & leisure

uvex has been protecting people since 1926 –
at work, in sport and for leisure. Collection 26's
trendy colours and special materials effectively
blend recreational design elements with quality
work clothing features.

In any weather.
Durable. Urban.
At work and at play.



Polo shirt men

Art. no. **88360** ■ black
88361 □ white

Size S to 4XL

Material 70% cotton, 30% polyester pique, approx.
200 g/m²



Description: • casual polo shirt in a comfortable material
mix • clean loose fit • OEKO-TEX® Standard 100



Rain jacket men

Art. no. **88354** ■ saffron
Size S to 4XL

women

Art. no. **88355** ■ saffron
Size XS to 3XL
Material 100% polyester (recycled), approx. 110 g/m²



Description: • light and functional with small pack size
• waterproof zip and hood for rainy days in the city • "high-
rise" arm design • tailored (women) • breathability MVP
8,000 g/m²/24 h • 10,000 mm water column



Parka men

Art. no. **88352** ■ dark blue
88323 ■ olive
Size S to 4XL

women

Art. no. **88353** ■ dark blue
Size XS to 3XL
Material outer fabric: 100% nylon, lining and padding:
100% polyester, approx. 170 g/m²



Description: • warming, wind-resistant and water-resistant
• clean urban look • padding for optimal heat insulation
• preformed tailored fit (women) for maximum freedom of
movement • pockets with zip • breathability MVP 10,000 g/
m²/24 h • 10,000 mm water column



Functional trousers men

Art. no. **88350** ■ black
Size 42 to 64, 90 to 110

women

Art. no. **88351** ■ black
Size 34 to 50
Material 92% polyamide, 8% elastane,
approx. 178 g/m²



Description: • stylish and ultra-light • abrasion-resistant on
the outside • soft brushed on the inside • chino shape with
intelligent 3D pattern design • pockets with zip

uvex suXXeed family

One design, one fit, one range.

From head to toe, from underwear to arc protection, from recreation to protective clothing: The uvex suXXeed family's comprehensive range guarantees something for everyone. Whether you are looking for professional and protective clothing suitable for leasing or a sustainable leisure style, the uvex suXXeed collections are as extensive and flexible as the tasks for which they were created.

Flexibility and comfort are guaranteed thanks to different fit shapes and perfectly matched materials. The cuts and the 360° performance fit ensure a perfect fit and, thanks to the different models for men and women, anyone can get a feel for the extraordinary workwear up close.

Want some variety? Thanks to the selected colours and materials, all products in the collection are perfectly adapted to the most diverse requirements of workplaces. However, with well-matched items in the line, there is nothing to stop you mixing and matching and piecing together favourites yourself. Ensuring safety meets style.



uvex suXXeed

uvex suXXeed basic

uvex suXXeed craft

uvex suXXeed greencycle planet

uvex suXXeed industry

uvex suXXeed multifunction high-vis

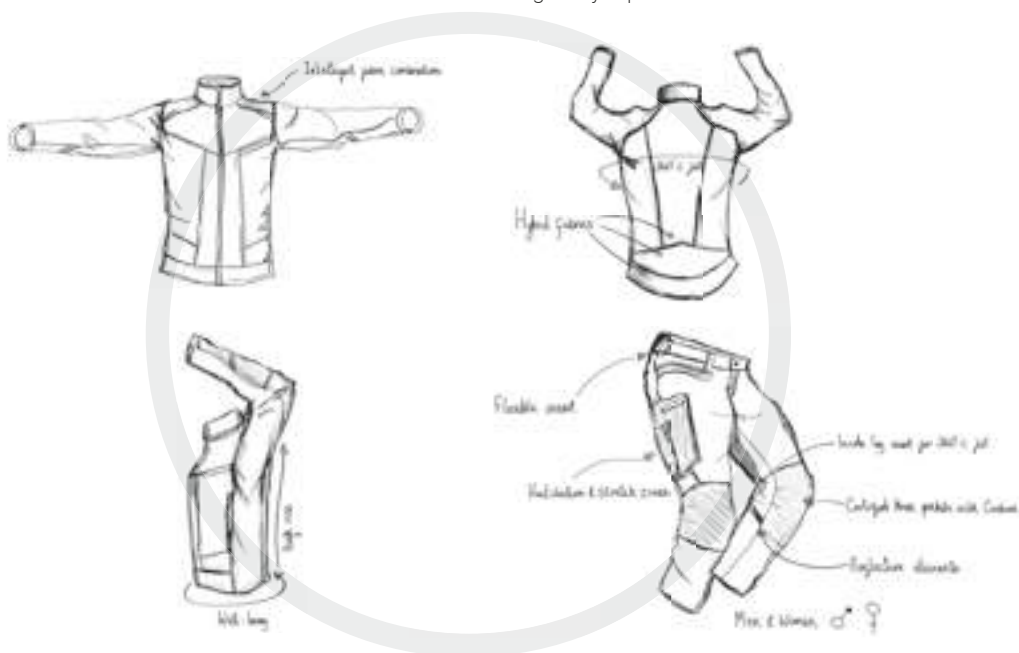

uvex suXXeed seamless underwear

uvex suXXeed construction

uvex suXXeed arc

uvex suXXeed ESD

uvex suXXeed multifunction



uvex suXXeed craft

Robust and sustainable.
In all weather conditions.

The workwear is robust and, along with special weatherproof clothing, is suitable for outdoor use. Whether you are a crafts-person or a service technician, the various pockets offer space for your tools. The four-way stretch material ensures freedom of movement and is a sustainable solution with the partly recycled polyester.



Trousers

men

- Art. no. **88766** ■ khaki
- 88767** ■ white
- 88768** ■ anthracite
- 88769** ■ graphite
- Size** 23 to 32, 42 to 66, 90 to 110

women

- Art. no. **88840** ■ white
- 88841** ■ anthracite
- 88842** ■ graphite
- Size** 19 to 26, 34 to 54
- Material** 90% polyester (recycled), 10% elastane, approx. 265 g/m²

Description: • four-way stretch material • two back and thigh pockets each reinforced with CORDURA® • integrated ruler, mobile phone and tool pocket • knee reinforcement made of CORDURA® and kneepad pockets on the inside (art. 9868900) • reflex details

Fleece jacket

men

- Art. no. **88932** ■ beige
- 88933** ■ anthracite
- 88935** ■ ultramarine
- 88936** ■ graphite
- Size** S to 6XL
- Material** 100% polyester, approx. 260 g/m²



Description: • fashionable fleece jacket with microfleece • optimal protection against wind and wet weather when combined with all-weather jacket (7321) • stand-up collar • visible front zip • two integrated side pockets • one chest pocket on the left with zip • sleeve hem with soft edging • elongated back • width-adjustable waistband • OEKO-TEX® Standard 100

women

- Art. no. **88855** ■ white
- 88857** ■ graphite
- 88856** ■ anthracite
- Size** XS to 4XL
- Material** 100% polyester (recycled), approx. 315 g/m²



Description: • fashionable fleece jacket with Sherpa fleece • stand-up collar • stretch inserts in contrasting colours • visible front zip • two integrated side pockets • elongated back • elasticated hem

All-weather jacket

- Art. no. **88741** ■ white
- 88742** ■ midnight blue
- 88743** ■ graphite
- 88744** ■ anthracite
- 89307** ■ ultramarine
- Size** S to 6XL
- Material** 100% polyester, 150 g/m²



Description: • optimal protection against wind and wet weather when combined with fleece jacket (7329) • width-adjustable, roll-up hood • width-adjustable hem and cuffs • one chest and two side pockets with zips • one inside pocket • breathability of 7000 MVP • water column of 8000 mm • OEKO-TEX® Standard 100

Softshell jacket

- Art. no. **88824** ■ khaki
- 88825** ■ white
- 88826** ■ midnight blue
- 88827** ■ graphite
- 88828** ■ anthracite
- 89308** ■ ultramarine
- Size** S to 6XL
- Material** 100% polyester, approx. 270 g/m²



Description: • width-adjustable hood • visible front zip • one chest pocket on the left with vertical opening and concealed zip • two side pockets with zip • reflex details • water column of 8000 mm • OEKO-TEX® Standard 100

Excellence without compromise

Comfortable to wear, sporty design, excellent materials, concealed closures, suitable for industrial laundering. We do not compromise with suXXeed industry. You don't have to either. With your own logo, different styles and colour combinations, you can customise your employees' work clothing.



Trousers

men

Art. no.	88324	■	ultramarine
	88325	■	anthracite
	88326	■	red
	88327	■	midnight blue
	88328	■	graphite
Size	23 to 32, 42 to 66, 90 to 110		

women

Art. no.	88594	■	ultramarine
	88595	■	anthracite
	88596	■	red
	88597	■	midnight blue
	88598	■	graphite
Size	19 to 26, 34 to 54		
Material	49% cotton, 49% polyester, 2% elastane, approx. 260 g/m ²		

Description: • two-way stretch material • 3D pattern design • elasticated waistband • two back/thigh pockets • back pockets reinforced with Cordura® • double ruler pocket made of Cordura® • mobile phone/tool pocket • all zips concealed • stretch inserts on the knees • sewn-on knee-pad pockets • reflex details • slim leg hems • OEKO-TEX® Standard 100

Long-sleeve

men

Art. no.	88636	■	ultramarine/anthracite
	88637	■	anthracite/graphite
	88638	■	red/graphite
	88639	■	midnight blue/anthracite
	88640	■	graphite/anthracite
	88641	■	light grey/anthracite
Size	S to 6XL		

women

Art. no.	88751	■	ultramarine/anthracite
	88754	■	anthracite/graphite
	88755	■	red/graphite
	88756	■	midnight blue/anthracite
	88757	■	graphite/anthracite
	88758	■	light grey/anthracite
Size	XS to 4XL		
Material	50% cotton, 50% polyester, approx. 190 g/m ²		

Description: • sporty long-sleeved shirt • accentuated side seams • optimal moisture management • excellent care/washing options • OEKO-TEX® Standard 100

T-shirt

men

Art. no.	88913	■	ultramarine/anthracite
	88914	■	anthracite/graphite
	88921	■	red/graphite
	88922	■	midnight blue/anthracite
	88923	■	graphite/anthracite
	88924	■	light grey/anthracite
Size	S to 6XL		

women

Art. no.	88906	■	ultramarine/anthracite
	88907	■	anthracite/graphite
	88908	■	red/graphite
	88909	■	midnight blue/anthracite
	88910	■	graphite/anthracite
	88911	■	light grey/anthracite
Size	XS to 4XL		
Material	50% cotton, 50% polyester, approx. 160 g/m ²		

Description: • sporty T-shirt • tailored (women) • accentuated side seams • optimal moisture management • excellent care/washing options • OEKO-TEX® Standard 100



The classic for any wearer. Women too.

Crafts and industry, regular and slim fit, women's and men's clothing – these don't have to be opposites. The uvex suXxeed collection combines the best of different worlds with its 360°-fit and casual design. Unusual material combinations and an excellent fit offer a solution for those who do not want to compromise when it comes to their work clothes.



Video



Cargo trousers

men – regular fit

Art. no. **89668** ■ midnight blue
89669 ■ graphite
 Size 23 to 32, 42 to 66, 90 to 118

women – regular fit

Art. no. **89686** ■ midnight blue
89688 ■ graphite
 Size 19 to 26, 34 to 54
 Material 65% polyester, 35% cotton, approx. 245 g/m²

Description: • flexible waistband • ventilation zones with stretch insert at the back of thighs • two back and thigh pockets each reinforced with CORDURA® • integrated folding rule, mobile phone and tool pocket • knee reinforcement made of CORDURA® (men and women) and knee pockets inside (men) for knee pads (art. 9868900) • reflex details • OEKO-TEX® Standard 100



Cargo trousers

men – slim fit

Art. no. **89659** ■ midnight blue
89665 ■ graphite
 Size 23 to 32, 42 to 66, 90 to 118

women – slim fit

Art. no. **88288** ■ midnight blue
88287 ■ graphite
 Size 19 to 26, 34 to 54
 Material 60% cotton, 20% polyester, 20% elastane, approx. 280 g/m²

Description: • casual slim-fit with additional elastic component for even greater freedom of movement • Flex waistband • ventilation zones with stretch insert at the back of thighs • two back and thigh pockets each reinforced with CORDURA® • integrated folding rule, mobile phone and tool pocket • narrow leg hems • reflex details • OEKO-TEX® Standard 100



Realworker Jacket

men

Art. no. **89466** ■ midnight blue
89467 ■ graphite
 Size S to 6XL

women

Art. no. **89474** ■ midnight blue
89653 ■ graphite
 Size XS to 4XL

Material 1. outer fabric: 95% polyester, 5% elastane, approx. 230 g/m²
 2. outer fabric: 92% polyester, 8% elastane
 3. outer fabric: 65% polyester, 35% cotton, approx. 245 g/m²



Description: • combination of robust mixed fabrics, soft-shell material and stretch inserts in the back for optimal wearing comfort • new fit with "high rise" arm construction and additional stretch for even greater freedom of movement • one breast and two side pockets for work utensils • one inner pocket on the left with hook-and-loop fastening • reflex details • OEKO-TEX® Standard 100 (art. no. 89653)

uvex suXXeed seamless underwear

Exceptional protection beneath the clothing

It's not just clothing for day-to-day working life that's important. What's beneath also matters on cold days. No side seams, but with functional zones that support each movement. Due to the regulating properties and different lengths, suitable for everyone, from skiers to construction workers.



7/8 trousers

women

Art. no. **88306** ■ black

Size XS/S to 3XL/4XL

Material 55% polypropylene, 40% lyocell, 5% elastane, approx. 200 g/m²



Description: • with TENCEL™ without irritating seams • for use at work or for leisure • suitable for yoga • quick-drying, antibacterial and odour-neutralizing • OEKO-TEX® Standard 100



Long trousers

men

Art. no. **88302** ■ black

Size S, M/L to 5XL/6XL

Material 60% polypropylene, 28% wool, 8% polyamide, 4% elastane, approx. 250 g/m²



Description: • for use at work or for leisure • without irritating seams • material mix with wool • quick-drying, odour-neutralizing, warming and moisture-regulating • intelligent zone concept for increased freedom of movement • OEKO-TEX® Standard 100



Long-sleeved shirt

men

Art. no. **88301** ■ black

Size S, M/L to 5XL/6XL

women

Art. no. **88305** ■ black

Size XS/S to 3XL/4XL

Material 60% polypropylene, 28% wool, 8% polyamide, 4% elastane, approx. 250 g/m²



Description: • without irritating seams • optimal support through intelligent material combination with wool • for use at work or for leisure • quick-drying, odour-neutralizing, warming and moisture-regulating • intelligent zone concept for increased freedom of movement • OEKO-TEX® Standard 100



uvex

uvex
perfeXXion

First colourfully mixed,
then washed clean.

If you're looking for an all-rounder, you've found it. Whether for gardening and landscaping, building management or wood processing, there is something for everyone. The durable trousers and tops of the uvex perfeXXion collection are for those looking for sturdy clothing in the usual high quality. Best of all: All individual pieces can be combined with each other and are suitable for washing.



Basic hybrid jacket

Art. no. **17222** ■ cocoa
17223 ■ pine
17224 ■ slate

Size XS to 6XL

Material 1st outer fabric: 65% polyester, 35% cotton, approx. 275 g/m²
2. outer fabric: 100% polyester, approx. 310 g/m²



Description: • smart material combination with areas made of fleece • one breast pocket on the left with vertical opening and concealed zip • two side pockets • reflex details • OEKO-TEX® Standard 100



Basic trousers

Art. no. **17194** ■ cocoa
17195 ■ pine
17196 ■ slate

Size 23 to 32, 42 to 66, 90 to 110

Material See premium trousers

Description: • very robust material due to durable yarns and special fabric structure • two patch side pockets incl. folding rule, mobile phone and tool pocket as well as pen pockets • two back pockets • retained elastic in the rear waistband • OEKO-TEX® Standard 100



EN 14404



in conjunction with kneepads (art. no. 9868900)

Type 2 - Level 1

Bermuda premium

Art. no. **17200** ■ cocoa
17201 ■ pine
17202 ■ slate

Size 42 to 66

Material See premium trousers

Description: • very robust material due to durable yarns and special fabric structure • two multifunctional back and thigh pockets incl. folding rule, mobile phone and tool pockets as well as pen pockets and hammer loop • two back pockets • retained elastic in the rear waistband • OEKO-TEX® Standard 100

Premium trousers

With knee pockets

Art. no. **17191** ■ cocoa
17192 ■ pine
17193 ■ slate

Size 23 to 32, 42 to 66, 90 to 110

Material 65% polyester, 35% cotton, approx. 290 g/m²







Description: See also Bermuda premium • concealed stretch insert at the knee and patch knee pockets made of CORDURA® • knee pad (art. 9868900) • reflex details • OEKO-TEX® Standard 100

uvex suXXeed arc

uvex suXXeed multifunction

For those working on live components

The suXXeed arc and suXXeed multifunction collections are based on the highest safety standards for heavy duty and dangerous work. In addition to protection against heat and flames, they offer extended protection against arcing. This makes the collections ideal for working on electrically charged components with perfect fitting when performing any movement thanks to 3D cutting guide.





 EN ISO 11611 Class 1-A1	 EN ISO 11612 A1, B1, C1, F1	 IEC 61482-2 APC=1 APC=2 (front and sleeve only)	 EN 1149-5
---	---	---	--

IEC 61482-2 APC 2 (7 ka)
IEC 61482-2 APC 2 in the double-layered areas of the jacket and trousers (front and sleeves)

IEC 61482-1-1 ATPV
in the double-layered areas of the jacket and trousers (front and sleeves) = 46 cal/cm²
in the double-layered areas of the jacket (front and sleeves) in combination with shirt 7937 = 62 cal/cm²
in the double-layered areas of the jacket (front and sleeves) in combination with shirt 7421 = 57 cal/cm²

Successful test with increased arc energy of (558.7-564.8) kJ for double-layered jacket with shirt model 7937 in accordance with EN 61482-1-2 at 11.78 kA/0.5 s (tested at Eurotest)



 EN ISO 11611 Class 1-A1	 EN ISO 11612 A1, B1, C1, E2, F1	 IEC 61482-2 APC-1	 EN 1149-5	 EN 13034 Type 6
---	---	---	--	---



Jacket

uvex suXXeed arc

Art. no. **88492** ■ graphite

Size S to 6XL

Material outer fabric: 50% cotton, 49% polyester, 1% antistatic fibre, 345 g/m²
lining: 88% cotton, 12% polyamide, 200 g/m²



Description: • multifunctional and for the highest protection requirements • ergonomic cutting guide • double-layer construction in the front area and sleeves • integrated stretch zones for greater freedom of movement under the arms and in the back • "high-rise" sleeve construction • flame-retardant reflex strips • orange coloured pictograms for quick differentiation of protection classes • maximum protection in combination with long-sleeved shirt or poloshirt (89312, 89409, 89798)

Trousers

uvex suXXeed arc

Art. no. **88493** ■ graphite

Size 42 to 66, 90 to 110, 23 to 32

Material see jacket

Description: • for maximum protection requirements in hazardous environments • particularly soft and skin-friendly wearing comfort • double-layer construction in the front area • crotch insert for maximum freedom of movement • two leg and side pockets • with inner knee pockets • flame-retardant reflex strips • orange coloured pictograms for differentiation

Dungarees

uvex suXXeed arc

Art. no. **88494** ■ graphite

Size 42 to 66, 90 to 110, 23 to 32

Material see jacket

Description: • maximum protection when working in extreme conditions • particularly soft and skin-friendly wearing comfort • double-layer construction in the front area • integrated stretch zones on the sides for greater freedom of movement • flame-retardant reflex strips • orange coloured pictograms for differentiation

Jacket

uvex suXXeed multifunction

Art. no. **88281** ■ midnight blue

88282 ■ graphite

Size S to 6XL

Material 49% modacrylic, 42% cotton, 5% aramid, 3% polyamide, 1% antistatic fibres, approx. 300 g/m²



Description: • uvex suXXeed design is multifunctional and suitable for the toughest protection requirements • flame-retardant fabric and the use of para-aramid and polyester fibres ensure high durability and multifunctional protection against molten iron E2 • particularly soft and very comfortable to wear • integrated stretch fabric panels for more freedom of movement • high-rise sleeve design • flame-retardant reflective stripes

Trousers

uvex suXXeed multifunction

Art. no. **88283** ■ midnight blue

88284 ■ graphite

Size 23 to 32, 42 to 66, 90 to 110

Material see jacket

Description: • suitable for the highest protection requirements in hazardous areas, in uvex suXXeed design • inside knee pockets for knee pads • flame-retardant reflective strips

Dungarees

uvex suXXeed multifunction

Art. no. **88285** ■ midnight blue

88286 ■ graphite

Size 23 to 32, 42 to 66, 90 to 110

Material see jacket

Description: • maximum protection when working in extreme conditions • in uvex suXXeed design • integrated stretch zones for greater freedom of movement • inside knee pockets for knee pads • flame-retardant reflective strips



uvex

uvex protection perfect multifunction

PPE with everything you need.

Whether it's chemicals, arcing, heat, flames, metal splashes or everything at once, uvex protection perfect multifunction has all industrial dangers covered. To describe the collection as all-rounders would be an understatement – with their stretch inserts, the garments move with the body, protecting everything.



- EN ISO 11611**

 Class 1-A1
- EN 1149-5**

 A1, B1, C1, E2, F1
- EN ISO 11612**

 A1, B1, C1, E2, F1
- IEC 61482-2**

 APC= 1
- EN 13034**

 Type 6



Jacket

- Art. no.** 17241 ■ cornflower blue
 17242 ■ dark grey
- Size** 40/42 to 64/66, 90/94 to 106/110
- Material** 49% modacrylic, 42% cotton, 5% aramid, 3% polyamide, 1% antistatic fibres, approx. 300 g/m²
- INDUSTRIALWASH●●

Description: • Front panel with concealed zip and rip-tape fastening • chest, napoleon and side pockets with closure • flame-retardant fabric • flame-retardant reflective strips • stretch inserts in the back shoulder area • width-adjustable sleeve hem with rip-tape fastening • thanks to high cotton content, particularly soft and skin-friendly comfort

Trousers

- Art. no.** 17245 ■ cornflower blue
 17246 ■ dark grey
- Size** 42 to 64, 90 to 110
- Material** 49% modacrylic, 42% cotton, 5% aramid, 3% polyamide, 1% antistatic fibres, approx. 300 g/m²
- INDUSTRIALWASH●●

Description: • Leg, back and folding rule pocket with closure option • stretch zones on the knee externally for greater freedom of movement • flame-retardant fabric • flame-retardant reflective strips • inside knee pockets for knee pads • thanks to high cotton content, particularly soft and skin-friendly comfort

Dungarees

- Art. no.** 17251 ■ cornflower blue
 17252 ■ dark grey
- Size** 40/42 to 64/66, 90/94 to 106/110
- Material** See trousers
- Description:** • Bib, leg, back and folding rule pocket with closure • stretch zones on the knee externally for greater freedom of movement • flame-retardant fabric • flame-retardant reflective strips • inside knee pockets for knee pads

► **Note:** This protective clothing must always be worn as a suit in combination with jacket and trousers or dungarees.

uvex suXXeed construction

Full body sun protection for all outdoor workers

On construction sites, many hidden dangers lurk. Not just obvious injury hazards, but sunburn and skin cancer. That's why we've included UV protection in the uvex suXXeed construction collection. In addition to sun protection, the line offers a perfect fit thanks to its 3D fit and is partly made of sustainable materials.



EN ISO 20471 EN ISO 20471



Size S - M



Size L - 6XL



Polo shirt

short-sleeved

Art. no. **88279** ■ signal orange
88280 ■ signal yellow

Size S to 6XL
 Material 50% polyester, 50% cotton, approx. 180 g/m²

long-sleeved

Art. no. **88277** ■ signal orange
88278 ■ signal yellow

Size S to 6XL
 Material 50% polyester, 50% cotton, approx. 180 g/m²

Description: • polo collar with button panel • 50% recycled polyester • reflective strips all around • tested according to DIN EN 13758-1 with UPF 30 (classified according to AS/NZS 4399) • long-sleeve from size L onwards; additionally BG Bau eligible • OEKO-TEX® Standard 100



EN ISO 20471



EN ISO 20471



Waist jacket

Art. no. **88265** ■ signal orange
88266 ■ signal yellow

Size XS bis 4XL
 Material 50% cotton, 50% polyester, approx. 270 g/m²

Description: • high-rise arm design • 3D cut guide • two side pockets • front centre zip • two inner pockets • reflective tape • UV protection certified according to UV standard 801 with UPF 80 • OEKO-TEX® Standard 100

Trousers

Art. no. **88267** ■ signal orange
88268 ■ signal yellow

Size 23 to 32, 42 to 66, 90 to 110
 Material 50% cotton, 50% polyester, approx. 270 g/m²

Description: • crotch insert for greater freedom of movement • stretch waistband with patent button • inside leg pocket • left and right side pocket with flap and press stud fastening • UV protection certified according to UV Standard 801 with UPF 80 • OEKO-TEX® Standard 100



uvex protection active flash

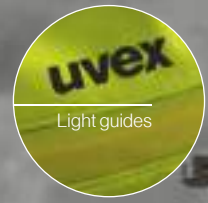

See and be seen

Reflective strips are a must in darkness and poor visibility. We've raised the bar and have installed an innovative fibre optic system that actively lights up. Thus, you can be easily seen even without an external light source. It goes without saying that the collection fits perfectly.



EN ISO 20471



Vest
with switch

Art. no. 17322 ■ signal yellow/signal orange
Size M to 3XL
Material 65% polyester, 35% cotton, approx. 245 g/m²

Description: • active protection thanks to horizontal and vertical light guide system • hook-and-loop fastening to quickly fasten the vest • with switch for various light modes



EN ISO 20471



Vest
with switch

Art. no. 17323 ■ signal yellow
Size M to 3XL
Material 100% polyester, mesh

Description: • active protection thanks to vertical light guide system • hook-and-loop fastening to quickly fasten the vest • with switch for various light modes

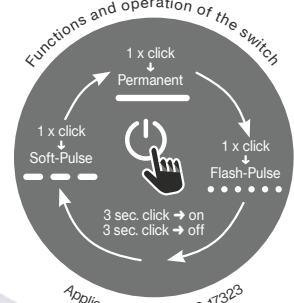

Battery pack
for models with switch

Art. no. 173320 white

Description: • portable external battery for art. no. 17322, 17323 • dimensions: 93 x 58 x 12 mm, approx. 83 g



uvex

uvex cut quatreflex

Protects when work gets sharp

Glass fibre is not just good for fast internet. In the uvex cut collection, the cut-resistant fibre provides maximum protection against sharp edges, glass and are blades. Inside, the clothes are lined with bamboo yarn and are pleasantly soft. This collection is therefore robust and comfortable at the same time, even after multiple industrial cleans.

The knitted cut protection fabric protects against superficial mechanical injuries and achieves performance level D according to EN 388:2019, tested according to ISO 13977:1999.



Trousers with functional fabric

Art. no. **17865** ■ black

Size 23 to 32, 42 to 64, 90 to 110

Material 1st material: 65% polyethylene, 35% polyester
2nd material: 65% polyester, 35% cotton, approx. 245 g/m²



Description: • high content of cut-protection fabric on the front leg and calf for optimal protection against superficial, mechanical injuries • achieves cut level C • sporty fit • two slant pockets • two back pockets • one ruler pocket including pen pocket on the left thigh • concealed waist button

uvex cut quatreflex trousers

Art. no. **17270** ■ black/anthracite (front side of trouser legs)

Size 42 to 64, 90 to 110

Material 1st material: 65% polyester, 35% cotton, approx. 245 g/m²
2nd material: 42% polyamide, 22% polyethylene, 22% viscose, 12% fibreglass, 2% elastane



Description: • casual cut • functional, highly elastic strip in the knee area • integrated inserts to allow crosswise stretch along the side seam • waistband elasticated at the back • two back pockets • protection and wearer comfort guaranteed even after repeated washing • cut protection material: extremely durable on the outside, pleasantly cool on the inside



uvex cut quatreflex t-shirt

Art. no. **17268** ■ black/anthracite (sleeves)

Size S to 3XL

Material 1st material: 50% cotton, 50% polyester, approx. 160 g/m²
2nd material: 42% polyamide, 22% polyethylene, 22% viscose, 12% fibreglass, 2% elastane



Description: • slim fit made from single-jersey fabric with cut-protection sleeves of the highest cut protection class • functional, highly elastic strip in the elbow area • integrated cuffs on sleeves without irritating seams • protection and wearer comfort guaranteed even after repeated washing • cut protection material: extremely durable on the outside, pleasantly cool on the inside



uvex cut quatreflex polo shirt

Art. no. **17266** ■ black/anthracite (sleeves)

Size S to 3XL

Material 1st material: 55% cotton, 45% polyester, approx. 185 g/m²
2nd material: 42% polyamide, 22% polyethylene, 22% viscose, 12% fibreglass, 2% elastane



Description: see below

Art. no. **17267** ■ black/anthracite (sleeves)

Size S to 3XL

Material 1st material: 54% modacrylic, 44% cotton, 2% antistatic fibres, approx. 195 g/m²
2nd material: 42% polyamide, 22% polyethylene, 22% viscose, 12% fibreglass, 2% elastane



Description: • slim fit • sleeves made from cut-resistant material of the highest cut protection class combined with heat-resistant body material made from breathable functional fibres • panel with three buttons • functional, highly elastic strip in the elbow area • integrated cuffs on sleeves without irritating seams • protection and wearer comfort guaranteed even after repeated washing • cut protection material: extremely durable on the outside, pleasantly cool on the inside



uvex suXXeed ESD

Exceptional protection for man and machine

The uvex suXXeed ESD collection prevents electrostatic discharge of the wearer or wearer to a machine. This protects sensitive electronic components. With the usual 3D fit and high-rise arm construction, perfect fitting is always ensured, both in women's and men's versions. By the way, ESD means electrostatic discharge.



Seamless shirt

men

Art. no. **88264** ■ black
Size XS/S to 3XL/4XL

women

Art. no. **88264** ■ black
Size XS, S/M to XXL/3XL, 4XL
Material 91% polypropylene, 7% polyamide, 2% silver

Description: • ESD suitable with antistatic fibres • quick-drying, antibacterial, odour-neutralising using innovative Dryarn® fibre • seamless processing for full well-being • OEKO-TEX® Standard 100



Trousers

Art. no. **88263** ■ graphite
Size 23 to 32, 42 to 66, 90 to 110
Material 66.5% polyester, 32% cotton, 1.5% anti-static fibres, approx. 245 g/m²

Description: • maximum protection with antistatic fibres for optimal charge reduction and conductivity • crotch insert for greater freedom of movement • stretch waistband with patent button • left side pocket with flap and press stud fastening • OEKO-TEX® Standard 100



Coat

Art. no. **88260** □ white
88261 ■ graphite
Size S to 6XL
Material 66.5% polyester, 32% cotton, 1.5% anti-static fibres, approx. 245 g/m²

Description: • with anti-static fibres for optimal charge reduction and conductivity • ergonomic 3D cutting guide • "high rise" arm design • breast pocket on the left, two side pockets • stand-up collar • OEKO-TEX® Standard 100

OEKO-TEX® Standard 100 Certificates Sustainability



Textiles tested in accordance with the criteria of OEKO-TEX® Standard 100 ensure that no amount of substances are present that affect human health. Only products that meet the very strict requirements and undergo ongoing checks are awarded OEKO-TEX® certification. Products are shown below.



S20-0516
Hohenstein HTTI

S20-0516 HOHENSTEIN HTTI applicable to the following items:

17191, 17192, 17193, 17193, 17194, 17195, 17196, 17222, 17223, 17224, 17200, 17201, 17202, 70107, 70108, 70109, 70110, 88260, 88261, 88263, 88264, 88264, 88265, 88266, 88267, 88268, 88277, 88278, 88279, 88280, 88287, 88288, 88301, 88302, 88305, 88306, 88360, 88361, 88324, 88325, 88326, 88327, 88328, 88594, 88595, 88596, 88597, 88598, 88636, 88637, 88638, 88639, 88640, 88641, 88741, 88742, 88743, 88744, 88751, 88754, 88755, 88756, 88757, 88758, 88824, 88825, 88826, 88827, 88828, 88906, 88907, 88908, 88909, 88910, 88911, 88913, 88914, 88921, 88922, 88923, 88924, 88932, 88933, 88935 88936, 89307, 89308, 89653, 89659, 89665, 89668, 89669, 89686, 89688

OEKO-TEX® ORGANIC COTTON
In certification:
applicable to the following items:
70102, 70103, 70104, 70105



Manufacturing expertise

Designed and made in Europe for consistent quality



amfori BSCI

Verantwortung für bessere soziale Nachhaltigkeit



uvex hazardous substances list

List of banned hazardous substances — compliance is ensured by regular monitoring from independent test institutes



DIN EN ISO 9001

Quality thanks to optimised work processes

www.tuev-sued.de/ms-zert

Detailed information on the award criteria of the OEKO-TEX® certificate issuers can be found at: www.uvex-safety.com/en/knowledge/certificates/



S20-0516
Hohenstein HTTI

OEKO-TEX Standard 100

Comprehensive avoidance of substances harmful to health



GLS — KlimaProtect

Climate-neutral parcel delivery thanks to CO₂ offsetting



Benefit from our knowledge



The uvex academy provides qualified education and training in the fields of personal protective equipment (PPE) and health and safety at work.

- All uvex academy training sessions are offered in-house or as company seminars
- Seminars in accordance with your individual specifications can be developed on request



You can find more information at uvex-academy.com



uvex



Outstanding innovations and designs

The uvex brand has an outstanding reputation worldwide. Perfection, innovation and excellent quality – we want to offer our customers nothing less with our products. We receive confirmation from renowned institutes in the form of awards and prizes, letting us know that we have struck the right chord and are on the right track.



Safety helmet
uvex pronamic alpine



Safety eyewear
uvex pure-fit



Safety footwear
uvex 3

reddot winner 2022

Prestigious design awards, including the **red dot design award**, the **iF product design award** and the **Plus X Award** confirm that uvex products meet the highest demands for functionality while still looking good.

Safety eyewear
uvex i-range

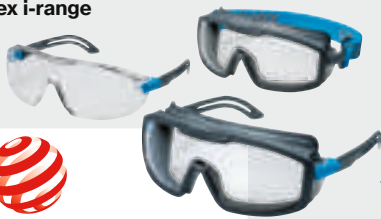

reddot winner 2022



Safety eyewear
uvex suXxeed

Awards for all uvex product divisions

2020
Highest customer satisfaction:
uvex safety eyewear



2020/2021
Most innovative company
in Germany:
UVEX SAFETY Gloves GmbH & Co. KG

EUROPE

UVEX ARBEITSSCHUTZ GMBH

Würzburger Straße 181-189
90766 Fürth
GERMANY

T: 0800 6644893
F: 0800 6644894
E: serviceteam@uvex.de
I: uvex-safety.de

UVEX SAFETY Textiles GmbH

Robert-Schumann-Straße 33
08236 Ellefeld
GERMANY

T: +49 3745 740-0
F: +49 3745 740-100
E: corporatefashion@uvex.de
I: uvex-safety.de

UVEX SAFETY Gloves GmbH & Co. KG

Elso-Klöver-Straße 6
21337 Lüneburg
Postfach 24 47 · 21314 Lüneburg
GERMANY

T: +49 4131 9502-0
F: +49 4131 84338
E: gloves@uvex.de
I: uvex-safety.de

UVEX SAFETY Austria GmbH

Pfarrgasse 25
4600 Wels
AUSTRIA

T: +43 7242 210 745
F: +43 7242 210 745-28
E: safety@uvex.at
I: uvex-safety.at

UVEX Arbeitsschutz (Schweiz) AG

Uferstrasse 90 - postbox
4019 Basel
SWITZERLAND

T: +41 61 638 84 44
E: info@uvex.ch
I: uvex-safety.ch
I: heckel-safety.ch

UVEX HECKEL s.a.s.

44 rue d'Engwiller
La Walck
67350 Val de Moder
FRANCE

T: +33 3 88 07 61 08
F: +33 3 88 72 51 06
E: contact.france@uvex-heckel.fr
I: uvex-heckel.fr

UVEX SAFETY (UK) LTD

uvex House
Farnham Trading Estate
Farnham
Surrey
GU9 9NW
UNITED KINGDOM

T: +44 1252 73 12 00
E: safety@uvex.co.uk
I: uvex-safety.co.uk

UVEX Safety Italia S.R.L.

Corso Grosseto 437
10151 Torino
ITALY

T: +39 011 4536511
F: +39 011 7399522
E: info@uvex-safety.it
I: uvex-safety.it

UVEX Safety Scandinavia AB

Pumpvägen 4
24393 Höör
SWEDEN

T: +45 75661612
M: +45 21466656
E: nordic@uvex.de
I: uvex-safety.se

UVEX SAFETY Polska sp. z o.o. sp.k.

Większyce, ul. Głogowska 3A
47-208 Reńska Wieś
POLAND

T: +48 77 482 62 58
F: +48 77 482 62 57
E: uvex@uvex-integra.pl
I: uvex-safety.pl

UVEX Safety CZ, k.s.

Na Jamách 394
47-01 Rychnov nad Kněžnou
CZECH REPUBLIC

T: +420 494 531 331
F: +420 494 533 395
E: info@uvex.cz
I: uvex-safety.cz

UVEX Safety SK k.s.

Jesenná 1
080 05 Prešov
SLOVAKIA

T: +421 517 732 138
M: +421 918 964 591
E: uvex@uvex-safety.sk
I: uvex-safety.sk

UVEX Safety Hungaria Bt.

Terstyánszky u. 23.
2083 Solymár
HUNGARY

T: +36 26 560093
M: +36 30 4773135
E: e.boros@uvex.de
I: uvex-safety.hu

ASIA · PACIFIC · AUSTRALIA

UVEX (GUANGZHOU) SAFETY CO. LTD

No. 3, Building ShenLan Industrial Zone
ShiBei Avenue Dashi Panyu
Guangzhou Guangdong
CHINA 511430

T: +86 20 3479 2338
F: +86 20 3479 1098
E: info@uvex.com.cn
I: uvex.com.cn

UVEX SAFETY SINGAPORE PTE LTD

25 International Business Park Rd,
#03-112/113, German Centre
SINGAPORE 609916

T: +65 6162 8138
E: sales@uvexsafety.com.sg
I: uvex-safety.com.sg

UVEX SAFETY AUSTRALIA LIMITED PARTNERSHIP

Unit 3 Riverside Centre
24-28 River Road West
Parramatta NSW 2150
AUSTRALIA

T: +61 2 9891 1700
F: +61 2 9891 1788
E: info@uvex.com.au
I: uvex-safety.com.au

For Indonesia:

UVEX SAFETY SINGAPORE PTE LTD

Representative Office Indonesia
Pondok Indah Office Tower 3, 17th Floor
Jl. Sultan Iskandar Muda, Kav. V-TA
Pondok Indah, Jakarta 12310
INDONESIA

T: +6221 2953 8910
E: sales@uvex-safety.com.sg
I: uvex-safety.co.id/id

For Malaysia:

UVEX SAFETY SINGAPORE PTE LTD

Representative Office Malaysia
Regional Office Malaysia
1 Sentral, Level 16,
Jalan Stesen Sentral 5,
KL Sentral, Kuala Lumpur 50470
MALAYSIA

T: +603 2092 9261
E: sales@uvex-safety.com.sg
I: uvex-safety.com.my

Sydney 1800 815 790
Melbourne +61 3 9832 0851
Brisbane +61 7 3394 8414
Adelaide +61 8 8376 0732
Perth +61 8 9209 1444

UVEX Safety New Zealand Pty Ltd

T: +64 800 698 839
E: info@uvex.co.nz
I: uvex-safety.co.nz

AFRICA · MIDDLE EAST AND INDIA

uvex safety South Africa (Pty) Ltd

2 Kubu Avenue,
Riverhorse Valley,
Effingham, Durban, 4051
SOUTH AFRICA

T: +27 31 569 67 80
E: info@uvex.co.za
I: uvex.co.za

UVEX ARBEITSSCHUTZ GMBH

Dubai Office
B6-606
HQ Building
Dubai Silicon Oasis
Dubai
UAE

Middle East & India:
T: +971 4 372 4753
E: sales@uvex.co.za
I: uvex-safety.ae/en/

uvex Safety Eyewear		13
Coating technology	20	Infrared protection 66
Labelling and norms	23	Welding protection 68
Lens tinting	24	Accessories 71
Safety spectacles	28	Cord/case mix 74
Overspecs	55	Applications 75
Safety goggles	58	Safety eyewear – Overview 76
uvex Hearing Protection		79
All ears when it comes to safety	82	Banded ear protection 96
Size, fit and uvex xact-fit test	84	uvex earmuff range 97
Disposable hearing protection plugs	86	Helmet earmuffs 104
Reusable ear plugs	92	Accessories 110
Detectable	94	Hearing protection – Overview 112
uvex Safety Helmets		113
Standards at a glance	116	Visors and face protection 142
Safety helmets	118	Face protection system 150
Accessories	132	Impact caps 153
Head torchs	135	Safety helmets – Overview 157
Visor lenses, certification and norms	140	
uvex Breathing Protection		159
Respirator advisor	164	Respirators uvex silv-Air e 171
The uvex breathing protection navigator	165	Respirators uvex silv-Air c 174
Applications	166	uvex medical face mask 179
Combination options with uvex safety eyewear	167	Pictograms – Functions 180
Respirators uvex silv-Air premium	168	Breathing protection – Overview 181
uvex Disposable Coveralls		183
Guide to standards and products	184	Accessories 193
Disposable coverall type 3B	186	Protection against infectious diseases 194
Disposable coverall type 4B	189	Chemicals database 195
Disposable coveralls type Typ 5/6	190	Guidelines for use 196
uvex Safety Gloves		197
Standards	208	Chemical risks 249
in the food industry	208	Disposable safety gloves 258
Mechanical risks	212	Hexarmor® safety gloves 260
uvex glove expert	248	Safety gloves – Overview 275
uvex Safety Footwear		277
Areas of application	284	Safety footwear medium areas of application 324
uvex multiple width system	285	Safety footwear heavy areas of application 339
Technologies	286	Heckel safety shoes 348
Pictogram overview	288	Accessories: inlay soles 354
Standards and labels, ESD	292	Safety footwear – Overview 358
Safety footwear light areas of application	294	
uvex Individual PPE		361
Prescription safety eyewear	367	IndividueTailor-made hearing protection uvex high-fit 413
VDU spectacles	404	Orthopedic foot protection uvex medicare 427
uvex Workwear		439
uvex suXXeed greencycle planet collection	444	uvex suXXeed arc collection 453
uvex collection 26 planet	445	uvex suXXeed multifunction collection 453
uvex suXXeed craft collection	448	uvex protection perfect multifunction collection 454
uvex suXXeed industry collection	449	uvex suXXeed construction collection 455
uvex suXXeed collection	450	uvex protection active flash collection 456
uvex suXXeed seamless underwear collection	451	uvex cut collection 457
uvex perfeXXion collection	452	uvex suXXeed ESD collection 458

made2perform



English Version

protecting planet

uvex uses environmentally friendly Steinbeis recycled paper in the production of this catalogue. Compared to fresh-fibre paper, this means a significant amount of resources can be saved during the catalogue's print run:



Wood
107.700 kg



Water
2.002.044 l



Energy
474.290 kWh



CO₂ emissions
20.074 kg

UVEX ARBEITSSCHUTZ GMBH
Wuerzburger Straße 181-189
90766 Fuerth
GERMANY

T: +49 911 9736-0
F: +49 911 9736-1760
E: safety@uvex.de
I: uvex-safety.com



Carbon neutral

Print product
ClimatePartner.com/11586-2308-1004

The print is certified as climate-neutral.