



**uvex**

# Safety Helmets

---

protecting people

# Standards at a glance

EN 397 · EN 50365

## EN 397 – Industrial safety helmets

Protection against falling objects and the consequences thereof, such as brain damage and skull fracture

**Binding requirements:** all helmets certified according to EN 397 must meet these requirements.

- shock absorption, vertical
- penetration resistance (against sharp and pointed objects)
- flame resistance
- chin strap attachment: chin strap releases at minimum 150 N and maximum 250 N

**Optional requirements:** a helmet certified in accordance with EN 397 may meet these requirements; they are, however, not mandatory requirements.

- very low temperatures (-20°C or -30°C)
- very high temperatures (+150°C)
- electrical insulation (440 V)
- molten metal (MM)
- lateral deformation

very low temperatures (-20°C or -30°C)	 uvex airwing	 uvex super boss	 uvex pheos	 uvex pheos alpine	
very high temperatures (+150°C)					 uvex thermo boss
electrical insulation (440 V)		 uvex airwing E			 uvex thermo boss
molten metal (MM)			 uvex pheos		
lateral deformation					

## EN 50365 – Insulating helmets for use on low voltage installations

Protection against electric shocks and prevention of dangerous electric current passing through the head

**Requirements:**

- All helmets must also meet the requirements in accordance with EN 397.
- Protection against alternating voltage of up to 1000 V (AC) or direct voltage up to 1500 V (DC)
- Insulating helmets must not contain any conductive parts.
- Air vents (if available) must not allow any accidental contact with live parts.



uvex pheos E

# Overview of standards

EN 12492

## EN 12492 – Helmets for mountaineers

Protection against hazards that may occur during activities undertaken by mountaineers

### Requirements:

- Shock absorption, vertical, frontal, lateral, dorsal
- Penetration resistance
- Carrier element (chin strap releases at min. 500 N)
- Strength of carrier element: Chin strap may exhibit maximum elongation of 25 mm
- Carrier element effectiveness: Helmet must not slide from the head



uvex pheos alpine



# Forestry worker set

Specially developed to meet the needs of forestry workers



## Perfect 'resting position' for the visor and hearing protection

Based on the uvex pheos visor system, the visor can be locked above the helmet shell when not required and the hearing protection can be folded back. Everything fits closely to the helmet and is perfectly balanced over the body's centre of gravity. This means the neck muscles are not placed under strain by any unnecessary weight, ensuring excellent wearer comfort and maximum freedom of movement. So hitting or getting caught on overhead branches is now a thing of the past. Plus, your view is not restricted by the visor when in the resting position (visor open) either.



## Perfect helmet climate:

Three variable air vents ensure maximum ventilation. In cold weather, the vents can easily be closed from the outside using sliders. Ventilation in the direction of movement ensures optimum air flow.



Emergency whistle included in uvex pheos forestry set



## Wide range of accessories

The set comes as standard with a four-point chin strap and signal whistle. In the event of an emergency, the signal whistle makes it possible to emit a sustained rescue or warning signal over two frequencies and is significantly louder than the human voice: extremely loud for maximum range. Made from a single piece without moving parts to reliably ensure long-term functionality. Clipped into the helmet and therefore always at hand in an emergency. Alternatively, the whistle can be attached to a key ring or a cord.

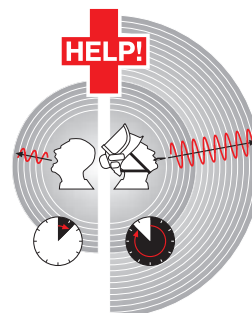

## High wearer comfort

Thanks to soft sweatband and wheel ratchet padding.

# Safety Helmets

uvex pheos forestry · uvex pheos ABS



Further information can be found at [uvex-safety.com/en/forestryset](http://uvex-safety.com/en/forestryset) (or scan the QR code).



## uvex pheos forestry

- set specially developed to meet the needs of forestry workers, consisting of the uvex pheos ABS B-S-WR, uvex pheos forestry visor and uvex pheos K2P mechanical
- labelled with label set, including pre-attached chin strap and signal whistle
- meets standards EN 166, 1731, 352-1 and 397 and additional requirement for very low temperatures (-30 °C)
- fully integrated metal mesh visor with high transmission (transparency) protects against foreign objects and ensures a clear view
- high-insulation earmuffs (SNR: 30 dB) round off the system perfectly and reliably protect against noise produced by chainsaws and brush cutters
- three variable air vents for maximum ventilation, offering ventilation in the direction of movement
- suspension harness with wheel ratchet system enables the width to be variably adjusted with just one hand

uvex pheos forestry - pre-assembled set			
Art. no.	9774236	9774237	9774238
Colour	yellow	orange	red
Version	with short brim	with short brim	with short brim
Material	ABS	ABS	ABS
Standard	EN 397, -30 °C, MM	EN 397, -30 °C, MM	EN 397, -30 °C, MM
	EN 1731:2006-F	EN 1731:2006-F	EN 1731:2006-F
	EN 352-3	EN 352-3	EN 352-3
Sizes	52 to 61 cm	52 to 61 cm	52 to 61 cm
Order unit	PC	PC	PC
Outer packaging	15 PC per CT	15 PC per CT	15 PC per CT

uvex pheos forestry - spare parts		
Art. no.		Order unit
9790210	Replacement visor (metal)	PC
2600214	uvex K2P mechanical	PC
9760106	Replacement suspension harness pheos ABS	PC
9760009	Sweatband pheos ABS	PC
9790021	Four-point chin strap	PC
9790146	Signal whistle	PC



MADE IN GERMANY



## uvex pheos ABS

- ABS safety helmet with slots for uvex visors, earmuffs and helmet lamps
- side Euroslot adapters (30 mm) for attaching earmuffs
- meets EN 397 standards and additional requirements for very low temperatures (-30°C)
- high lateral rigidity
- three variable air vents for maximum ventilation
- conventional suspension harness for comfortable adjustable fit (uvex pheos B)
- suspension harness fitted with wheel ratchet system (9760012) and sweatband (9760009)
- six-point textile band attachment ensures optimum fit and comfort

uvex pheos ABS B-S-WR with wheel ratchet system				
Art. no.	9772071	9772171	9772271	9772371
Colour	white	yellow	orange	red
Version	with short brim	with short brim	with short brim	with short brim
Material	ABS	ABS	ABS	ABS
Standard	EN 397	EN 397	EN 397	EN 397
	-30 °C, MM	-30 °C, MM	-30 °C, MM	-30 °C, MM
Sizes	52 to 61 cm	52 to 61 cm	52 to 61 cm	52 to 61 cm
Order unit	PC	PC	PC	PC
Outer packaging	24 PC per CT	24 PC per CT	24 PC per CT	24 PC per CT

# Safety Helmets

uvex airwing B · uvex airwing B-WR · uvex super boss



## uvex airwing B · uvex airwing B-WR

- safety helmet with slots for uvex visors and earmuffs
- side Euroslot adapters (30 mm) for attaching earmuffs
- meets standard EN 397 and additional requirement for very low temperatures (-30 °C)
- three variable air vents for maximum ventilation
- conventional suspension harness for comfortable adjustable fit (uvex airwing B)
- suspension harness with wheel ratchet for variable width adjustment (uvex airwing B-WR)
- fitted with the 9760005 sweatband
- six-point textile band attachment ensures optimal fit and comfort

uvex airwing B with conventional suspension harness							
Art. no.	9762020	9762120	9762220	9762320	9762420	9762520	9762920
Colour	white	yellow	orange	red	green	blue	black
Version	with long brim	with long brim	with long brim	with long brim	with long brim	with long brim	with long brim
Material	HDPE	HDPE	HDPE	HDPE	HDPE	HDPE	HDPE
Standard	EN 397, -30 °C	EN 397, -30 °C	EN 397, -30 °C	EN 397, -30 °C	EN 397, -30 °C	EN 397, -30 °C	EN 397, -30 °C
Sizes	51 to 61 cm	51 to 61 cm	51 to 61 cm	51 to 61 cm	51 to 61 cm	51 to 61 cm	51 to 61 cm
Order unit	PC	PC	PC	PC	PC	PC	PC
Outer packaging	25 PC per CT	25 PC per CT	25 PC per CT	25 PC per CT	25 PC per CT	25 PC per CT	25 PC per CT

uvex airwing B-WR with wheel ratchet system						
Art. no.	9762030	9762130	9762230	9762330	9762430	9762530
Colour	white	yellow	orange	red	green	blue
Version	with long brim	with long brim	with long brim	with long brim	with long brim	with long brim
Material	HDPE	HDPE	HDPE	HDPE	HDPE	HDPE
Standard	EN 397, -30 °C	EN 397, -30 °C	EN 397, -30 °C	EN 397, -30 °C	EN 397, -30 °C	EN 397, -30 °C
Sizes	52 to 61 cm	52 to 61 cm	52 to 61 cm	52 to 61 cm	52 to 61 cm	52 to 61 cm
Order unit	PC	PC	PC	PC	PC	PC
Outer packaging	25 PC per CT	25 PC per CT	25 PC per CT	25 PC per CT	25 PC per CT	25 PC per CT



## uvex super boss

- safety helmet with slots for uvex visors and earmuffs
- side Euroslot adapters (30 mm) for attaching earmuffs
- meets standard EN 397 and additional requirement for very low temperatures (-20 °C)
- conventional suspension harness for comfortable adjustable fit
- fitted with the 9790004 sweatband
- adjustable side ventilation slits
- six-point textile band attachment ensures optimal fit and comfort

uvex super boss with conventional suspension harness			
Art. no.	9750020	9750120	9750520
Colour	white	yellow	blue
Version	with long brim	with long brim	with long brim
Material	HDPE	HDPE	HDPE
Standard	EN 397, -20 °C	EN 397, -20 °C	EN 397, -20 °C
Sizes	52 to 61 cm	52 to 61 cm	52 to 61 cm
Order unit	PC	PC	PC
Outer packaging	25 PC per CT	25 PC per CT	25 PC per CT

# Safety Helmets

uvex airwing B-S · uvex airwing B-S-WR · uvex thermo boss



## uvex airwing B-S · uvex airwing B-S-WR

- safety helmet with slots for uvex visors and earmuffs
- side Euroslot adapters (30 mm) for attaching earmuffs
- meets standard EN 397 and additional requirement for very low temperatures (-30 °C)
- three variable air vents for maximum ventilation
- conventional suspension harness for comfortable adjustable fit (uvex airwing B-S)

- suspension harness with wheel ratchet for variable width adjustment (uvex airwing B-S-WR)
- fitted with the 9760005 sweatband
- shorter brim for a wider field of upward vision
- six-point textile band attachment ensures optimal fit and comfort

### uvex airwing B-S with conventional suspension harness

Art. no.	9762021	9762121	9762221	9762321	9762421	9762521
Colour	white	yellow	orange	red	green	blue
Version	with short brim	with short brim	with short brim	with short brim	with short brim	with short brim
Material	HDPE	HDPE	HDPE	HDPE	HDPE	HDPE
Standard	EN 397, -30 °C	EN 397, -30 °C	EN 397, -30 °C	EN 397, -30 °C	EN 397, -30 °C	EN 397, -30 °C
Sizes	51 to 61 cm	51 to 61 cm	51 to 61 cm	51 to 61 cm	51 to 61 cm	51 to 61 cm
Order unit	PC	PC	PC	PC	PC	PC
Outer packaging	25 PC per CT	25 PC per CT	25 PC per CT	25 PC per CT	25 PC per CT	25 PC per CT

### uvex airwing B-S-WR with wheel ratchet system

Art. no.	9762031	9762131	9762231	9762331	9762431	9762531
Colour	white	yellow	orange	red	green	blue
Version	with short brim	with short brim	with short brim	with short brim	with short brim	with short brim
Material	HDPE	HDPE	HDPE	HDPE	HDPE	HDPE
Standard	EN 397, -30 °C	EN 397, -30 °C	EN 397, -30 °C	EN 397, -30 °C	EN 397, -30 °C	EN 397, -30 °C
Sizes	52 to 61 cm	52 to 61 cm	52 to 61 cm	52 to 61 cm	52 to 61 cm	52 to 61 cm
Order unit	PC	PC	PC	PC	PC	PC
Outer packaging	25 PC per CT	25 PC per CT	25 PC per CT	25 PC per CT	25 PC per CT	25 PC per CT



## uvex thermo boss

- safety helmet with slots for uvex visors and earmuffs
- the helmet shell is made from heat-resistant polycarbonate and is suitable for use in high ambient temperatures.
- side Euroslot adapters (30 mm) for attaching earmuffs
- meets standard EN 397 and additional requirement (440 V AC) +150 °C
- conventional suspension harness for comfortable adjustable fit
- fitted with the 9790004 sweatband
- six-point textile band attachment ensures optimal fit and comfort

### uvex thermo boss

Art. no.	9754000	9754100	9754300
Colour	white	yellow	red
Version	with long brim	with long brim	with long brim
Material	PC reinforced with fibreglass		
Standard	EN 397 +150 °C, 440 V AC	EN 397 +150 °C, 440 V AC	EN 397 +150 °C, 440 V AC
Sizes	52 to 61 cm	52 to 61 cm	52 to 61 cm
Order unit	PC	PC	PC
Outer packaging	25 PC per CT	25 PC per CT	25 PC per CT

MADE IN GERMANY



# uvex pheos alpine

Head protection doesn't get much more versatile than this



The uvex pheos alpine combines the various requirements of the industrial sector (in accordance with EN 397) and mountain climbing or working at height (in accordance with EN 12492) in one helmet with an unparalleled fit.

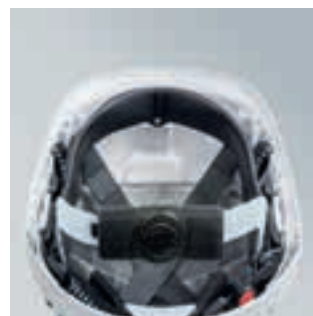

## Multifunctional

Thanks to the clip at the back of the helmet, the chin strap can be stored inside the helmet in line with EN 12492 and released as needed. Leather chin strap compatible with EN 397 also included.

## Excellent compatibility

The front and side slots make it easy to attach accessories.



## Additional comfort

Thanks to soft sweatband and wheel ratchet padding.

Clips for attaching goggles or LED head torches with headband.



# Safety Helmets

uvex pheos alpine



## uvex pheos alpine

- multifunctional helmet for working at heights and rescue operations
- combines the features of an industrial protection helmet (EN 397) with the requirements for a climbing helmet (EN 12492)
- light ABS helmet shell offers a high level of protection and durability
- shorter brim for a wider field of upward vision
- side Euroslot adapters (30 mm) for attaching earmuffs and visor
- options for attaching head torches and goggles
- permanently opened air vents
- meets standard EN 397 and additional requirements for very low temperatures (-30°C)
- riveted chin strap (art. no. 970005) for use in accordance with EN 397
- six-point textile band attachment ensures ideal fit and great comfort
- suspension harness with wheel ratchet system for variable width adjustment

- the helmet is delivered as standard with a black PU sweatband (art. no. 9760009); there is also an option of a light sweatband made of synthetic leather (art. no. 9760005)



product design award

2013

uvex pheos alpine with wheel ratchet system

Art. no.	9773050	9773150	9773250	9773350	9773450	9773550	9773950
Colour	white	yellow	orange	red	green	blue	black
Version	with short brim	with short brim	with short brim	with short brim	with short brim	with short brim	with short brim
Material	ABS	ABS	ABS	ABS	ABS	ABS	ABS
Standard	EN 397, -30 °C EN 12492	EN 397, -30 °C EN 12492	EN 397, -30 °C EN 12492	EN 397, -30 °C EN 12492	EN 397, -30 °C EN 12492	EN 397, -30 °C EN 12492	EN 397, -30 °C EN 12492
Sizes	52 to 61 cm	52 to 61 cm	52 to 61 cm	52 to 61 cm	52 to 61 cm	52 to 61 cm	52 to 61 cm
Order unit	PC,	PC,	PC,	PC,	PC,	PC,	PC,
Outer packaging	individually packed in CT 6 PC per CT	individually packed in CT 6 PC per CT	individually packed in CT 6 PC per CT	individually packed in CT 6 PC per CT	individually packed in CT 6 PC per CT	individually packed in CT 6 PC per CT	individually packed in CT 6 PC per CT

# Safety Helmets

uvex pheos E · uvex pheos E-WR · uvex pheos E-S-WR



## uvex pheos B · uvex pheos B-WR

- safety helmet with slots for uvex visors, earmuffs and lamps
- side Euroslot adapters (30 mm) for attaching earmuffs
- meets standard EN 397 and additional requirements for very low temperatures (-30 °C) and molten metal (MM) splash
- three variable air vents for maximum ventilation
- conventional suspension harness for comfortable adjustable fit (uvex pheos B)
- suspension harness with wheel ratchet for variable width adjustment (uvex pheos B-WR)
- fitted with the 9760005 sweatband
- six-point textile band attachment ensures optimal fit and comfort

uvex pheos B with conventional suspension harness						
Art. no.	9772020	9772120	9772220	9772320	9772520	9772920
Colour	white	yellow	orange	red	blue	black
Version	with long brim					
Material	HDPE	HDPE	HDPE	HDPE	HDPE	HDPE
Standard	EN 397	EN 397	EN 397	EN 397	EN 397	EN 397
	-30 °C, MM	-30 °C, MM	-30 °C, MM	-30 °C, MM	-30 °C, MM	-30 °C, MM
Sizes	51 to 61 cm	51 to 61 cm	51 to 61 cm	51 to 61 cm	51 to 61 cm	51 to 61 cm
Order unit	PC	PC	PC	PC	PC	PC
Outer packaging	25 PC per CT	25 PC per CT	25 PC per CT	25 PC per CT	25 PC per CT	25 PC per CT

uvex pheos B-WR with wheel ratchet system							
Art. no.	9772030	9772130	9772230	9772330	9772430	9772530	9772930
Colour	white	yellow	orange	red	green	blue	black
Version	with long brim	with long brim	with long brim	with long brim	with long brim	with long brim	with long brim
Material	HDPE	HDPE	HDPE	HDPE	HDPE	HDPE	HDPE
Standard	EN 397	EN 397	EN 397	EN 397	EN 397	EN 397	EN 397
	-30 °C, MM	-30 °C, MM	-30 °C, MM	-30 °C, MM	-30 °C, MM	-30 °C, MM	-30 °C, MM
Sizes	52 to 61 cm	52 to 61 cm	52 to 61 cm	52 to 61 cm	52 to 61 cm	52 to 61 cm	52 to 61 cm
Order unit	PC	PC	PC	PC	PC	PC	PC
Outer packaging	25 PC per CT	25 PC per CT	25 PC per CT	25 PC per CT	25 PC per CT	25 PC per CT	25 PC per CT



## uvex pheos B-S-WR

- safety helmet with slots for uvex visors, earmuffs and lamps
- side Euroslot adapters (30 mm) for attaching earmuffs
- meets standard EN 397 and additional requirements for very low temperatures (-30 °C) and molten metal (MM) splash
- three variable air vents for maximum ventilation
- suspension harness with wheel ratchet for variable width adjustment

- fitted with the 9760005 sweatband
- shorter brim for a wider field of upward vision
- six-point textile band attachment ensures optimal fit and comfort

uvex pheos B-S-WR with wheel ratchet system							
Art. no.	9772031	9772131	9772231	9772332	9772531	9772832	9772932
Colour	white	yellow	orange	red	blue	dark grey	black
Version	with short brim	with short brim	with short brim	with short brim	with short brim	with short brim	with short brim
Material	HDPE	HDPE	HDPE	HDPE	HDPE	HDPE	HDPE
Standard	EN 397	EN 397	EN 397	EN 397	EN 397	EN 397	EN 397
	-30 °C, MM	-30 °C, MM	-30 °C, MM	-30 °C, MM	-30 °C, MM	-30 °C, MM	-30 °C, MM
Sizes	52 to 61 cm	52 to 61 cm	52 to 61 cm	52 to 61 cm	52 to 61 cm	52 to 61 cm	52 to 61 cm
Order unit	PC	PC	PC	PC	PC	PC	PC
Outer packaging	25 PC per CT	25 PC per CT	25 PC per CT	25 PC per CT	25 PC per CT	25 PC per CT	25 PC per CT

# Safety Helmets

uvex pheos E · uvex pheos E-WR · uvex pheos E-S-WR



## uvex pheos E · uvex pheos E-WR

- safety helmet with slots for uvex visors, earmuffs and lamps
- side Euroslot adapters (30 mm) for attaching earmuffs
- suitable for use by electricians as helmet shell is fully enclosed
- meets standard EN 397 and additional requirements for very low temperatures (-30 °C) and molten metal (MM) splash and is approved in accordance with EN 50365 (1000 V AC)
- conventional suspension harness for comfortable adjustable fit (uvex pheos E)
- suspension harness with wheel ratchet for variable width adjustment (uvex pheos E-WR)
- fitted with the 9760005 (uvex pheos E) or 9760009 (uvex pheos E-WR) sweatband
- six-point textile band attachment ensures optimal fit and comfort

uvex pheos E with conventional suspension harness		
Art. no.	9770020	9770120
Colour	white	yellow
Version	with long brim	with long brim
Material	HDPE	HDPE
Standard	EN 397	EN 397
	-30 °C, MM	-30 °C, MM
	EN 50365, 1000 V AC	EN 50365, 1000 V AC
Sizes	51 to 61 cm	51 to 61 cm
Order unit	PC	PC
Outer packaging	25 PC per CT	25 PC per CT

uvex pheos E-WR with wheel ratchet system							
Art. no.	9770030	9770130	9770230	9770330	9770430	9770530	9770830
Colour	white	yellow	orange	red	green	blue	dark grey
Version	with long brim	with long brim	with long brim	with long brim	with long brim	with long brim	with long brim
Material	HDPE	HDPE	HDPE	HDPE	HDPE	HDPE	HDPE
Standard	EN 397	EN 397	EN 397	EN 397	EN 397	EN 397	EN 397
	-30 °C, MM	-30 °C, MM	-30 °C, MM	-30 °C, MM	-30 °C, MM	-30 °C, MM	-30 °C, MM
	EN 50365, 1000 V AC	EN 50365, 1000 V AC	EN 50365, 1000 V AC	EN 50365, 1000 V AC	EN 50365, 1000 V AC	EN 50365, 1000 V AC	EN 50365, 1000 V AC
Sizes	52 to 61 cm	52 to 61 cm	52 to 61 cm	52 to 61 cm	52 to 61 cm	52 to 61 cm	52 to 61 cm
Order unit	PC	PC	PC	PC	PC	PC	PC
Outer packaging	25 PC per CT	25 PC per CT	25 PC per CT	25 PC per CT	25 PC per CT	25 PC per CT	25 PC per CT



## uvex pheos E-S-WR

- safety helmet with slots for uvex visors, earmuffs and lamps
- side Euroslot adapters (30 mm) for attaching earmuffs
- suitable for use by electricians as helmet shell is fully enclosed
- meets standard EN 397 and additional requirements for very low temperatures (-30 °C) and molten metal (MM) splash and is approved in accordance with EN 50365 (1000 V AC)
- suspension harness with wheel ratchet for variable width adjustment
- fitted with the 9760009 sweatband
- shorter brim for a wider field of upward vision
- six-point textile band attachment ensures optimal fit and comfort

uvex pheos E-S-WR with wheel ratchet system								
Art. no.	9770031	9770131	9770231	9770331	9770431	9770531	9770832	9770931
Colour	white	yellow	orange	red	green	blue	dark grey	black
Version	with short brim	with short brim	with short brim	with short brim	with short brim	with short brim	with short brim	with short brim
Material	HDPE	HDPE	HDPE	HDPE	HDPE	HDPE	HDPE	HDPE
Standard	EN 397	EN 397	EN 397	EN 397	EN 397	EN 397	EN 397	EN 397
	-30 °C, MM	-30 °C, MM	-30 °C, MM	-30 °C, MM	-30 °C, MM	-30 °C, MM	-30 °C, MM	-30 °C, MM
	EN 50365	EN 50365	EN 50365	EN 50365	EN 50365	EN 50365	EN 50365	EN 50365
	1000 V AC	1000 V AC	1000 V AC	1000 V AC	1000 V AC	1000 V AC	1000 V AC	1000 V AC
Sizes	52 to 61 cm	52 to 61 cm	52 to 61 cm	52 to 61 cm	52 to 61 cm	52 to 61 cm	52 to 61 cm	52 to 61 cm
Order unit	PC	PC	PC	PC	PC	PC	PC	PC
Outer packaging	25 PC per CT	25 PC per CT	25 PC per CT	25 PC per CT	25 PC per CT	25 PC per CT	25 PC per CT	25 PC per CT



# Safety Helmets

uvex pheos IES · reflex set



### Integrated Eyewear System

The IES spectacle holder allows the uvex pheos/pheos s/i-works safety spectacles to be attached to a suspension harness using a spectacle clip. This allows for a defined resting position in the helmet and means that the spectacles can be used easily and quickly to prevent eyesight damage.



## uvex pheos IES

- safety helmet with slots for uvex visors, earmuffs, lamps and Integrated Eyewear System (IES)
- side Euroslot adapters (30 mm) for attaching earmuffs
- meets standard EN 397 and additional requirements for very low temperatures (-30 °C) and molten metal (MM) splash
- three variable air vents for maximum ventilation
- suspension harness with wheel ratchet for variable width adjustment – also has the option to mount uvex pheos, uvex pheos or uvex i-works safety spectacles
- fitted with the 9760007 sweatband
- six-point textile band attachment ensures optimal fit and comfort

uvex pheos IES with wheel ratchet system					
Art. no.	9772040	9772140	9772240	9772340	9772540
Colour	white	yellow	orange	red	blue
Version	with long brim				
Material	HDPE	HDPE	HDPE	HDPE	HDPE
Standard	EN 397	EN 397	EN 397	EN 397	EN 397
	-30 °C, MM	-30 °C, MM	-30 °C, MM	-30 °C, MM	-30 °C, MM
Sizes	55 to 61 cm	55 to 61 cm	55 to 61 cm	55 to 61 cm	55 to 61 cm
Order unit	PC	PC	PC	PC	PC
Outer packaging	25 PC per CT	25 PC per CT	25 PC per CT	25 PC per CT	25 PC per CT

**MADE IN GERMANY**

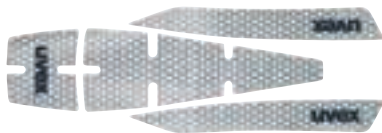

9790018



► Please contact our service hotline free of charge on **+49 911 9736-0**.



uvex pheos reflex set L (select preferred helmet colour)

## uvex pheos reflex set M

- highly reflective sticker set
- extremely high brightness with prism film
- easy to affix
- suitable for all uvex pheos and uvex pheos alpine safety helmets

uvex pheos reflex set M

Art. no. 9790018  
Order unit PC

## uvex pheos reflex set L

- safety helmet with highly reflective sticker set
- helmets are delivered with the stickers already applied
- customized helmets cannot be exchanged

uvex pheos reflex set L			uvex pheos reflex set L		
Art. no.	Colour	Version	Art. no.	Colour	Version
9772026	white	uvex pheos B with reflective sticker	9772038	white	uvex pheos B-S-WR with reflective sticker
9772126	yellow	uvex pheos B with reflective sticker	9772137	yellow	uvex pheos B-S-WR with reflective sticker
9772226	orange	uvex pheos B with reflective sticker	9772239	orange	uvex pheos B-S-WR with reflective sticker
9772326	red	uvex pheos B with reflective sticker	9772334	red	uvex pheos B-S-WR with reflective sticker
9772526	blue	uvex pheos B with reflective sticker	9772537	blue	uvex pheos B-S-WR with reflective sticker
9772926	black	uvex pheos B with reflective sticker	9770026	white	uvex pheos E with reflective sticker
9772035	white	uvex pheos B-WR with reflective sticker	9770126	yellow	uvex pheos E with reflective sticker
9772138	yellow	uvex pheos B-WR with reflective sticker	9770036	white	uvex pheos E-WR with reflective sticker
9772236	orange	uvex pheos B-WR with reflective sticker	9770136	yellow	uvex pheos E-WR with reflective sticker
9772437	green	uvex pheos B-WR with reflective sticker	9770536	blue	uvex pheos E-WR with reflective sticker
9772538	blue	uvex pheos B-WR with reflective sticker			
9772936	black	uvex pheos B-WR with reflective sticker			
Order quantity multiples/		25 PC			
Order unit					

# Safety Helmets Accessories



9790065  
with safety helmet  
(helmet not included)



9790075  
with safety helmet  
(helmet not included)



9790076  
with safety helmet  
(helmet not included)



9790068



9790066



9790086  
with safety helmet  
(helmet not included)



9790086

## uvex winter cap

- winter cap for use in all uvex helmets
- windproof and waterproof outer material
- all-around reflective strip
- side mesh to increase the wearer's attention to environmental influences (ear area)
- warming fleece lining

## uvex balaclava

- uvex balaclava is the ideal addition to the winter cap – with continuous size adjustment through hinged Velcro fastening

## uvex neck protection

- uvex neck protection for protection against rain, dust, splinters and solar radiation
- for use with all uvex helmets
- fitted with mount 9790022 to attach the neck protection in the uvex pheos helmet shell

## uvex cooling neck protection

- with unique cooling function – up to 8 hours cooling effect, protection from sunlight

	uvex winter cap	uvex balaclava	uvex neck protection	uvex cooling neck protection
Art. no.	9790065	9790068	9790066	9790076
Version	polyester/fleece	polyester/fleece	fleece	polyester
Colour	hi-viz yellow	hi-viz orange	black	yellow
Sizes	unisize	unisize	unisize	unisize
Order unit	PC	PC	PC	PC

9790006



9790010



9790015



9790016



9790012



## Paper caps · Winter caps

	Paper cap	Winter caps			
Art. no.	9790006	9790010	9790015	9790016	9790012
Version	gygienic visitor hoods	winter hat made of cotton and wool	winter hat made of polyester and wool	winter hat made of polyester and wool	winter hat made of cotton and wool
Colour	white	navy blue	black	black	navy blue
Sizes	unisize	unisize	S to M	L to XL	unisize
Order unit	100 PC	PC	PC	PC	PC

# Safety Helmets

## Accessories



9790000

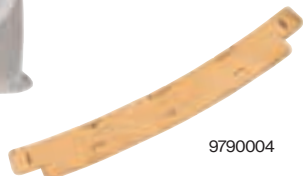

9790004



9772001



9760007



9760012



9760011



9760009



9760014



9760000



9760001



9760005

### Accessories for uvex super boss and uvex thermo boss

	Suspension harness for uvex super boss and uvex thermo boss	Sweatband for uvex super boss and uvex thermo boss
<b>Art. no.</b>	9790000	9790004
<b>Version</b>	Six-point textile attachment with sweatband	Artificial leather (leatherette)
<b>Order unit</b>	PC	PC

### Accessories for uvex pheos IES

	Suspension harness for IES For uvex pheos (Not pheos E and pheos alpine)	Sweatband for pheos IES
<b>Art. no.</b>	9772001	9760007
<b>Version</b>	Six-point textile suspension with textile sweatband with uvex pheos glasses clip	textile/foam material
<b>Order unit</b>	PC	PC

### Accessories for uvex pheos E-WR and uvex pheos alpine

	Suspension harness for uvex pheos E-WR	Suspension harness for uvex pheos alpine
<b>Art. no.</b>	9760012	9760011
<b>Version</b>	Six-point textile attachment with sweatband	Six-point textile attachment with sweatband
<b>Order unit</b>	PC	PC

	Sweatband for uvex pheos alpine and uvex pheos E-WR	Wheel ratchet padding
<b>Art. no.</b>	9760009	9760014
<b>Version</b>	PU, leather	polyester
<b>Order unit</b>	PC	PC

### Accessories for uvex pheos and uvex airwing

	Conventional suspension harness for uvex pheos and uvex airwing	Suspension harness for uvex pheos and uvex airwing (not for uvex pheos E) with wheel ratchet
<b>Art. no.</b>	9760000	9760001
<b>Version</b>	Six-point textile attachment with sweatband	Six-point textile attachment with sweatband
<b>Order unit</b>	PC	PC

	Sweatband for uvex pheos, uvex airwing and uvex pheos alpine
<b>Art. no.</b>	9760005
<b>Version</b>	Artificial leather (leatherette) with sweatband
<b>Order unit</b>	PC

# Safety Helmets

## Accessories

### Accessories for uvex pheos, uvex pheos alpine, uvex airwing, uvex super boss and uvex thermo boss



	Leather chin straps for uvex pheos (not for pheos IES and pheos E), uvex pheos alpine, uvex airwing, uvex superboss and uvex thermo boss	
<b>Art. no.</b>	9790005	
<b>Version</b>	Robust leather design with plastic eyelets with metal rivets, adjustable length	
<b>Order unit</b>	PC	

	Forked chin straps for uvex airwing and uvex pheos	Leather chin strap for uvex pheos IES
<b>Art. no.</b>	9790007	9790035
<b>Version</b>	textile band with push-button quick-action fastener plastic eyelets and chin pad, length can be adjusted	Robust leather design with plastic eyelets with metal rivets, length can be adjusted
<b>Order unit</b>	PC	PC

	Forked chin straps for uvex pheos (not for uvex pheos alpine) and uvex pheos E	
<b>Art. no.</b>	9790021	
<b>Version</b>	Textile strap with quick-release push-button fastening, plastic hooks and chin pad, adjustable length	
<b>Order unit</b>	PC	

	IES mount with sliding element for uvex pheos IES System	Penholder for uvex pheos and uvex pheos E
<b>Art. no.</b>	9772002	9790023
<b>Version</b>	plastic	plastic
<b>Order unit</b>	PC	PC

	Goggles clip for uvex pheos/ chin strap clip for uvex pheos alpine	
<b>Art. no.</b>	9790022	
<b>Version</b>	Textile strap with quick-release push-button fastening, plastic hooks and chin pad, adjustable length	
<b>Order unit</b>	PC	

	uvex spiderneck neck support	
<b>Art. no.</b>	9790149	
<b>Version</b>	suitable for the uvex pheos and uvex airwing with wheel ratchet helmets suspension harness, wheel ratchet padding can be removed for use with the uvex pheos alpine increases neck support, improves comfort, improved weight distribution across the helmet easy installation: is threaded over the wheel ratchet	
<b>Order unit</b>	PC	

	Business card holder	
<b>Art. no.</b>	9790166	
<b>Content</b>	10 holders + 20 PVC cards	
<b>Order quantity multiples</b>	10 PC	

	uvex helmet bag for storing and transporting the uvex safety helmet	Helmet slot sealing plug set
<b>Art. no.</b>	9790071	9790077
<b>Version</b>	polyester	plastic
<b>Order unit</b>	PC	PC



# Safety Helmets

## Accessories: Head torchs

► All uvex LED head torches fit into the front slot of the uvex pheos, uvex pheos alpine.

9790062  
9790063



9790029



9790064



9790069

### uvex head torch pheos Lights · pheos Lights EX

- LED helmet torch with two separate reflectors for distance and area lighting
- four different operating modes
- compact design, very low weight (80 g), extremely robust
- power source: 1.7 Ah-Li-Ion battery
- luminous flux: up to max. 115 lumen
- illuminance: max. 6500 lux
- light duration: 11 hours
- operating temperature: -20 °C to +60 °C
- charge adapter and micro-USB charger included
- protection class IP 67 (dust-tight and waterproof)
- 9790063: ATEX certification II 2G Ex ib IIC T4

Press switch	Modes	Lumen	Range	Light duration
Area light	low	55	5 m	11 h
	high	115	10 m	5.5 h
Distance light	low	55	50 m	11 h
	high	115	100 m	5.5 h

### KS-6002-DUO

- LED helmet torch with two separate precision lenses for distance and area lighting
- 4 different operating modes
- compact design
- Beam can be infinitely adjusted to suit the area to be lit
- power source: lithium-Ion battery, 3.7 V, 1.7 Ah
- luminous flux: up to max. 200 lumen
- illuminance: max. 8500 lux
- light duration: up to 11 hours
- operating temperature: -20°C to +60°C
- protection class: IP 67 (dust-tight and waterproof)
- charger included
- charging time: approx. 5 hours

Press switch	Modes	Lumen	Range	Light duration
Area light	normal	80	5 m	11 h
	strong	200	10 m	4 h
Distance light	normal	80	80 m	11 h
	strong	160	180 m	5.5 h

### LED head torch u-cap sport · uvex pheos helmet adapter

- LED head torch with two separate reflectors for distance and area lighting
- two different operating modes
- sturdy design, with very low weight (55 g without batteries)
- power source: 3 x AAA batteries (not included)
- luminous flux: up to max. 190 lumen
- illuminance: approx. 4000 lux
- light duration: up to max. 150 hrs
- operating temperature: -20 °C to +45 °C
- protection class IP 66 (complete protection against dust and powerful water jets)
- Adapter for the LED head torch u-cap sport for combining with the uvex pheos and uvex pheos alpine helmets

Press switch for 1 s	Modes	Lumen	Range	Light duration
Area light	high	30	7 m	80 h
	low	10	3 m	150 h
	medium	40	80 m	70 h
Distance light	high	100	110 m	30 h
	low	5	10 m	150 h

	LED head torch pheos Lights	LED head torch pheos Lights EX	LED head torch KS-6002-DUO	LED head torch uvex u-cap sport	uvex pheos helmet adapter
<b>Art. no.</b>	9790062	9790063	9790029	9790064	9790069
<b>Version</b>	for uvex pheos helmets	for uvex pheos helmets – ATEX	for uvex pheos helmets	for uvex u-cap sport	for LED head torch uvex u-cap sport for combining with the uvex pheos and uvex pheos alpine helmets
<b>Order unit</b>	PC	PC	PC	PC	PC

9790213



### Suprabeam V3air rechargeable

- LED head torch with sliding focus for distance and area lighting
- can be dimmed between 180 and 8 lumens
- two different operating modes
- robust design with low weight (148 g); weight balanced by battery at the rear
- power source: 1.4-Ah LiPo battery
- luminous flux: up to max. 320 lumen
- light duration: max. 100 hours
- operating temperature: -30°C to +60°C
- IPX4 protection (protection against splashing water from all directions)
- highly adjustable angle: illuminates an area in the distance or directly in front of the wearer
- range up to 210 metres

Suprabeam V3air rechargeable	
<b>Art. no.</b>	9790213
<b>Version</b>	with headband; suitable for all uvex helmets with article 9790214
<b>Order unit</b>	PC



9790214

### Universal silicone strap for Suprabeam V3air rechargeable

- for attachment to all uvex protective helmets
- prevents lamp from slipping off helmet

Universal silicone strap	
<b>Art. no.</b>	9790214
<b>Version</b>	for V3air rechargeable
<b>Order unit</b>	PC





uvex

# Visors and face protection

# Visor lenses, certification and norms

Specially developed to meet the needs of forestry workers



## Polycarbonate lenses with uvex supravision excellence coating

Polycarbonate has a high mechanical impact strength. Coated lenses are anti-fog on the inside, and scratch- and chemical-resistant on the outside. The anti-fogging properties are permanent even after repeated cleaning. The lenses are especially easy to clean and less susceptible to dirt due to the non-stick nanotechnology.

## Cellulose acetate lenses

Face protection visors made of cellulose acetate are ideally suited for protection against chemicals.

## Nylon mesh

is light in weight and non-conductive. It is very flexible and durable, and therefore frequently used in agriculture and forestry.

## Stainless steel mesh

is robust and has excellent stability and long life. Stainless steel mesh visors offer a higher light transmission than nylon mesh visors and are used for more rugged work in agriculture and forestry.

## Standards at a glance

### EN 166 – Personal eye protection

The European standard EN166 applies to all types of eye protection. EN 166 visors are made of frames and lenses.

### Certification according to DIN EN 166

Marking on frame

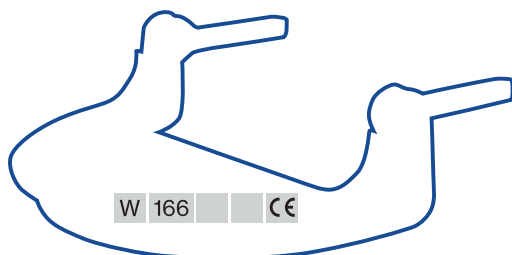

Marking on lenses

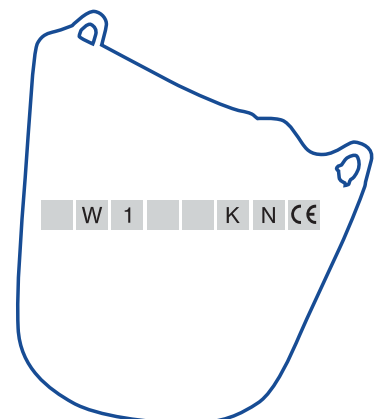

A detailed description of frame and lens markings can be found on page 15

# Labelling and norms

## EN 170 – Ultraviolet protection filters

In the standards for special product requirements, the standard EN 170 sets out levels of protection and transmission requirements for ultraviolet protection filters. Excessive exposure to ultraviolet light can cause the lens of the eye to lose its transparency, which may cause

visual impairment or loss of vision. Visor lenses in accordance with EN 170 therefore meet performance requirements to protect the eye from ultraviolet radiation during hazardous work.

## EN 1731 – Textile face protection

The European standard EN 1731 describes all requirements for personal eye and face protection made of textile. EN 1731 visors consist of frames and lenses.

Technical information on the frame and the lens are specified according to EN 1731 in the following order:

- Identification of the manufacturer
- Number of European standard
- Symbol for mechanical strength

Mechanical strength	
none	without mechanical strength (filters only)
S	increased strength (filters only)
F	low energy impact (45m/s)
B	medium energy impact (120m/s)
A	high energy impact (190 m/s)
T	tested at extreme temperatures (-5°C and +55°C)



## GS-ET 29

When working on energised electrical systems and equipment, the risk of a short circuit electric arc must be assessed. Short circuit electric arcs are usually caused by a short circuit between the electrical lines. The GS-ET 29 test principle is an additional requirement for the testing and certification of electrician face protection. These visors are a category 3 product, which means there is a risk of physical injury and

death. With regards to different intensities of short circuit electric arcs, the certified products must be assessed for their suitability for the respective application. Here, there are distinctions between two classes, Class 1 – up to 4 kA – and Class 2, up to 7 kA.

## Certification according to GS-ET 29

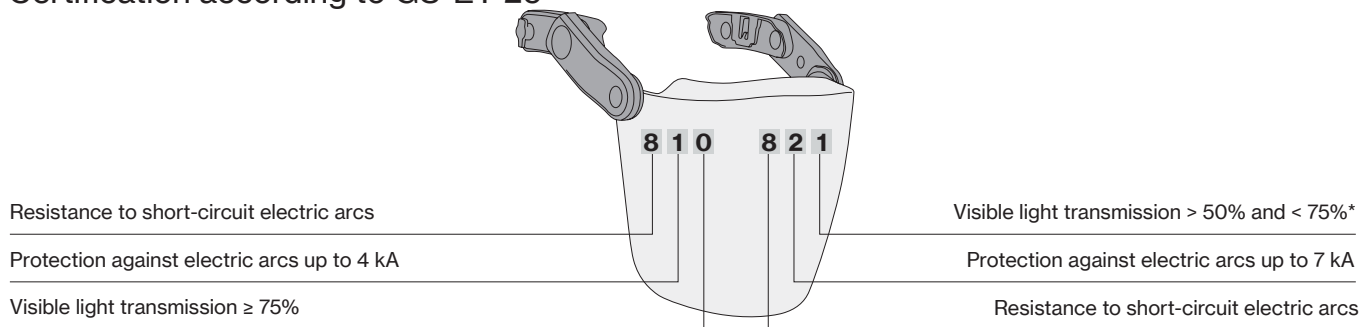

Previously



According to 7 kA short circuit electric arc

uvex

## uvex i-gonomics

### Face protection with measurably greater relief

uvex i-gonomics redefines wearer comfort: The innovative product system boasts an ergonomic fit, lightweight design and ideal climate characteristics. This makes our face protection more comfortable to wear and gives it optimal flexibility – so maximum performance can be achieved at all times, even under extreme conditions.



## uvex pheos faceguard

### Innovative and systematic face protection.

The uvex pheos faceguard has been ergonomically designed. It evenly distributes the weight across the body's centre of gravity, helping the wearer to adopt a natural posture. The slim design ensures optimal freedom of movement and the robust polycarbonate visor provides a clear view.

Thanks to uvex coating technology, the guard is anti-fog on the inside and extremely scratch- and chemical-resistant on the outside. uvex UV400 offers the maximum possible protection against UV rays. With its wide range of accessories, the multi-system is suitable for numerous applications and can be adapted to suit each and every one of them.



Scan for more information about the uvex i-gonomics product system.

## force 4.0

**Test method:**  
Torque measurement in the neck area\*

**Test result:**  
Torque = 0.4 Nm (IV 4.0)

**Relief for the head and neck, reduced fatigue**

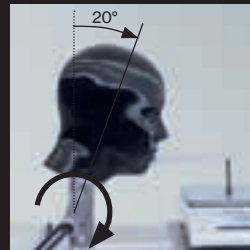

## weight 3.9

**Test method:**  
Weighing the face protection without hearing protection

**Test result:**  
Product weight = 391 g (IW 3.9)

**Comfortable fit, better performance**



**Relief index calculation:**

The relief index is calculated from the average of the three index values (IV) – force, weight and climate – and ranges from 0 (= poor) to 5 (= optimum).

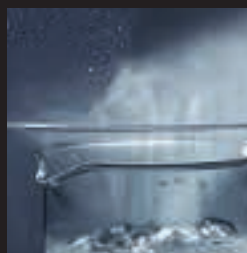

## clima 4.8

**Test method:**  
uvex benchmark "anti-fog" test

**Test result:**  
Anti-fog performance = 29 points (IV 4.8)

**Fog-free view, even in extreme climates**



# Visors and face protection

## uvex pheos visor system

### Perfect 'resting position' for the visor and hearing protection

The visor can be locked above the helmet shell when not required and the hearing protection can be folded back. Everything fits closely to the helmet and is perfectly balanced over the body's centre of gravity. This means the neck muscles are not placed under strain by any unnecessary weight, ensuring excellent wearer comfort and maximum freedom of movement.

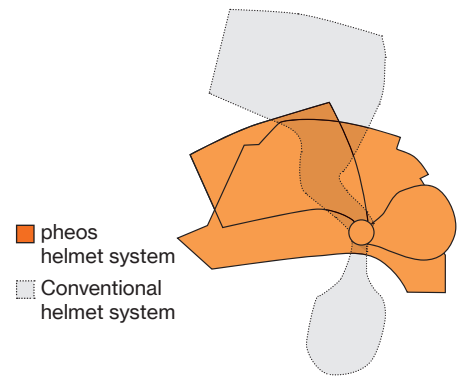

### Reliable face protection

The anti-fog and scratch-resistant visor is made of high-quality polycarbonate that meet the highest optical quality class. The visor fits the helmet seamlessly, leaving no gaps. The injection-moulded transparent peak provides protection against any particles penetrating the inside of the visor.



<b>Art. no.</b>	uvex pheos 9906002	uvex pheos SLB 1 9906005	uvex pheos SLB 2 9906007
<b>Version</b>	uvex supravision excellence with mechanical levers and bayonet connection for hearing protection	uvex supravision excellence certified as Class 1 visor for protection from electrical arcs, with mechanical levers and bayonet connection for hearing protection	uvex supravision excellence certified as Class 2 visor for protection from electrical arcs with mechanical levers and chin protection and bayonet connection for hearing protection
<b>Standard</b>	EN 166, EN 170	EN 166, EN 170	EN 166, EN 170
<b>Frame</b>	black W 166 3 8-2 9 B CE 0196	black W 166 3 8-2 9 B CE 0196	black W 166 3 8-2 9 B CE 0196
<b>Lens</b>	PC clear UV 400 2C-1.2 W 1 B 9 KN CE 0196	PC clear UV 400 2C-1.2 W 1 B 8-1-0 9 KN CE 0196	PC blue UV 400 2C-1.2 W 1 B 8-2-0 9 KN CE 0196
<b>Order unit</b>	PC, individually packed in polythene bags	PC, individually packed in polythene bags	PC, individually packed in polythene bags
<b>Outer packaging</b>	24 PC per CT	24 PC per CT	24 PC per CT
<b>Replacement lens</b>	9906013, individually packed in polythene bags	9906012, individually packed in polythene bags	9906017, individually packed in polythene bags
<b>Art. no.</b>	uvex pheos magnetic 9906003	uvex pheos SLB 1 magnetic 9906006	uvex pheos SLB 2 magnetic 9906008
<b>Version</b>	uvex supravision excellence with magnetic levers	uvex supravision excellence certified as Class 1 visor for protection from electrical arcs, with magnetic levers	uvex supravision excellence certified as Class 2 visor for protection from electrical arcs with magnetic levers and chin protection
<b>Standard</b>	EN 166, EN 170	EN 166, EN 170	EN 166, EN 170
<b>Frame</b>	black W 166 3 8-2 9 B CE 0196	black W 166 3 8-2 9 B CE 0196	black W 166 3 8-2 9 B CE 0196
<b>Lens</b>	PC clear UV 400 2C-1.2 W 1 B 9 KN CE 0196	PC clear UV 400 2C-1.2 W 1 B 8-1-0 9 KN CE 0196	PC blue UV 400 2C-1.2 W 1 B 8-2-0 9 KN CE 0196
<b>Order unit</b>	PC, individually packed in polythene bags	PC, individually packed in polythene bags	PC, individually packed in polythene bags
<b>Outer packaging</b>	24 PC per CT	24 PC per CT	24 PC per CT
<b>Replacement lens</b>	9906013, individually packed in polythene bags	9906012, individually packed in polythene bags	9906017, individually packed in polythene bags

# Visors and face protection

## uvex pheos visor system

### uvex pheos visor

- polycarbonate visors with uvex supravision excellence coating technology
- visor is anti-fog on the inside and exceptionally scratch- and chemical-resistant on the outside. The anti-fogging properties are permanent, even after repeated cleaning
- easy to clean thanks to non-stick nanotechnology
- available with two mounting options: mechanical levers or automatic magnetic locks
- visors 9906002 and 9906003 can be combined with the industrial protection helmets:
  - uvex pheos B-S-WR
  - uvex pheos E-S-WR
  - Helmet for working at height uvex pheos alpine (visor adapter art. no. 9790067 required)
- visors uvex pheos SLB 1 (9906005 and 9906006) and uvex pheos SLB 2 (9906007 and 9906008) can be combined with the uvex pheos E-S-WR industrial safety helmet
- lenses can be changed
- fulfils standards EN 166 and EN 170
- certified for areas of application 3 (liquids) and 9 (molten metal and hot solids)
- uvex pheos SLB 1 visors are certified in accordance with GS-ET 29 as Class 1 visors for protection from electrical arcs (4kA)
- uvex pheos SLB 2 visors are certified in accordance with GS-ET 29 as Class 2 visors for protection from electrical arcs (7kA)
- you can find the combination options on the next page (page 126)



### Magnetic and mechanical locking system

All visors are pre-assembled with a helmet adapter. This is clicked into the side helmet slot and remains permanently attached there.

With the magnetic locking system, the attachment parts, visor and earmuffs can be removed easily at any time without having to remove the helmet. The visor is released with a click of the lateral locking system. When reassembled, the parts automatically snap back into place. This allows the helmet to remain comfortably on your head.

If the product is equipped with a mechanical locking system, the earmuffs can be removed at any time via a bayonet connection. The mechanical visor remains permanently attached to the helmet.

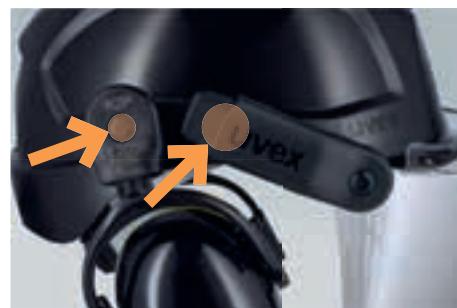

**Magnetic**  
locking system for visors and earmuffs with a magnetic connection











**Mechanical**  
locking system for visors and earmuffs with a bayonet connection

## Visors and face protection

Combination options and accessories

### Combination options uvex pheos visors

	Art. no.	Visor frame	Visor	Protection	Suitable helmets	Earmuffs
	9906002	mechanical	polycarbonate, clear	against mechanical influences (e.g. sparks, splinters)	all uvex pheos helmets with short brim	2600214 
	9906003	magnetic	polycarbonate, clear	against mechanical influences (e.g. sparks, splinters)	uvex pheos alpine (with visor adapter 9790067)	2600215 
	9906005	mechanical	polycarbonate, clear with UV absorber	against electrical arcs up to 4 kA (kiloamperes)	uvex pheos E-S-WR	2600214
	9906006	magnetic	polycarbonate, clear with UV absorber	against electrical arcs up to 4 kA (kiloamperes)		2600215
	9906007	mechanical	polycarbonate, blue with UV absorber and chin section	against electrical arcs up to 7 kA (kiloamperes)		2600214
	9906008	magnetic	polycarbonate, blue with UV absorber and chin section	against electrical arcs up to 7 kA (kiloamperes)		2600215



### uvex pheos visor system accessories

Visor adapter	
<b>Art. no.</b>	9790067
<b>Version</b>	for combining with the helmet for working at height uvex pheos alpine for inserting on the inside of the visor's face cover (visor not included)
<b>Order unit</b>	PC, individually packed in polythene bags

Helmet adapter	
<b>Art. no.</b>	9790078
<b>Version</b>	helmet adapter for use with uvex pheos K2P magnet earmuffs (2600215) without visor, is only required if no visor is used
<b>Order unit</b>	PR, individually packed in polythene bags

Sunglare filter/rain cover	
<b>Art. no.</b>	9790074
<b>Version</b>	to protect against sun and rain, for insertion on the inside of the face cover of the visor, cannot be combined with the visors uvex pheos SLB 1 and uvex pheos SLB 2
<b>Order unit</b>	PC, individually packed in polythene bags

Microfibre case	
<b>Art. no.</b>	9954362
<b>Version</b>	cloth bag to store and transport uvex visors and uvex helmets, black
<b>Order unit</b>	PC, loose



# Visors and face protection

9790 · 9725 · 9726 · Forestry worker visor



9790048



9790047



9924010

## uvex 9790

- robust polycarbonate visor for uvex industrial safety helmets and uvex helmet earmuffs 3200H, K1H and K2H
- for use during electrical work, a suitable electrician's helmet and dielectric helmet earmuffs must be used
- visor lens, helmet bracket and adapter must be ordered as individual parts
- additional adapters (art. no. 9924010) are required for the helmet and visor combination (without helmet earmuffs)



► helmet, helmet bracket and earmuffs are not included.

Lens	
Art. no.	9790048
Version	uncoated
	Short circuit electric arc classification Class 1
	Fixed on helmet bracket 9790047
Standard	EN 166, EN 170, GS-ET 29
Lens	PC clear, UV 400
	2C-1,2 W 1 B 8-1-0 9 CE 0196
Order unit	PC, individually packed in polythene bags
Outer packaging	100 PC per CT

	Helmet bracket	Adapter
Art. no.	9790047	9924010
Version	Helmet bracket for visor 9790 (9790048)	Adapter for attaching without earmuffs
Frame	black	
	W 166 3 8-1 9 B CE 0196	
Order unit	PC, individually packed in polythene bags	
Outer packaging	90 PC per CT	500 PC per CT



9725514  
9726014

## uvex 9725 · uvex 9726

- polycarbonate and cellulose acetate visors with adapters for attaching on the side helmet slots
- easy to change lenses
- not combinable with earmuffs
- suitable for helmets uvex airwing and uvex superboss

► Helmet not included!

	9725	9726
Art. no.	9725514	9726014
Replacement lens	9050517	9723017
Version	anti-fog on the inside	uncoated
	Material thickness: 1 mm	Material thickness: 1 mm
Standard	EN 166, EN 170	EN 166, EN 170
Frame	black	black
	W 166 3-F CE	W 166 3-B CE
Lens	CA clear, UV 380	PC clear, UV 400
	2C-1,2 W 1 FN CE	2C-1,2 W 1 B CE
Order unit	PC, individually packed in polythene bags	
Outer packaging	20 PC per CT	20 PC per CT



## uvex pheos forestry worker visor

- metal mesh visor for forestry work
- suitable for helmet uvex pheos ABS
- lens certification: W EN 1731:2006-F

Further information can be found on page 106/107.

## uvex pheos faceguard

Face protection system

Innovative face protection without helmet. The system consists of a height- and width-adjustable head mount and a high-quality polycarbonate visor. The visor can be locked in any position and features uvex coating technology for a long field of vision and fog-free view. The earmuffs can be attached and removed quickly using a rotating mechanism. This allows you to customise the multi-system to suit your needs.



### The uvex multi-system in detail



**Centre of gravity over the middle of the head**  
Relieves the neck muscles and spine

Individual height adjustment of system for a custom fit

**Highly adjustable wheel ratchet system with wide neck piece**  
infinitely variable single-handed width adjustment with wheel ratchet system for a customised, comfortable fit.  
Suitable for head sizes 52–64



**Suspension harness and sweatband**  
Adapts comfortably to the head shape

**Multiposition lockable visor**  
Lenses can be changed

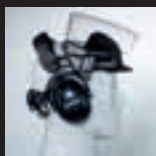

**Removable earmuffs**  
For additional protection

**Visor made from robust polycarbonate**  
Scratch-resistant on the outside Anti-fog on the inside UV 400 protection

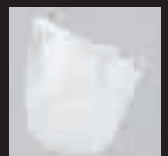

### The benefits of the uvex pheos faceguard at a glance:

- fully pre-assembled face protection system — ready to use at any time
- wide field of vision with the highest optical quality
- sturdy polycarbonate visor with anti-fog and scratch-resistant uvex supravision excellence coating
- low weight and balanced centre of gravity to relieve the spine
- expandable system with high modularity
- replaceable individual parts
- comfortable fit even with glasses and respirators



Further information can be found at [uvex-safety.com/en/pheosfaceguard](https://uvex-safety.com/en/pheosfaceguard) (or scan the QR code).

# uvex pheos faceguard

Face protection system

## Designed to protect the face and neck

The uvex pheos faceguard has been ergonomically designed. The face protection system has been designed to evenly distribute the weight across the body's centre of gravity. The low weight and ergonomic centre of gravity supports a natural head posture, minimising strain on the neck and back. The narrow design and wide field of vision help to support the natural posture of the head and neck.



Did you know that our neck is already exposed to four to five kilograms at a zero degree angle of inclination? The further the incline, which is often the case in industries such as construction, the greater the strain.

Learn more in our uvex experts blog at [uvex.safety.com/blog](http://uvex.safety.com/blog)



9790211



9790212

<b>Art. no.</b>	uvex pheos faceguard 9790211	uvex pheos faceguard with hearing protection 9790212
<b>Version</b>	Pre-assembled system for head sizes 52-64 cm, Polycarbonate lens, uvex supravision excellence coating, Without hearing protection	Pre-assembled system for head sizes 52-64 cm, Polycarbonate lens, uvex supravision excellence coating, With earmuffs K1P (SNR: 28 dB), further information can be found on page 99
<b>Standard</b>	EN 166, EN 170	EN 166, EN 170, EN 352
<b>Frame</b>	W 166 39B CE	W 166 39B CE
<b>Lens</b>	PC, clear, UV 400 2C-1.2 W 1 B 9 KN CE 0196	PC, clear, UV 400 2C-1.2 W 1 B 9 KN CE 0196
<b>Order unit</b>	PC, individually packed in CT	PC, individually packed in CT

## Accessories



9760107



9760108



9906013



9790074



2600216

<b>Art. no.</b>	replacement suspension harness 9760107	replacement sweatband 9760108	replacement lens visor 9906013	sun protection 9790074	hearing protection earplugs K1P 2600216
<b>Version</b>	Plastic suspension harness for head sizes 52-64 cm	Textile	Polycarbonate lens uvex supravision excellence coating	Protects against sun and rain is inserted on the visor	Earmuffs for uvex pheos faceguard SNR 28 dB
<b>Order unit</b>	PC, individually packed in polythene bags	PC, individually packed in polythene bags	PC, individually packed in polythene bags	PC, individually packed in polythene bags	PR, in pairs in CT

## Safety Helmets

uvex Visors · safety Goggles



9705014



9707014



9302510



9706514



9708514



9301544

### uvex 9705 · uvex 9706

- cellulose acetate visor with integrated forehead cover
- easy to change lenses
- cannot be combined with safety helmets
- flip-up mechanism with continuous adjustment
- head size can be easily adjusted using a twist lock

### uvex 9707 · uvex 9708

- cellulose acetate visor with integrated forehead cover and additional protective cap made from impact-resistant polystyrene
- easy to change lenses
- flip-up mechanism with continuous adjustment
- head size can be easily adjusted using a twist lock

### uvex goggles with helmet bracket

- ▶ Helmet and earmuffs not included!
- ▶ Additional adapters are required for attaching the goggles without earmuffs:  
**Art. no. 9924010**

	visor 9705	visor 9706	visor 9707	visor 9708
<b>Art. no.</b>	9705014	9706514	9707014	9708514
<b>Version</b>	uncoated	anti-fog on the inside	uncoated	anti-fog on the inside
<b>Standard</b>	EN 166, EN 170	EN 166, EN 170	EN 166, EN 170	EN 166, EN 170
<b>Frame</b>	black	black	black	black
	W 166 3-F DIN CE 0196	W 166 3-F DIN CE 0196	W 166 3 F DIN CE 0196	W 166 3 F DIN CE 0196
<b>Lens</b>	CA clear, UV 380 W 1 F DIN CE	CA clear, UV 380 W 1 FN DIN CE	CA clear, UV 380 W 1 F DIN CE	CA clear, UV 380 W 1 F DIN CE
<b>Order unit</b>	PC, individually packed in polythene bags			
<b>Outer packaging</b>	15 PC per CT		10 PC per CT	10 PC per CT
<b>Replacement lens</b>	9060017	9050517	9060017	9050517

uvex ultrasonic	
<b>Art. no.</b>	9302510
<b>Version</b>	uvex supravision extreme reduced ventilation
<b>Standard</b>	EN 166, EN 170
<b>Frame</b>	blue, grey W 166 34 B CE
<b>Lens</b>	PC clear, UV 400 2C-12 W 1 B KN DIN CE
<b>Order quantity multiples</b>	4 PC

uvex ultravision	
<b>Art. no.</b>	9301544
<b>Version</b>	anti-fog
<b>Standard</b>	EN 166, EN 170
<b>Frame</b>	transparent grey W 166 34 F CE
<b>Lens</b>	CA clear, UV 380 2-1.2 W 1 FN DIN CE
<b>Order quantity multiples</b>	4 PC

# Accessories

uvex pheos



	uvex pheos B	uvex pheos B-WR	uvex pheos B-S-WR	uvex pheos E	uvex pheos E-WR	uvex pheos E-S-WR	uvex pheos IES	uvex pheos alpine
9760000 Conventional suspension harness	■	■	■	■	■	■	■	-
9760001 Suspension harness with rotating size adjusters	■	■	■	-	-	-	■	-
9760011 Suspension harness for pheos alpine	-	-	-	-	-	-	-	■
9760012 Suspension harness for uvex pheos E-WR	■	■	■	■	■	■	■	-
9772001 Suspension harness IES	■	■	■	-	-	-	■	-
9760009 Sweatband uvex pheos alpine and uvex pheos E-WR	■	■	■	■	■	■	■	■
9760007 Sweatband IES	-	-	-	-	-	-	■	-
9760005 Sweatband, synthetic leather	■	■	■	■	■	■	-	-
9790035 Leather chin straps IES	■	■	■	-	-	-	■	-
9790005 Leather chin straps	■	■	■	-	-	-	-	■
9790021 Forked chin straps	■	■	■	■	■	■	■	-
9790023 Pen holder	■	■	■	■	■	■	■	-
9772002 Mount	-	-	-	-	-	-	■	-
9790022 Goggles clip, chin strap clip	■	■	■	■	■	■	■	■
9790065 Winter cap, hi-viz yellow	■	■	■	■	■	■	■	■
9790066 Balaclava	■	■	■	■	■	■	■	■
9790068 Winter cap, hi-viz orange	■	■	■	■	■	■	■	■
9790075 Neck protection, orange	■	■	■	■	■	■	■	■
9790076 Neck protection, yellow	■	■	■	■	■	■	■	■
9790086 uvex cooling neck protection	■	■	■	■	■	■	■	■
9790149 spiderneck neck support	-	■	■	-	■	■	■	■
9790166 Business card holder	■	■	■	■	■	■	■	■
9906002 uvex pheos visor	-	-	■	-	-	■	-	■
9906003 uvex pheos visor SLB1	-	-	-	-	-	■	-	-
9906005 uvex pheos visor SLB1	-	-	-	-	-	■	-	-
9906006 uvex pheos visor SLB2	-	-	-	-	-	■	-	-
9906007 uvex pheos visor SLB2	-	-	-	-	-	■	-	-
2600201 uvex K1H	■	■	■	-	-	-	■	■
2600202 uvex K2H	■	■	■	-	-	-	■	■
9790062 LED head torch pheos Lights	■	■	■	-	-	-	■	■
9790063 LED head torch pheos Lights EX	■	■	■	-	-	-	■	■
9790029 LED head torch KS-6001 DUO	■	■	■	-	-	-	■	■
9790064 LED head torch u-cap sport	■	■	■	■	■	■	■	■
9790069 uvex pheos helmet adapter	■	■	■	■	■	■	■	■

■ supplied as standard

■ compatible

- not compatible

# Accessories

uvex airwing · uvex super boss · uvex thermo boss



	uvex airwing B	uvex airwing B-W/R	uvex airwing B-S	uvex airwing B-S-W/R	uvex super boss	uvex thermo boss
9760000	Conventional suspension harness	■	■	■	-	-
9760001	Suspension harness with rotating size adjusters	■	■	■	-	-
9790000	Suspension harness for uvex super boss / uvex thermo boss	-	-	-	■	■
9760005	Sweatband	■	■	■	-	-
9790004	Sweatband for uvex super boss / uvex thermo boss	-	-	-	■	■
9790005	Leather chin straps	■	■	■	■	■
9790007	Forked chin straps	■	■	■	■	■
9790065	Winter cap, yellow	■	■	■	■	■
9790066	Balaclava	■	■	■	■	■
9790068	Winter cap, orange	■	■	■	■	■
9790075	Neck protection, orange	■	■	■	■	■
9790076	Neck protection, yellow	■	■	■	■	■
9790086	uvex cooling neck protection	■	■	■	■	■
9790047	Helmet bracket uvex 9790	■	■	■	-	-
9790048	Visor lens, PC	■	■	■	-	-
2600201	uvex K1H	■	■	■	■	■
2600202	uvex K2H	■	■	■	■	■

■ supplied as standard

■ compatible

- not compatible



# Safety helmets to match your corporate identity

## Individual safety helmets

uvex gives you the option to customise all uvex helmets and bump caps so that your employees' equipment matches your corporate identity specifications.

Please contact the uvex service centre with your requests at any time.

**Tel. +49 911 9736-0 · Email: Individualisierung@uvex.de**

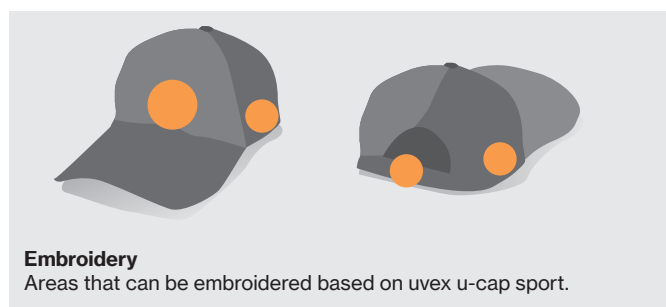
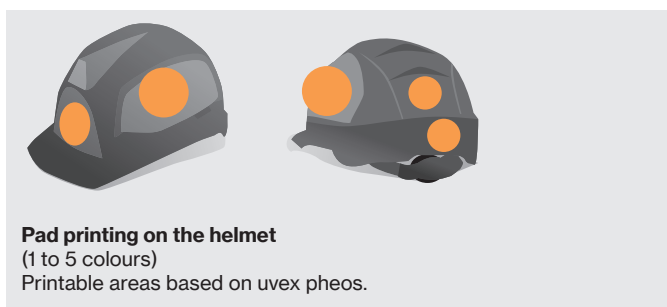

Customisation on the helmet	uvex pheos, uvex airwing, uvex superboss, uvex thermoboss	uvex pheos alpine
Special colour	from 300 units with supplemental charge from 600 units no additional cost	from 600 units no additional cost
new variant:		
– existing colour as a variant, electrician or chemist	from 300 units	
– existing colour with shortened brim	from 100 units	
– existing helmet, other interior, with chin strap	from 25 units	
Finish: Printed, sticker, reflex set	from 25 units reorder quantity: 25 units	

Customisation of bump caps	
Special colour	from 1,000 units
new variant:	
– with existing colour	from 600 units
Finish: Embroidered, printed	from 25 units

- Please note the following conditions:
- minimum order value 25 caps
- reorder quantity: 25 units
- number of colours to be embroidered: up to 14
- textile cap in special colour: from 1000 units
- vector file (.eps, .ai) and image file (.jpg, .pdf) required as template

## How individual can you be?

We will be happy to advise you on the technical options for customising our safety helmets.

# uvex u-cap sport

Guaranteed head protection with a sporty design

Reliable protection that looks good: uvex u-cap sport is an innovative baseball bump cap in accordance with Norm EN 812. The ergonomically shaped shell with integrated shock-absorbing elements ensures safety and optimal comfort. To give your team a uniform appearance, this model is also available as a standard baseball cap for employees working in environments where head protection is not compulsory.

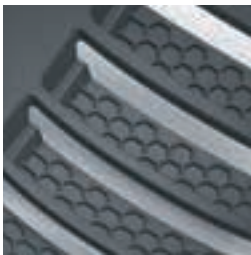

**Integrated shock-absorbing elements with honeycomb structure**

The specially developed honeycomb structure of the cap with integrated shock-absorbing elements ensures complete protection in accordance with EN 812.

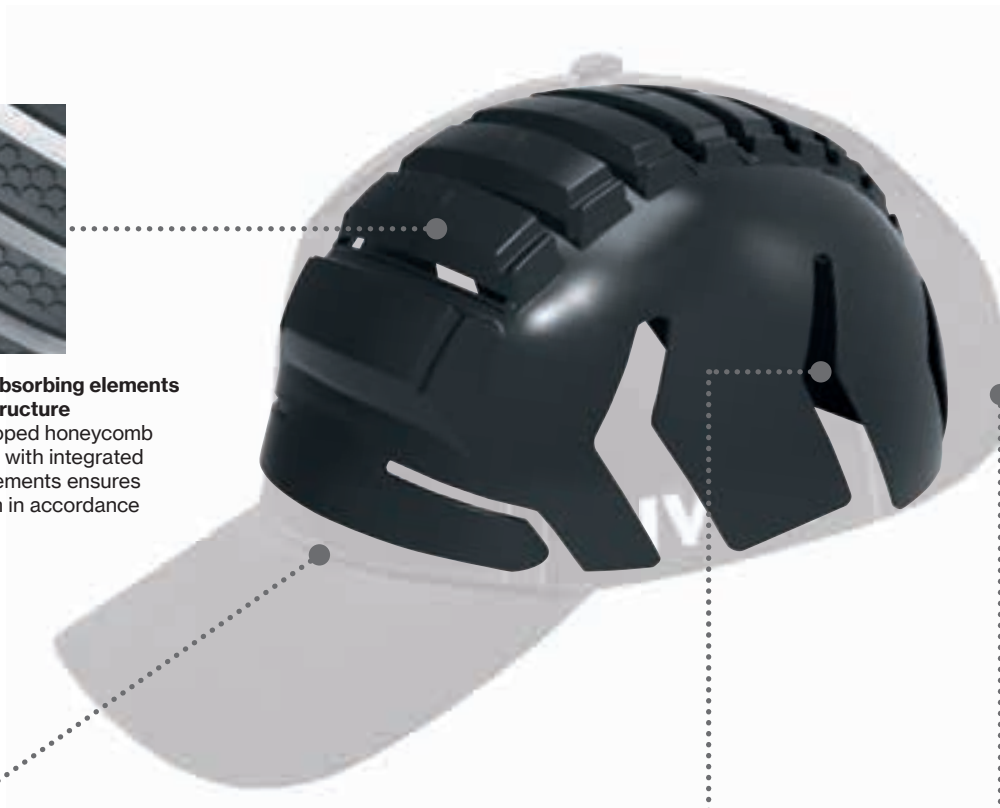

**Armadillo design gives flexibility**

The armadillo design of the uvex u-cap sport provides additional flexibility and ergonomically adapts to different head shapes and sizes. The extended cut-out near the ear makes it easier to wear earmuffs.



**Continuously adjustable**

The uvex u-cap sport can be quickly and easily fitted to the head using the adjustable velcro fastening.

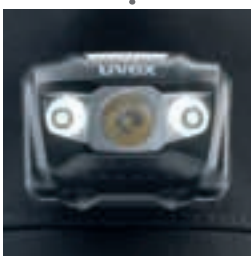

**Magnetic head torch**

- Simple to use: magnetic fixing enables easy attachment and removal from u-cap sport
- The beam can be directed in multiple directions through a moving joint, ensuring optimal illumination
- Switch between various beam types



uvex u-cap sport  
A wide range for many applications



9794400  
9794401  
9794402



9794443  
9794423  
9794425



9794409  
9794403  
9794404



9794442  
9794422  
9794424



9794110

9794415



**LED lamp uvex u-cap sport,  
suitable for all u-cap sport  
variants available on page 118.**

9794111

**uvex u-cap sport**

uvex u-cap sport						
<b>Art. no.</b>	9794409	9794403	9794404	9794442	9794422	9794424
<b>Version</b>	with short brim (4 cm), hard case made of ABS, textile cap made of cotton			with short brim (4 cm) and mesh webbing suspension harness, hard case made of ABS, textile cap made of cotton		
<b>Standard</b>	EN 812	EN 812	EN 812	EN 812	EN 812	EN 812
<b>Colour</b>	black	black	black	black	black	black
<b>Sizes</b>	52 to 54 cm	55 to 59 cm	60 to 63 cm	52 to 54 cm	55 to 59 cm	60 to 63 cm
<b>Order unit</b>	PC	PC	PC	PC	PC	PC
<b>Outer packaging</b>	60 PC per CT	60 PC per CT	60 PC per CT	60 PC per CT	60 PC per CT	60 PC per CT
<b>Art. no.</b>	9794400	9794401	9794402	9794443	9794423	9794425
<b>Version</b>	with long brim (7 cm), hard case made of ABS, textile cap made of cotton			with long brim (7 cm) and mesh webbing suspension harness, hard case made of ABS, textile cap made of cotton		
<b>Standard</b>	EN 812	EN 812	EN 812	EN 812	EN 812	EN 812
<b>Colour</b>	black	black	black	black	black	black
<b>Sizes</b>	52 to 54 cm	55 to 59 cm	60 to 63 cm	52 to 54 cm	55 to 59 cm	60 to 63 cm
<b>Order unit</b>	PC	PC	PC	PC	PC	PC
<b>Outer packaging</b>	60 PC per CT	60 PC per CT	60 PC per CT	60 PC per CT	60 PC per CT	60 PC per CT

**uvex u-cap sport suspension harness**

uvex u-cap sport suspension harness	
<b>Art. no.</b>	9794415
<b>Version</b>	soft, comfortable mesh webbing suspension harness increased wearer comfort in uvex u-cap sport bump caps
<b>Standard</b>	EN 812
<b>Colour</b>	black
<b>Sizes</b>	unisize
<b>Order unit</b>	PC
<b>Outer packaging</b>	60 PC per CT

**Baseball cap**

Baseball cap		
<b>Art. no.</b>	9794110	9794111
<b>Version</b>	with long brim (7 cm) without hard shell element	with short brim (4 cm) without hard shell element
<b>Colour</b>	black	black
<b>Sizes</b>	55 to 63 cm	55 to 63 cm
<b>Order unit</b>	PC	PC
<b>Outer packaging</b>	60 PC per CT	60 PC per CT

## uvex u-cap

uvex u-cap sport · uvex u-cap sport vent · uvex u-cap sport hi-viz



9794407  
9794408



9794430 9794444  
9794420 9794416  
9794421 9794417



9794480  
9794481  
9794482



9794490  
9794491  
9794492



**LED lamp uvex u-cap sport, suitable for all u-cap sport variants available on page 118.**

### uvex u-cap sport

uvex u-cap sport		
<b>Art. no.</b>	9794407	9794408
<b>Version</b>	with long brim (7 cm), hard case made of ABS, textile cap made of cotton	
<b>Standard</b>	EN 812	EN 812
<b>Colour</b>	navy blue	navy blue
<b>Sizes</b>	55 to 59 cm	60 to 63 cm
<b>Order unit</b>	PC	PC
<b>Outer packaging</b>	60 PC per CT	60 PC per CT

### uvex u-cap sport vent

uvex u-cap sport vent			
<b>Art. no.</b>	9794430	9794420	9794421
<b>Version</b>	with short brim (4 cm), hard case made of ABS, textile cap made of cotton and mesh fibre		
<b>Standard</b>	EN 812	EN 812	EN 812
<b>Colour</b>	black	black	black
<b>Sizes</b>	52 to 54 cm	55 to 59 cm	60 to 63 cm
<b>Order unit</b>	PC	PC	PC
<b>Outer packaging</b>	60 PC per CT	60 PC per CT	60 PC per CT
<b>Art. no.</b>	9794444	9794416	9794417
<b>Version</b>	with short brim (4 cm) and mesh webbing and mesh webbing interior, ABS hard shell, textile cap made of cotton and mesh fibre		
<b>Standard</b>	EN 812	EN 812	EN 812
<b>Colour</b>	black	black	black
<b>Sizes</b>	52 to 54 cm	55 to 59 cm	60 to 63 cm
<b>Order unit</b>	PC	PC	PC
<b>Outer packaging</b>	60 PC per CT	60 PC per CT	60 PC per CT

### uvex u-cap sport hi-viz

uvex u-cap sport hi-viz						
<b>Art. no.</b>	9794482	9794480	9794481	9794492	9794490	9794491
<b>Version</b>	with short brim (4 cm), ABS hard shell, textile cap made of cotton in fluorescent colours, according to requirements with EN 471 – increased visibility and security for the user					
<b>Standard</b>	EN 812	EN 812	EN 812	EN 812	EN 812	EN 812
<b>Colour</b>	hi-viz yellow	hi-viz yellow	hi-viz yellow	hi-viz orange	hi-viz orange	hi-viz orange
<b>Sizes</b>	52 to 54 cm	55 to 59 cm	60 to 63 cm	52 to 54 cm	55 to 59 cm	60 to 63 cm
<b>Order unit</b>	PC	PC	PC	PC	PC	PC
<b>Outer packaging</b>	60 PC per CT	60 PC per CT	60 PC per CT	60 PC per CT	60 PC per CT	60 PC per CT

# Safety Helmets

## Overview

Art. no.	Name	Description	Colour	Page
9050517	Accessories	Replacement lens, CA, non-fogging	clear	127/130
9060017	Accessories	Replacement lens, CA	clear	130
9301544	uvex ultravision	Wide-vision goggles with helmet bracket,	grey	130
9302510	uvex ultrasonic	Wide-vision goggles with helmet bracket,	blue, grey	130
9705014	Accessories	Cellulose acetate protective visor	clear	130
9706514	Accessories	Antifog cellulose acetate protective visor,	clear	130
9707014	Accessories	Cellulose acetate protective visor	clear	130
9708514	Accessories	Antifog cellulose acetate protective visor,	clear	130
9723017	Accessories	Replacement lens, PC	clear	127
9725514	Accessories	Antifog cellulose acetate visor	clear	127
9726014	Accessories	Polycarbonate visor	clear	127
9750020	uvex super boss	Safety helmet	white	108
9750120	uvex super boss	Safety helmet	yellow	108
9750520	uvex super boss	Safety helmet	blue	108
9754000	uvex thermo boss	Safety helmet	white	109
9754100	uvex thermo boss	Safety helmet	yellow	109
9754300	uvex thermo boss	Safety helmet	red	109
9760000	Accessories	Conventional suspension harness		116
9760001	Accessories	Suspension harness with rotating size adjusters		116
9760005	Accessories	Sweatband, synthetic leather		116
9760007	Accessories	Sweatband, textile/foam material		116
9760009	Accessories	Sweatband pheos ABS		107/116
9760011	Accessories	Suspension harness		116
9760012	Accessories	Suspension harness		116
9760014	Accessories	Wheel ratchet padding		116
9760106	Accessories	Replacement suspension harness pheos ABS		107
9760107	Accessories	Suspension harness pheos faceguard		129
9760108	Accessories	Sweatband for suspension harness		129
9762020	uvex airwing B	Safety helmet	white	108
9762021	uvex airwing B-S	Safety helmet	white	109
9762030	uvex airwing B-WR	Safety helmet	white	108
9762031	uvex airwing B-S-WR	Safety helmet	white	109
9762120	uvex airwing B	Safety helmet	yellow	108
9762121	uvex airwing B-S	Safety helmet	yellow	109
9762130	uvex airwing B-WR	Safety helmet	yellow	108
9762131	uvex airwing B-S-WR	Safety helmet	yellow	109
9762220	uvex airwing B	Safety helmet	orange	108
9762221	uvex airwing B-S	Safety helmet	orange	109
9762230	uvex airwing B-WR	Safety helmet	orange	108
9762231	uvex airwing B-S-WR	Safety helmet	orange	109
9762320	uvex airwing B	Safety helmet	red	108
9762321	uvex airwing B-S	Safety helmet	red	109
9762330	uvex airwing B-WR	Safety helmet	red	108
9762331	uvex airwing B-S-WR	Safety helmet	red	109
9762420	uvex airwing B	Safety helmet	green	108
9762421	uvex airwing B-S	Safety helmet	green	109
9762430	uvex airwing B-WR	Safety helmet	green	108
9762431	uvex airwing B-S-WR	Safety helmet	green	109
9762520	uvex airwing B	Safety helmet	blue	108
9762521	uvex airwing B-S	Safety helmet	blue	109
9762530	uvex airwing B-WR	Safety helmet	blue	108
9762531	uvex airwing B-S-WR	Safety helmet	blue	109
9762920	uvex airwing B	Safety helmet	black	108
9770020	uvex pheos E	Safety helmet	white	113
9770026	uvex pheos E	Safety helmet with reflective sticker	white	114
9770030	uvex pheos E-WR	Safety helmet	white	113
9770031	uvex pheos E-S-WR	Safety helmet	white	113
9770036	uvex pheos E-WR	Safety helmet with reflective sticker	white	114

Art. no.	Name	Description	Colour	Page
9770120	uvex pheos E	Safety helmet	yellow	113
9770126	uvex pheos E	Safety helmet with reflective sticker	yellow	114
9770130	uvex pheos E-WR	Safety helmet	yellow	113
9770131	uvex pheos E-S-WR	Safety helmet	yellow	113
9770136	uvex pheos E-WR	Safety helmet with reflective sticker	yellow	114
9770230	uvex pheos E-WR	Safety helmet	orange	113
9770231	uvex pheos E-S-WR	Safety helmet	orange	113
9770330	uvex pheos E-WR	Safety helmet	red	113
9770331	uvex pheos E-S-WR	Safety helmet	red	113
9770430	uvex pheos E-WR	Safety helmet	green	113
9770431	uvex pheos E-S-WR	Safety helmet	green	113
9770530	uvex pheos E-WR	Safety helmet	blue	113
9770531	uvex pheos E-S-WR	Safety helmet	blue	113
9770536	uvex pheos E-WR	Safety helmet with reflective sticker	blue	114
9770830	uvex pheos E-WR	Safety helmet	dark grey	113
9770832	uvex pheos E-S-WR	Safety helmet	dark grey	113
9770931	uvex pheos E-S-WR	Safety helmet	black	113
9772001	Accessories	Suspension harness IES		116
9772002	Accessories	Mount		118
9772020	uvex pheos B	Safety helmet	white	112
9772026	uvex pheos B	Safety helmet with reflective sticker	white	114
9772030	uvex pheos B-WR	Safety helmet	white	112
9772031	uvex pheos B-S-WR	Safety helmet	white	112
9772035	uvex pheos B-WR	Safety helmet with reflective sticker	white	114
9772038	uvex pheos B-S-WR	Safety helmet with reflective sticker	white	114
9772040	uvex pheos IES	Safety helmet	white	114
9772071	uvex pheos ABS B-S-WR	Safety helmet	white	107
9772120	uvex pheos B	Safety helmet	yellow	112
9772126	uvex pheos B	Safety helmet with reflective sticker	yellow	114
9772130	uvex pheos B-WR	Safety helmet	yellow	112
9772131	uvex pheos B-S-WR	Safety helmet	yellow	112
9772137	uvex pheos B-S-WR	Safety helmet with reflective sticker	yellow	114
9772138	uvex pheos B-WR	Safety helmet with reflective sticker	yellow	114
9772140	uvex pheos IES	Safety helmet	yellow	114
9772171	uvex pheos ABS B-S-WR	Safety helmet	yellow	107
9772220	uvex pheos B	Safety helmet	orange	112
9772226	uvex pheos B	Safety helmet with reflective sticker	orange	114
9772230	uvex pheos B-WR	Safety helmet	orange	112
9772231	uvex pheos B-S-WR	Safety helmet	orange	112
9772236	uvex pheos B-WR	Safety helmet with reflective sticker	orange	114
9772239	uvex pheos B-S-WR	Safety helmet with reflective sticker	orange	114
9772240	uvex pheos IES	Safety helmet	orange	114
9772271	uvex pheos ABS B-S-WR	Safety helmet	orange	107
9772320	uvex pheos B	Safety helmet	red	112
9772326	uvex pheos B	Safety helmet with reflective sticker	red	114
9772330	uvex pheos B-WR	Safety helmet	red	112
9772332	uvex pheos B-S-WR	Safety helmet	red	112
9772334	uvex pheos B-S-WR	Safety helmet with reflective sticker	red	114
9772340	uvex pheos IES	Safety helmet	red	114
9772371	uvex pheos ABS B-S-WR	Safety helmet	red	107
9772430	uvex pheos B-WR	Safety helmet	green	112
9772437	uvex pheos B-WR	Safety helmet with reflective sticker	green	114
9772520	uvex pheos B	Safety helmet	blue	112
9772526	uvex pheos B	Safety helmet with reflective sticker	red	114
9772530	uvex pheos B-WR	Safety helmet	blue	112
9772531	uvex pheos B-S-WR	Safety helmet	blue	112
9772537	uvex pheos B-S-WR	Safety helmet with reflective sticker	blue	114
9772538	uvex pheos B-WR	Safety helmet with reflective sticker	blue	114



# Safety Helmets

## Overview

Art. no.	Name	Description	Colour	Page
9772540	uvex pheos IES	Safety helmet	blue	114
9772832	uvex pheos B-S-WR	Safety helmet	dark grey	112
9772920	uvex pheos B	Safety helmet	black	112
9772926	uvex pheos B	Safety helmet with reflective sticker	black	114
9772930	uvex pheos B-WR	Safety helmet	black	112
9772932	uvex pheos B-S-WR	Safety helmet	black	112
9772936	uvex pheos B-WR	Safety helmet with reflective sticker	black	114
9773050	uvex pheos alpine	Safety helmet	white	111
9773150	uvex pheos alpine	Safety helmet	yellow	111
9773250	uvex pheos alpine	Safety helmet	orange	111
9773350	uvex pheos alpine	Safety helmet	red	111
9773450	uvex pheos alpine	Safety helmet	green	111
9773550	uvex pheos alpine	Safety helmet	blue	111
9773950	uvex pheos alpine	Safety helmet	black	111
9774236	uvex pheos	Forestry	yellow	107
9774237	uvex pheos	Forestry	orange	107
9774238	uvex pheos	Forestry	red	107
9790000	Accessories	Suspension harness		116
9790004	Accessories	Sweatband, leather		116
9790005	Accessories	Leather chin straps		117
9790006	Accessories	Paper cap	white	115
9790007	Accessories	Forked chin straps		117
9790010	Accessories	Winter cap	black	115
9790012	Accessories	Winter cap	black	115
9790015	Accessories	Winter cap	black	115
9790016	Accessories	Winter cap	black	115
9790018	uvex pheos reflex set M	Reflective set		114
9790021	Accessories	Four-point chin strap		109/116
9790022	Accessories	Goggles clip/chin strap clip		117
9790023	Accessories	Pen holder		117
9790029	Accessories	LED head torch KS-6002-DUO		118
9790035	Accessories	Leather chin straps		117
9790047	Accessories	Helmet bracket	black	127
9790048	Accessories	Visor lens, PC	clear	127
9790062	Accessories	LED head torch pheos Lights		118
9790063	Accessories	LED head torch pheos Lights EX		118
9790064	Accessories	LED head torch u-cap sport		118
9790065	Accessories	Winter cap	hi-viz yellow	115
9790066	Accessories	Balaclava	black	115
9790067	Accessories	Visor adapter	black	126
9790068	Accessories	Winter cap	hi-viz orange	115
9790069	Accessories	Helmet adapter for LED head torch u-cap sport		118
9790071	Accessories	Helmet bag		117
9790074	Accessories	Sunglare filter/rain cover		126/129
9790075	Accessories	Neck protection	orange	115
9790076	Accessories	Neck protection	yellow	115
9790077	Accessories	Helmet slot sealing plug set		117
9790078	Accessories	Helmet adapter		126
9790086	Accessories	cooling neck protection		116
9790146	Accessories	Signal whistle		107
9790149	Accessories	Neck support		117
9790166	Accessories	Business card holder		117
9790210	Accessories	Replacement visor (metal)		109
9790211	uvex pheos faceguard	uvex pheos faceguard face protection system		129
9790212	uvex pheos faceguard	uvex pheos faceguard face protection system with hearing protection		129
9790213	Accessories	V3air rechargeable		118
9790214	Accessories	Universal silicone strap		118
9794110	Baseball cap	with long brim, size 55 – 63 cm	black	135
9794111	Baseball cap	with short brim, size 55 – 63 cm	black	135
9794400	uvex u-cap sport	Impact cap, size 52 – 54 cm	black	135
9794401	uvex u-cap sport	Impact cap, size 55 – 59 cm	black	135
9794402	uvex u-cap sport	Impact cap, size 60 – 63 cm	black	135
9794403	uvex u-cap sport	Impact cap, size 55 – 59 cm	black	135
9794404	uvex u-cap sport	Impact cap, size 60 – 63 cm	black	135
9794407	uvex u-cap sport	Impact cap, size 55 – 59 cm	navy blue	136
9794408	uvex u-cap sport	Impact cap, size 60 – 63 cm	navy blue	136
9794409	uvex u-cap sport	Impact cap, size 52 – 54 cm	black	135
9794415	uvex u-cap sport	Suspension harness	black	135
9794416	uvex u-cap sport vent	Impact cap, size 55 – 59 cm	black	136
9794417	uvex u-cap sport vent	Impact cap, size 60 – 63 cm	black	136
9794420	uvex u-cap sport vent	Impact cap, size 55 – 59 cm	black	136
9794421	uvex u-cap sport vent	Impact cap, size 60 – 63 cm	black	136
9794422	uvex u-cap sport	Impact cap, size 55 – 59 cm	black	135
9794423	uvex u-cap sport	Impact cap, size 55 – 59 cm	black	135
9794424	uvex u-cap sport	Impact cap, size 60 – 63 cm	black	135
9794425	uvex u-cap sport	Impact cap, size 60 – 63 cm	black	135
9794430	uvex u-cap sport vent	Impact cap, size 52 – 54 cm	black	136
9794442	uvex u-cap sport	Impact cap, size 52 – 54 cm	black	135
9794443	uvex u-cap sport	Impact cap, size 52 – 54 cm	black	135
9794444	uvex u-cap sport vent	Impact cap, size 52 – 54 cm	black	136
9794480	uvex u-cap sport hi-viz	Impact cap, size 55 – 59 cm	hi-viz yellow	136
9794481	uvex u-cap sport hi-viz	Impact cap, size 60 – 63 cm	hi-viz yellow	136
9794482	uvex u-cap sport hi-viz	Impact cap, size 52 – 54 cm	hi-viz yellow	136
9794490	uvex u-cap sport hi-viz	Impact cap, size 55 – 59 cm	hi-viz orange	136
9794491	uvex u-cap sport hi-viz	Impact cap, size 60 – 63 cm	hi-viz orange	136
9794492	uvex u-cap sport hi-viz	Impact cap, size 52 – 54 cm	hi-viz orange	136
9906002	Accessories	uvex pheos Visor	clear	124
9906003	Accessories	uvex pheos magnetic Visor	clear	124
9906005	Accessories	uvex pheos SLB 1 Visor	clear	124
9906006	Accessories	uvex pheos SLB 1 magnetic Visor	clear	124
9906007	Accessories	uvex pheos SLB 2 Visor	blue	124
9906008	Accessories	uvex pheos SLB 2 magnetic Visor	blue	124
9906012	Accessories	Replacement lens pheos Visor	clear	124
9906013	Accessories	Replacement lens pheos SLB 1 Visor	clear	124/129
9906017	Accessories	Replacement lens pheos SLB 2 Visor	blue	124
9924010	Accessories	Adapter	black	127
9954362	Accessories	Cloth bag for uvex visors	black	126